

SQUARES K -THEORY AND 2-SEGAL SPACES

MAXINE E. CALLE AND MARU SARAZOLA
WITH AN APPENDIX BY MAXINE E. CALLE

ABSTRACT. We define an S_\bullet -construction for squares categories, and introduce a class of squares categories we call *proto-Waldhausen* which capture the properties required for the S_\bullet -construction to model the K -theory space. The primary question we investigate is when the S_\bullet -construction of a squares category produces a 2-Segal space. We show that the answer to this question is affirmative when the squares category satisfies certain “stability” conditions. In an appendix, we discuss a version of Waldhausen’s additivity theorem for squares K -theory.

CONTENTS

| | |
|--|----|
| 1. Introduction | 1 |
| Acknowledgements | 3 |
| 2. An S_\bullet -construction for squares categories | 3 |
| 2.1. Squares categories | 4 |
| 2.2. The S_\bullet^\square -construction | 10 |
| 2.3. Proto-Waldhausen categories | 14 |
| 2.4. A Waldhausen–Thomason comparison | 17 |
| 3. Connection with 2-Segal objects | 22 |
| 3.1. 2-Segal objects | 23 |
| 3.2. Stable squares categories | 24 |
| 3.3. 2-Segal objects from stable squares categories | 27 |
| Appendix A. A note on Waldhausen’s additivity theorem for squares | 35 |
| A.1. Split squares | 38 |
| A.2. A comparison with Waldhausen additivity | 39 |
| A.3. A discussion of squares additivity for Mfld_d^∂ | 40 |
| References | 42 |

1. INTRODUCTION

Given a category \mathcal{C} , its nerve $N_*\mathcal{C}$ is a simplicial set whose n -simplices are length- n sequences of composable morphisms. The nerve has the extra structure of a 1-*Segal set*, meaning that the *Segal maps*

$$N_n\mathcal{C} \rightarrow N_1\mathcal{C} \times_{N_0\mathcal{C}} \cdots \times_{N_0\mathcal{C}} N_1\mathcal{C}$$

which send an n -simplex to its spine are isomorphisms for $n \geq 2$. In fact, this property completely characterizes nerves: a simplicial set is 1-Segal if and only if it is isomorphic to the nerve of some category. In particular, any 1-Segal set X has a composition map given by

$$X_1 \times_{X_0} X_1 \xleftarrow{\cong} X_2 \xrightarrow{d_1} X_1$$

and relationships between higher simplicies encode the fact that this composition is associative.

Date: September 26, 2024.

2020 Mathematics Subject Classification. 19D99, 18N10, 55U10, 18G90.

Key words and phrases. 2-Segal spaces, squares K -theory, Waldhausen S_\bullet -construction, double categories.

One can consider a higher-dimensional version of the Segal condition on a simplicial set X , by instead requiring that the maps

$$X_n \rightarrow X_2 \times_{X_1} \cdots \times_{X_1} X_2$$

be isomorphisms for all $n \geq 3$. This gives rise to the notion of *2-Segal sets* (also known as *decomposition spaces*), introduced by Dyckerhoff and Kapronov [DK19] and Gálvez-Carrillo, Kock, and Tonks [GKT18]. A 2-Segal set may not have a well-defined composition, but in some sense remembers the higher-dimensional data of associativity. This structure can be thought of as an associative multi-valued composition (as explained in [Ber+18]) or as an A_∞ -algebra structure in a category of spans of sets [Ste19]. In fact, this notion can be defined more generally in the setting of simplicial *objects* in any category \mathcal{C} . When \mathcal{C} is the category of topological spaces, the natural requirement is for the Segal maps to be weak homotopy equivalences, and we obtain the notion of *2-Segal space*.

Just like all 1-Segal sets can be obtained as nerves, 2-Segal sets are the natural output of the S_\bullet -construction, which was introduced by Waldhausen [Wal83] in the context of higher algebraic K -theory. Indeed, in [Ber+18], Bergner, Osorno, Ozornova, Rovelli, and Scheimbauer show that every 2-Segal set arises from a version of the S_\bullet -construction, by replacing the classical K -theoretical inputs with a different categorical structure called *stable augmented double categories*. A similar result also holds for the case of 2-Segal spaces, where it was long understood that the S_\bullet -construction of certain kinds of input categories, such as the *proto-exact categories* of [DK19], has the structure of a 2-Segal space. Although not every Waldhausen category will produce a 2-Segal space, every 2-Segal space can be obtained as the S_\bullet -construction applied to a topological generalization of stable augmented double categories [Ber+21].

In this paper, we continue the study of the strong connection between 2-Segal objects and higher algebraic K -theory. The stable augmented double categories of [Ber+18] are examples of *squares categories*, a framework introduced in [Cam+23] to carry out new investigations related to the K -theory of varieties [Cam19; CZ24] and scissors congruence problems [Zak12; Mal23; Hoe+22; CZ22]. The central question of this paper is: when does the K -theory construction of a squares category produce a Segal object?

The K -theory of a squares category is given by a double-nerve construction, also called the T_\bullet -construction. The name is inspired by the *Thomason construction* for Waldhausen categories (see [Wal83, Section 1.3]) which provides another model for the K -theory of a Waldhausen category equivalent to the one constructed via S_\bullet . Although $T_\bullet \mathcal{C}$ describes a 1-Segal object in Cat (see Remark 2.10), in most cases it does not produce a 2-Segal space.

In this paper, we introduce a S_\bullet -construction for squares categories, denoted S_\bullet^\square , which can produce 2-Segal spaces. Our first result is give sufficient conditions for the S_\bullet^\square -construction to coincide with the T_\bullet -construction.

Theorem A (Theorem 2.53 and Proposition 3.6). *There is a functor*

$$S_\bullet^\square: \text{SqCat} \rightarrow \text{sCat}$$

from the category of squares categories to the category of simplicial categories such that:

- (a) *When the input is a proto-Waldhausen category in the sense of Definition 2.38, then there is an equivalence of spaces*

$$\Omega|S_\bullet^\square \mathcal{C}| \simeq K^\square(\mathcal{C})$$

with the square K -theory defined in [Cam+23].

- (b) *When the input is a pointed stable double category in the sense of [Ber+18], the composition of functors*

$$\text{SqCat} \xrightarrow{S_\bullet^\square} \text{sCat} \xrightarrow{\text{ob}} \text{sSet}$$

is the S_\bullet -construction of [Ber+18].

This S_{\bullet}^{\square} -construction is also closely related to that of another double-categorical structure for K -theory: ECGW-categories. Every ECGW-category \mathbb{C} can be considered as a squares category UC , and the simplicial category $S_{\bullet}^{\square}UC$ defined in this paper is the underlying vertical category of the simplicial double category $S_{\bullet}\mathbb{C}$ of [SS21]. As similar investigations are the subject of ongoing work by other authors, we do not pursue this connection further here.

Inspired by the definitions from [Ber+18], we then introduce an additional stability condition for squares categories (Definition 3.9). The resulting *stable squares categories* behave similarly to the stable (pointed) double categories of [Ber+18], but with weak equivalences as in a Waldhausen category. Every stable pointed double category in the sense of [Ber+18] is a stable squares category whose weak equivalences are equalities (Proposition 3.11).

A stable squares category \mathbb{C} is *isostable* when these weak equivalences are invertible and \mathbb{C} satisfies an additional double-categorical condition that ensures $S_{\bullet}^{\square}\mathbb{C}$ is a simplicial groupoid (see Definition 3.20 and Lemma 3.21). Examples include polytopes and isometries and finitely-generated projective R -modules and isomorphisms. Mirroring the setting for proto-exact categories [DK19, Section 2.4], we show that the S_{\bullet}^{\square} -construction of an isostable squares category produces a 2-Segal space.

Theorem B (Theorem 3.30). *If \mathbb{C} is an isostable squares category, then $[n] \mapsto BS_n^{\square}\mathbb{C}$ is a 2-Segal space.*

Finally, Appendix A includes a discussion on how Waldhausen’s additivity theorem, which states that cofiber sequences of exact functors split after K -theory, could be stated in this double-categorical setting. While we can form analogous statements to Waldhausen’s, it appears that the nature of squares K -theory might be better suited for a different formulation of the additivity theorem.

Acknowledgements. We are delighted to acknowledge that this work began at the “Higher Segal Spaces and their Applications to Algebraic K -Theory, Hall Algebras, and Combinatorics” workshop at the Banff International Research Station, where we first started to wonder about the connection between 2-Segal spaces and squares K -theory. We would also like to thank Julie Bergner and Cary Malkiewich for helpful conversations and feedback. The first-named author was partially supported by NSF grant DGE-1845298.

The appendix, written by the first author, is based on joint work with Liam Keenan, particularly the philosophical perspective of split squares. Their collaboration grew out of conversations from the 2022 Talbot Workshop (which was supported by NSF grant DMS-1953947) and they are very grateful to Jonathan Campbell and Inna Zakharevich for their feedback and suggestions. The first author would also like to thank Cary Malkiewich, Andres Mejia, Mona Merling, Maximilien Péroux, and Maru Sarazola for helpful conversations about squares additivity.

2. AN S_{\bullet} -CONSTRUCTION FOR SQUARES CATEGORIES

Waldhausen’s S_{\bullet} -construction [Wal83] takes as input a *Waldhausen category*, which is a pointed category with a notion of cofibration (\twoheadrightarrow) and weak equivalence ($\xrightarrow{\sim}$) satisfying certain compatibility axioms. In particular, pushouts along cofibrations exist, meaning that certain spans can be completed to squares

$$\begin{array}{ccc} A \twoheadrightarrow B & & A \twoheadrightarrow B \\ \downarrow & \rightsquigarrow & \downarrow \quad \downarrow \\ C & & C \twoheadrightarrow C \cup_A B \end{array} .$$

Taking $C = *$ to be the zero object, this condition implies that every cofibration $A \twoheadrightarrow B$ admits a quotient $B/A = * \cup_A B$. The S_{\bullet} -construction of a Waldhausen category \mathbb{C} produces a simplicial category whose objects are sequences of cofibrations $* \twoheadrightarrow C_1 \twoheadrightarrow \dots \twoheadrightarrow C_n$

along with compatible choices of quotients C_{ij} for each $C_i \twoheadrightarrow C_j$. Morphisms are natural transformations that are pointwise valued in weak equivalences, and $K(\mathcal{C})$ is defined to be the based loop space of the realization of this simplicial category. A characterizing feature of the S_\bullet -construction is that it splits the cofiber sequences in \mathcal{C} ; this feature can be seen directly at the level of $K_0(\mathcal{C}) = \pi_0(K(\mathcal{C}))$ where $[B] = [A] + [B/A]$ whenever $A \twoheadrightarrow B$, and more abstractly via Waldhausen’s additivity theorem [Wal83] and the universal property captured in [BGT13].

There is another model for the K -theory of a Waldhausen category \mathcal{C} , called the *Thomason construction* (see [Wal83, Section 1.3]), which is constructed by associating \mathcal{C} to a certain double category whose horizontal morphisms are cofibrations, vertical morphisms are any morphisms in \mathcal{C} , and squares are pushouts up to weak equivalence, i.e. commutative diagrams

$$\begin{array}{ccc} A & \twoheadrightarrow & B \\ \downarrow & & \downarrow \\ C & \twoheadrightarrow & D \end{array}$$

such that the induced map $C \cup_A B \rightarrow D$ is a weak equivalence. In the Thomason construction, the three term relation $[B] = [A] + [B/A]$ is replaced with a four term relation $[D] = [B] + [C] - [A]$.

The idea of using a K -theory construction that encodes four term relations (or an inclusion-exclusion principle more generally) is the impetus for the introduction of *squares categories* [Cam+23] and their K -theory. A squares category is a type of double category, meaning that there are two different kinds of morphisms, horizontal (\twoheadrightarrow) and vertical (\twoheadrightarrow), as well as squares

$$\begin{array}{ccc} A & \twoheadrightarrow & B \\ \downarrow & \square & \downarrow \\ C & \twoheadrightarrow & D \end{array}$$

which are 2-cells that encode the interaction between the two different kinds of morphisms. The K -theory of a squares category is the loop space of the realization of its double nerve, based at some distinguished object O . Under mild assumptions, the connected components of this space naturally encode the four-term relation $[D] = [B] + [C] - [A]$, just as in the Thomason construction.

Four-term relations arise naturally in many examples of interest in scissors congruence K -theory, such as total scissors congruence of polytopes, cut-and-paste groups of manifolds [Hoe+22], and certain versions of the Grothendieck spectrum of varieties. Many cases of interest arise from an ambient 1-category \mathcal{C} by selecting certain maps in \mathcal{C} to go in the horizontal and vertical directions and specifying the data of certain squares; this notion is called the *squares category generated by \mathcal{C}* in [Cam+23] and a *category with squares* in [Hoe+22]. One benefit of the formalism of double categories is to account for other examples (e.g. when the vertical morphisms are a subset of morphisms in \mathcal{C}^{op}).

In this section, we define a version of S_\bullet -construction for squares categories (Definition 2.20), which we denote S_\bullet^\square . Our definition is a double-categorical version of Waldhausen’s construction, but also encompasses Campbell’s variation for subtractive Waldhausen categories [Cam19]. In general, the S_\bullet^\square -construction of a squares category will not model its K^\square -theory, unless there is an underlying “three-term”-ness; we identify sufficient conditions for the K^\square -theory of a squares category to be modeled by the S_\bullet^\square -construction, following the Waldhausen-Thomason comparison (Theorem 2.53). These kinds of squares categories, which we call *pseudo-Waldhausen categories* (Definition 2.38), are the basis for the stable squares categories that we introduce in Section 3.

2.1. Squares categories. We first recall the definition of a squares category, along with the corresponding K -theory construction. More details, as well as examples, can be found in

[Cam+23]. Squares categories rely on the notion of a double category, so we start with a brief recollection of these 2-dimensional structures. However, we will assume a certain familiarity with double categories, and direct the reader to [Gra19, Chapter 3] for detailed definitions.

Definition 2.1. A *double category* is an internal category to \mathbf{Cat} , the category of small categories and functors. More explicitly, a double category \mathbb{A} consists of objects A, B, A', B', \dots , horizontal morphisms $A \multimap B$, vertical morphisms $A \twoheadrightarrow A'$, and squares

$$\begin{array}{ccc} A & \multimap & B \\ \downarrow & \Downarrow & \downarrow \\ A' & \multimap & B' \end{array}$$

together with associative and unital compositions for horizontal morphisms, vertical morphisms, and squares. A *double functor* $F: \mathbb{A} \rightarrow \mathbb{B}$ is an assignment on objects, horizontal morphisms, vertical morphisms, and squares that preserves all compositions and identities strictly.

Note that each double category \mathbb{A} has an *underlying horizontal category* $\mathcal{H}_{\mathbb{A}}$ obtained by considering the objects and horizontal morphisms in \mathbb{A} , and an *underlying vertical category* $\mathcal{V}_{\mathbb{A}}$ obtained by considering the objects and vertical morphisms in \mathbb{A} .

Definition 2.2. A double category is *flat* if the squares are uniquely determined by their boundary.

Notation. Since all double categories in this paper are flat, we will use the symbol

$$\begin{array}{ccc} A & \multimap & B \\ \downarrow & \square & \downarrow \\ A' & \multimap & B' \end{array}$$

to indicate that the given boundary determines a square in the double category. This is in line with the fact that being a square is property rather than data, and is the notation used in [Cam+23].

We now recall the notions of horizontal and vertical natural transformations, specialized to the case of flat double categories. A general definition requires additional coherences which are automatic in the flat case, and can be found in [Gra19, §3.2.7].

Definition 2.3. Let $F, G: \mathbb{A} \rightarrow \mathbb{B}$ be two double functors between flat double categories. A *vertical natural transformation* $\tau: F \Rightarrow G$ is the data of a vertical morphism $\tau_A: F(A) \twoheadrightarrow G(A)$ in \mathbb{B} for each object $A \in \mathbb{A}$, such that for each horizontal morphism $f: A \multimap A'$ in \mathbb{A} the boundary below left determines a square in \mathbb{B} ,

$$\begin{array}{ccc} F(A) & \xrightarrow{Ff} & F(A') \\ \tau_A \downarrow & \square & \downarrow \tau_{A'} \\ G(A) & \xrightarrow{Gf} & G(A') \end{array} \qquad \begin{array}{ccc} F(A) & \xrightarrow{Fu} & F(A') \\ \tau_A \downarrow & & \downarrow \tau_{A'} \\ G(A) & \xrightarrow{Gu} & G(A') \end{array}$$

and such that for each vertical morphism $u: A \twoheadrightarrow A'$ in \mathbb{A} the diagram above right commutes in the underlying vertical category of \mathbb{B} .

We denote by $\mathbf{Fun}^v(\mathbb{A}, \mathbb{B})$ the category of double functors from \mathbb{A} to \mathbb{B} and vertical natural transformations. Dually, one can define a *horizontal natural transformation*, and obtain a category $\mathbf{Fun}^h(\mathbb{A}, \mathbb{B})$.

Definition 2.4. A double category \mathbb{C} is *pointed* if there is a distinguished object O which is initial in $\mathcal{H}_{\mathbb{C}}$ and terminal in $\mathcal{V}_{\mathbb{C}}$. A morphism of pointed double categories is a double functor that preserves the distinguished object.

We can now recall the notion of a squares category.

Definition 2.5. A *squares category* is a flat, pointed double category and a functor of squares categories is a pointed double functor.

Remark 2.6. The reader familiar with the original definition introduced in [Cam+23] may recall that they require the basepoint O to be initial in both the horizontal and vertical directions. The two definitions of squares categories are not equivalent categorically, but they are in a K -theoretical sense. Indeed, as we will see below, the K -theory space of a squares category is obtained through a nerve construction which is invariant with respect to reversing the direction of the horizontal or vertical maps. Hence, any squares category in the sense of [Cam+23] can be turned into a squares category in the sense of Definition 2.5 by taking the opposite vertical category (and vice versa), and both structures will produce the same K -theory.

Definition 2.7. Given a squares category \mathbb{C} , we denote by $T_n\mathbb{C}$ the category whose objects are sequences of composable horizontal morphisms in \mathbb{C}

$$C_0 \rightrightarrows C_1 \rightrightarrows C_2 \rightrightarrows \dots \rightrightarrows C_n$$

and whose morphisms are pastings of squares in \mathbb{C}

$$\begin{array}{ccccccccccc} C_0 & \rightrightarrows & C_1 & \rightrightarrows & C_2 & \rightrightarrows & \dots & \rightrightarrows & C_n \\ \downarrow & \square & \downarrow & \square & \downarrow & \square & & \square & \downarrow \\ C'_0 & \rightrightarrows & C'_1 & \rightrightarrows & C'_2 & \rightrightarrows & \dots & \rightrightarrows & C'_n \end{array} .$$

These assemble into a simplicial category $T_\bullet\mathbb{C}$, where all faces and degeneracies behave like the ones in a nerve construction.

Definition 2.8. The K -theory space of a squares category \mathbb{C} is

$$K^\square(\mathbb{C}) = \Omega_O |T_\bullet(\mathbb{C})|,$$

and the K -groups of \mathbb{C} are the homotopy groups of $K^\square(\mathbb{C})$

$$K_i^\square(\mathbb{C}) = \pi_i(K^\square(\mathbb{C})).$$

Remark 2.9. The construction of $T_\bullet\mathbb{C}$ presented above is precisely the *horizontal nerve* of the underlying double category \mathbb{C} . In [Cam+23], the authors define the K -theory space of a squares category using the *double nerve* of \mathbb{C} instead: the bisimplicial set whose (m, n) -simplices are pastings of squares in \mathbb{C} of the form

$$\begin{array}{ccc} C_{00} & \rightrightarrows \dots \rightrightarrows & C_{0n} \\ \downarrow & \square & \downarrow \\ \vdots & \ddots & \vdots \\ \downarrow & & \downarrow \\ C_{m0} & \rightrightarrows \dots \rightrightarrows & C_{mn} \end{array}$$

All nerves of double categories produce the same space up to homeomorphism, so these constructions are equivalent at the K -theory level; our choice to present the space via a simplicial category instead of a bisimplicial set is motivated by our ultimate goal of comparing it to an S_\bullet -construction.

Remark 2.10. Note that the simplicial category $[n] \mapsto T_n\mathbb{C}$ is a 1-Segal object in Cat with the canonical model structure. However, the simplicial space $[n] \mapsto BT_n\mathbb{C}$ may not be 1-Segal as taking classifying spaces will generally not preserve homotopy pullbacks. Additionally, we note that the double nerve is neither a 1-Segal set nor a 2-Segal set in general.

Under an additional condition we recover the expected description of $K_0^\square(\mathbb{C})$ as a Grothendieck group.

Theorem 2.11 ([Cam+23, Theorem 3.1]). *Suppose a squares category \mathbb{C} is such that for any two objects A, B there is an object X and squares*

$$\begin{array}{ccc} A & \twoheadrightarrow & X \\ \downarrow & \square & \downarrow \\ O & \twoheadrightarrow & B \end{array} \quad \text{and} \quad \begin{array}{ccc} B & \twoheadrightarrow & X \\ \downarrow & \square & \downarrow \\ O & \twoheadrightarrow & A \end{array} .$$

Then $K_0^\square(\mathbb{C}) \cong \mathbb{Z}[\text{ob } \mathbb{C}] / \sim$ where $[O] \sim 0$ and $[A] + [D] = [B] + [C]$ for every square

$$\begin{array}{ccc} A & \twoheadrightarrow & B \\ \downarrow & \square & \downarrow \\ C & \twoheadrightarrow & D \end{array} .$$

Example 2.12 ([Cam+23, Example 1.8]). Any Waldhausen category \mathcal{C} gives rise to a squares category, in which the objects are the objects of \mathcal{C} , the horizontal morphisms are the cofibrations in \mathcal{C} , the vertical morphisms are all the morphisms in \mathcal{C} , and where a commutative diagram

$$\begin{array}{ccc} A & \twoheadrightarrow & B \\ \downarrow & & \downarrow \\ C & \twoheadrightarrow & D \end{array}$$

is a square in the double category if the induced map from the pushout $B \sqcup_A C \rightarrow D$ is a weak equivalence. The basepoint O is the zero object of \mathcal{C} .

The K -theory of this squares category is precisely the Thomason model for the K -theory of the Waldhausen category \mathcal{C} , which agrees with the space obtained through the classical S_\bullet -construction as explained in [Wal83, Section 1.3].

Example 2.13 ([Cam+23, Example 1.12]). The category FinSet of finite sets admits a squares structure where horizontal morphisms are injections, vertical morphisms are opposites of injections, and squares are underlying pushout squares. The distinguished object is the empty set.

Example 2.14. Let G be a subgroup of the group of isometries of \mathbb{R}^n . There is a squares category \mathbb{P}_G^n whose objects are polytopes in \mathbb{R}^n , where a polytope is a finite union of n -simplices in \mathbb{R}^n (see [Mal23, Section 2.1] for a more detailed definition). The horizontal morphisms are inclusions in \mathbb{R}^n of the form $g \cdot P \subseteq Q$ where $g \in G$ is an isometry, and the vertical morphisms are opposites of these. The distinguished object is the empty set, and a square

$$\begin{array}{ccc} P & \xrightarrow{g_0} & Q \\ g_1^{\text{op}} \downarrow & & \downarrow g_3^{\text{op}} \\ Q' & \xrightarrow{g_2} & R \end{array}$$

is an underlying commutative square so that $Q' = g_1^{-1}P \cap g_2^{-1}R$ and $g_0P \cup_{g_0g_1Q'} g_3R = Q$. We emphasize that the intersection is taken in the category of polytopes and the union is

taken as subsets of \mathbb{R}^n , so for example, the following is a square

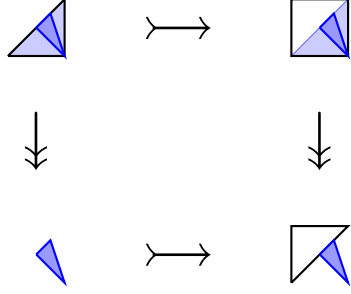

even though the intersection of P and R as subsets of \mathbb{R}^2 would include the entire diagonal line of the square.

Example 2.15. In [Hoe+22], Hoekzema–Merling–Murray–Rovi–Semikina define a category Mfld_d^∂ with squares whose K_0^\square is an SK -group for manifolds with boundary; these groups encode how manifolds of a fixed dimension may be “cut up” and “pasted” back together [Kar+73]. The objects of Mfld_d^∂ are compact, orientable d -manifolds with boundary and $\mathcal{H}\text{Mfld}_d^\partial = \mathcal{V}\text{Mfld}_d^\partial = \text{Hom}(\text{Mfld}_d^\partial)$ are SK -embeddings, which are embeddings with an additional condition on the boundary (see [Hoe+22, Definition 4.1]). The distinguished object is the empty manifold \emptyset and squares are pushout squares.

In order to make Mfld_d^∂ a squares category in the sense of Definition 2.5, we need to take opposites of the vertical morphisms so that \emptyset is initial in horizontal morphisms and terminal in vertical ones. As noted in Remark 2.6, this change does not affect the resulting K -theory space. For clarity, we will denote this squares category $\widetilde{\text{Mfld}}_d^\partial$ to distinguish it from the original definition.

The next few examples are from [Ber+18, Section 7].

Example 2.16 ([Ber+18, Example 7.1]). A *partial monoid* is a set M with a *partial operation* $*$: $M_2 \rightarrow M$ for some $M_2 \subseteq M \times M$. This partial operation is required to have a unit $1 \in M$ and be associative when defined (c.f. [Ber+18, Example 2.1]). The *nerve* of a partial monoid is the simplicial set $N_\bullet M$ with $N_0 M = \{1\}$, $N_1 M = M$, and for $k \geq 1$, $N_k M \subseteq M^{\times k}$ are the composable k -tuples, i.e. those (m_1, \dots, m_k) so that $(m_1 * \dots * m_i, m_{i+1}) \in M_2$ for all i . The face maps apply the operation $*$ in the appropriate slot and the degeneracies insert the unit. The *classifying space* BM is the realization of this simplicial set.

There is a squares category \mathbb{M} whose K^\square -theory space is ΩBM . The objects of \mathbb{M} are the elements $m \in M$ and the distinguished object is the unit. Horizontal and vertical morphisms are witnessed by right- and left-multiplication, respectively

$$a \succ \xrightarrow{(a,b) \in M_2} a * b \quad \text{and} \quad a * b \xrightarrow{(a,b) \in M_2} \twoheadrightarrow b$$

and squares witness the associativity of $*$,

$$\begin{array}{ccc} c * a & \xrightarrow{(c*a,b) \in M_2} & c * a * b \\ \downarrow (c,a) \in M_2 & \square & \downarrow (c,a*b) \in M_2 \\ a & \xrightarrow{(a,b) \in M_2} & a * b \end{array}$$

To see that $K^\square(\mathbb{M}) \cong \Omega BM$, observe that the double nerve $\mathbb{N}\mathbb{M}$ is isomorphic as a simplicial set to the edgewise subdivision of $N_\bullet M$. Hence

$$|T_\bullet \mathbb{M}| \cong |\mathbb{N}\mathbb{M}| \cong |sd(N_\bullet M)| \cong BM$$

using the fact that the edgewise subdivision of a simplicial set does not change its geometric realization [Seg73].

Example 2.17. As a slight generalization of the previous example, from any category \mathcal{C} we can construct a squares category \mathbb{C} whose K^\square -theory space is $\Omega_c B\mathcal{C}$, where $c \in \text{ob } \mathcal{C}$ is any object. Note that $\text{Hom}(\mathcal{C})$ is almost a partial monoid (whose operation is composition), but there is not a unique unit. However, an analogous definition of \mathbb{C} as above works in this setting as the distinguished object is only needed to take based loops. The objects of \mathbb{C} are the morphisms $\text{Hom}(\mathcal{C})$, the horizontal and vertical morphisms witness composition,

$$f \xrightarrow{(f,g) \in N_2 \mathcal{C}} fg \quad \text{and} \quad fg \xrightarrow{(f,g) \in N_2 \mathcal{C}} g$$

and squares witness associativity of composition. Then $T_\bullet \mathbb{C}$ is isomorphic to the edgewise subdivision of $N_\bullet \mathcal{C}$ (or equivalently the nerve of the twisted arrow category), and so $|T_\bullet \mathbb{C}| \cong B\mathcal{C}$. Then, for any object $c \in \mathcal{C}$, we can declare c to be distinguished in \mathbb{C} and take based loops

$$K^\square(\mathbb{C}) = \Omega_c |T_\bullet \mathbb{C}| \cong \Omega_c B\mathcal{C}.$$

Example 2.18. Let Cob_d denote the cobordism category whose objects are closed $(d - 1)$ -manifolds and morphisms are cobordisms between them (see [Koc03]). As described above, there is a squares category \mathbb{C}_d whose objects are d -dimensional cobordisms (remembering the in-boundaries and out-boundaries) and whose squares look like those pictured below (for $d = 2$):

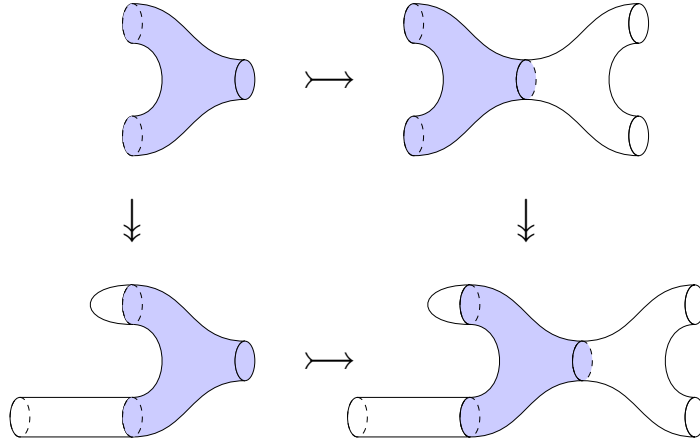

For any $g \geq 0$, we may consider the subcategory $\text{Cob}_d^{\leq g}$ where the morphisms have genus $\leq g$. Repeating the construction above gives a squares category $\mathbb{C}_d^{\leq g}$ for each $g \geq 0$; this is [Ber+18, Example 7.2].

Example 2.19. There are several ways to obtain a squares category from graphs:

- (1) The double category of graphs described in [Ber+18, Example 7.3] is a squares category. For a fixed ambient graph G , the objects of this double category are subgraphs $H \hookrightarrow G$, horizontal morphisms are full subgraph inclusions ($\text{rel } G$) and vertical morphisms are opposites of full subgraph inclusions ($\text{rel } G$). Note that a full subgraph inclusion $H' \hookrightarrow H$ is equivalently specified by a partition $V(H) = V(H') \amalg V(H')^c$. Squares are as described in [Ber+18, Example 7.3], specified by a partition of vertices

into three pieces; for instance,

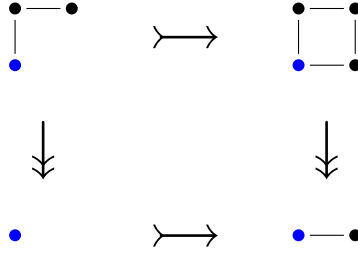

is a square and the corresponding partition of vertices is

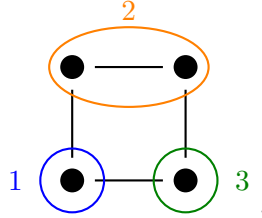

- (2) As in the previous example, horizontal morphisms are subgraph inclusions, vertical morphisms are opposites of subgraph inclusions, and squares are underlying commutative diagrams which are pushouts on the sets of vertices. The difference is that we are not working relative to a fixed graph G .
- (3) Horizontal morphisms are subgraph inclusions, vertical morphisms are opposites of subgraph inclusions, and squares are underlying pushouts in the category of finite graphs. The K^\square -theory of this squares category should essentially be the K -theory of the category with covering families from [CG24, Definition 3.6]. However, there is no comparison between square K -theory and the K -theory for categories with covering families at this time, although it is likely one could pursue such a comparison using ideas of [Wal83, Section 1.8].

2.2. The S_\bullet^\square -construction. Every squares category admits a version of the S_\bullet -construction, obtained by simply considering diagrams of the appropriate shape. However, in general this construction may not model their K -theory space as given in Definition 2.8. In this section we explain how to extract a class of weak equivalences from the data present in a squares category, and we define an S_\bullet^\square -construction analogous to the one for Waldhausen categories. In later subsections we will discuss the requirements needed on a squares category to ensure the two simplicial constructions agree after realization.

Notation. For any $n \geq 0$, let S_n^\square denote the (flat) double category generated by the data

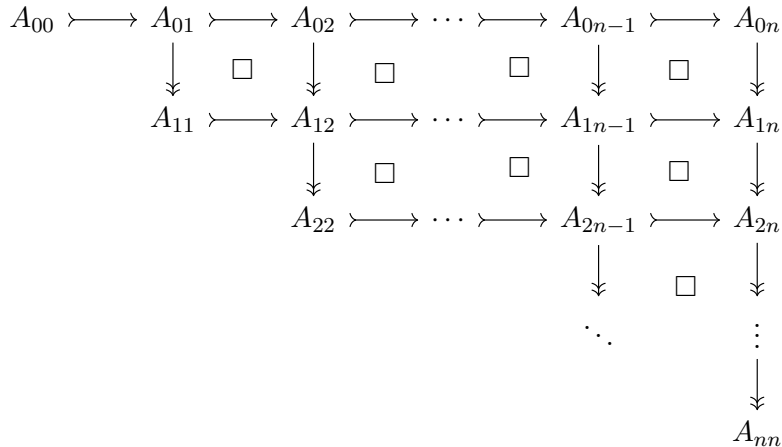

Definition 2.20. Given a squares category \mathbb{C} and $n \geq 0$, we define $S_n^\square \mathbb{C}$ as the subcategory of $\text{Fun}^v(S_n^\square, \mathbb{C})$ whose objects are the functors $F: S_n^\square \rightarrow \mathbb{C}$ such that $F(A_{ii}) = O$ for all i , and morphisms are vertical natural transformations. Then $S_\bullet^\square \mathbb{C}$ forms a simplicial category, where the face map d_i removes the i th row and column (and composes when appropriate) and degeneracy maps simply insert identity maps and identity squares.

It is straightforward to check that this definition extends to a functor between squares categories and simplicial categories.

Proposition 2.21. *The S_\bullet^\square -construction defines a functor $S_\bullet^\square: \text{SqCat} \rightarrow \text{sCat}$.*

Remark 2.22. In some examples, it seems natural to relax the condition in [Definition 2.20](#) that $F(A_{ii}) = O$ and instead ask that $F(A_{ii}) \in \mathcal{A}$ for all i , where \mathcal{A} is some distinguished collection of objects. One could define a notion of *augmented squares category*, similar to an *augmented double category* described in [\[Ber+18, Definition 3.6 and Proposition 3.8\]](#), and define an S_\bullet -construction for such squares categories.

Although we do not pursue this idea in this paper, one can see how it is the natural framework to capture certain examples. For instance, one can encode the K -theory of graphs considered in [\[Bro+24\]](#) using an augmented squares category, by letting horizontal morphisms be subgraph inclusions which are bijections on vertices, vertical morphisms be maps which contract some collection of edges and are bijections on connected components, and squares be pushouts. The different notions of weak equivalence outlined in [\[Bro+24, Definition 5.4\]](#) can be incorporated into a squares category by asking for squares to be pushouts up to the corresponding notion of weak equivalence. This squares category does not have a distinguished initial/terminal object, but instead, a collection of such objects (the discrete sets).

Example 2.23. Let us depict explicitly what the objects and morphisms in the category $S_2^\square \mathbb{C}$ look like. An object consists of a pasting diagram in \mathbb{C} of the form

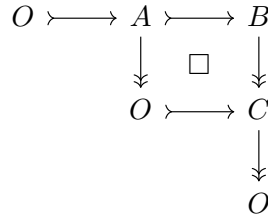

A morphism consists of a diagram

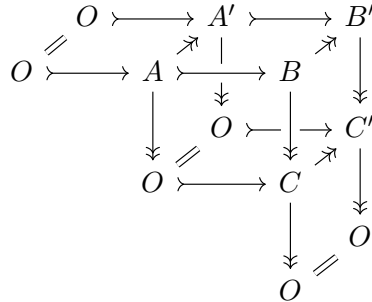

where any square whose boundary has two horizontal and two vertical morphisms is a square in \mathbb{C} , and any square whose boundary consists of four vertical morphisms is a commutative diagram in the underlying vertical category of \mathbb{C} .

Remark 2.24. Unlike the classical S_\bullet -construction for Waldhausen categories, there is a choice required in our definition of $S_\bullet^\square \mathbb{C}$: since we do not assume that there is an ambient (1-)category from which \mathbb{C} arises, we can no longer speak of “natural transformations”, and

instead must decide to use either horizontal or vertical natural transformations¹. The theory could be analogously developed for horizontal ones; our vertical bias is due to the fact that this is what fits many motivating examples. We will see a similar bias again in [Definition 2.38](#).

Remark 2.25. The definition above is what motivates our requirement in [Definition 2.5](#) that O be terminal in vertical morphisms instead of initial. In many examples of interest the distinguished object is initial in vertical morphisms, but as previously mentioned in [Remark 2.6](#), this problem can be circumvented by taking the opposites of vertical arrows.

In the classical S_\bullet -construction for Waldhausen categories, one must restrict the natural transformations to those that are pointwise weak equivalences in order to construct the K -theory space. To make an analogous restriction possible in our setting, we now identify a notion of horizontal and vertical weak equivalence, encoded by the squares.

Definition 2.26. Let \mathbb{C} be a squares category. A horizontal morphism $A \twoheadrightarrow B$ is a *horizontal weak equivalence* if it participates in a square

$$\begin{array}{ccc} A & \twoheadrightarrow & B \\ \downarrow & \square & \downarrow \\ O & \xlongequal{\quad} & O \end{array}$$

Similarly, define *vertical weak equivalences* to be the vertical morphisms $A \twoheadrightarrow B$ that participate in a square

$$\begin{array}{ccc} O & \twoheadrightarrow & A \\ \parallel & \square & \downarrow \\ O & \twoheadrightarrow & B \end{array}$$

Denote these collections of morphisms by $w^h\mathbb{C} \subseteq \mathcal{H}_{\mathbb{C}}$ and $w^v\mathbb{C} \subseteq \mathcal{V}_{\mathbb{C}}$, respectively.

Remark 2.27. By definition, the pointwise vertical maps appearing in a morphism in the category $S_\bullet^{\square}\mathbb{C}$ are all in $w^v\mathbb{C}$. To illustrate this in the case of $n = 2$ of [Example 2.23](#), we see that $A \twoheadrightarrow A'$ and $C \twoheadrightarrow C'$ are weak equivalences directly by definition, and the composite

$$\begin{array}{ccccc} O & \twoheadrightarrow & A & \twoheadrightarrow & B \\ \parallel & \square & \downarrow & \square & \downarrow \\ O & \twoheadrightarrow & A' & \twoheadrightarrow & B' \end{array}$$

gives the square required for $B \twoheadrightarrow B'$ to be a weak equivalence.

Example 2.28. If \mathcal{C} is a Waldhausen category viewed as a squares category as in [Example 2.12](#), then $w^v\mathcal{C}$ are the weak equivalences in \mathcal{C} . To see this, note that a vertical morphism (i.e. any morphism $f: A \rightarrow B$ in \mathcal{C}) is a vertical weak equivalence precisely if the induced map out of the pushout $A \cong A \sqcup_O O \rightarrow B$ is a weak equivalence in \mathcal{C} , but this map is f itself.

Similarly, one can check that the maps in $w^h\mathcal{C}$ are the cofibrations $f: A \twoheadrightarrow B$ such that the unique map from the cofiber $B/A \rightarrow O$ is a weak equivalence. The Gluing lemma ensures that any trivial cofibration is in $w^h\mathcal{C}$. Conversely, if \mathcal{C} satisfies the extension axiom and is such that whenever $X \rightarrow 0$ is a weak equivalence, then $0 \rightarrow X$ is also a weak equivalence (which holds, for instance, if \mathcal{C} satisfies the saturation axiom), then any map in $w^h\mathcal{C}$ is a trivial cofibration.

Example 2.29. For FinSet as in [Example 2.13](#), the horizontal weak equivalences are bijections and the vertical weak equivalences are opposites of bijections.

¹Alternatively, one could construct a simplicial double category whose horizontal (resp. vertical) morphisms are the horizontal (resp. vertical) natural transformations; this is the approach taken in [\[SS21\]](#), but is more technically involved than what we require here.

Example 2.30. In the polytopes example [Example 2.14](#), the weak equivalences are given by the isometries in G : the horizontal equivalences are actual isometries and the vertical equivalences are opposites of isometries.

Example 2.31. Let $\widetilde{\text{Mfld}}_d^\partial$ be the squares category from [Example 2.15](#). Then the horizontal weak equivalences are diffeomorphisms (rel boundary) and vertical weak equivalences are the opposites of diffeomorphisms (rel boundary).

Example 2.32. In [Example 2.16](#), [Example 2.18](#), and [Example 2.19\(1\)](#), the weak equivalences are all identities.

Example 2.33. In the graphs examples [Example 2.19](#) (2) and (3), the weak equivalences are graph isomorphisms.

Remark 2.34. Note that if \mathcal{C} is a Waldhausen category viewed as a squares category, then our definition of $S_\bullet^\square \mathcal{C}$ does not quite match the simplicial category $wS_\bullet \mathcal{C}$ introduced by Waldhausen. The issue is with the objects, which in the classical setting consist of diagrams with pushout squares, but in the double categorical setting have pushouts *up to weak equivalence*. In [Corollary 2.54](#), we show that $S_\bullet^\square \mathcal{C}$ does give an alternate model for the K -theory of any Waldhausen category; hence, it agrees with Waldhausen’s construction after realization.

A feature of the S_\bullet^\square -construction is that a squares functor $\mathcal{C} \rightarrow \mathcal{D}$ between Waldhausen categories will induce a morphism of simplicial categories $S_\bullet^\square \mathcal{C} \rightarrow S_\bullet^\square \mathcal{D}$. Notably, the same statement does not hold for Waldhausen’s definition of S_\bullet . Indeed, although every exact functor of Waldhausen categories induces a squares functor on their associated squares categories ([Example 2.12](#)), it is not the case that every squares functor induces an exact functor, as it may not preserve pushouts along cofibrations in general. Instead, a squares functor $F: \mathcal{C} \rightarrow \mathcal{D}$ will only be “weakly exact” in the sense that there is a (canonical) weak equivalence $FB \cup_{FA} FC \xrightarrow{\sim} F(B \cup_A C)$ for any span $C \leftarrow A \rightarrow B$. Our definition of S_\bullet is functorial in weakly exact functors.

Note that there is no conflict in the “natural transformation” direction: by the gluing lemma, any commutative square of the form

$$\begin{array}{ccc} A & \twoheadrightarrow & B \\ \sim \downarrow & & \downarrow \sim \\ A' & \twoheadrightarrow & B' \end{array}$$

will be such that the induced map $A' \sqcup_A B \rightarrow B'$ is a weak equivalence and hence it is a square in the double category. Then, a natural transformation that is a pointwise weak equivalence encodes the same data as a vertical natural transformation valued in $w^v \mathcal{C}$.

Remark 2.35. Our definition of the S_\bullet^\square -construction is very similar to the S'_\bullet -construction of Blumberg–Mandell. In [\[BM08, Theorem 2.9\]](#), they show that the S'_\bullet -construction models the K -theory of a large class of Waldhausen categories. Although their construction is morally similar to ours (using homotopy pushouts rather than actual pushouts), we do not in general expect the two to be the same since the S'_\bullet -construction uses a more general notion of cofibration.

Example 2.36. In [\[OS24\]](#), Ogawa–Shah introduce the notion of a *weak Waldhausen category*, which is a generalization of a Waldhausen category that also includes triangulated categories as examples, and define their Grothendieck group. Every weak Waldhausen category \mathcal{C} defines a squares category, where the horizontal morphisms are the cofibrations, the vertical morphisms are all morphisms in \mathcal{C} , and the squares are the weak pushout squares of [\[OS24, Remark 2.14\(3\)\]](#). Morphisms of weak Waldhausen categories, defined in [\[OS24, Definition 2.18\]](#), are precisely the weakly exact functors described in [Remark 2.34](#). In particular, the S_\bullet^\square -construction is functorial in weak Waldhausen categories and weakly exact functors, and

produces a space $K(\mathcal{C}) := \Omega |S_{\bullet}^{\square} \mathcal{C}|$ so that $K_0(\mathcal{C})$ is precisely the Grothendieck group defined by Ogawa–Shah.

We conclude this subsection by showing that, just like in the classical setting, when the weak equivalences are isomorphisms our construction above does not introduce any additional data.

Proposition 2.37. *Let \mathcal{C} be a squares category such that $w^v \mathcal{C} = \text{iso}(\mathcal{V}_{\mathcal{C}})$. Then $|S_{\bullet}^{\square} \mathcal{C}| \simeq |\text{ob } S_{\bullet}^{\square} \mathcal{C}|$.*

Proof. This is the analogue of [Wal83, Corollary of Lemma 1.4.1]. Note that $N_0^w S_n^{\square} \mathcal{C} = \text{ob } S_n^{\square} \mathcal{C}$ and all of the face and degeneracy maps in $N_*^w S_n^{\square} \mathcal{C}$ are homotopy equivalences (since all the morphisms in N^w are isomorphisms). Hence $|S_{\bullet}^{\square} \mathcal{C}| \simeq |N_0^w S_{\bullet}^{\square} \mathcal{C}| \simeq |\text{ob } S_{\bullet}^{\square} \mathcal{C}|$. \square

2.3. Proto-Waldhausen categories. In this subsection, we describe sufficient conditions for the T_{\bullet} -construction and S_{\bullet}^{\square} -construction to coincide for a given squares category. Inspired by the proto-exact categories of [DK19], we introduce a notion of *proto-Waldhausen category*. Essentially, this will be a double categorical version of a Waldhausen category, where we enforce conditions on the squares so they behave like pushout squares.

Given a squares category \mathcal{C} and any (flat) double category \mathbb{I} , we can define a double category $\text{Fun}(\mathbb{I}, \mathcal{C})$ whose objects are the double functors, horizontal (resp. vertical) morphisms are the horizontal (resp. vertical) natural transformations of Definition 2.3, and where squares are defined pointwise. Moreover, $\text{Fun}(\mathbb{I}, \mathcal{C})$ inherits a squares category structure with pointwise basepoint. We will particularly care about the cases where \mathbb{I} is the flat double category generated by a single square, or a single “span”, or a single “cospan” as illustrated below

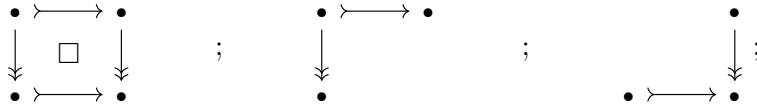

we denote these by $\mathbb{I}_1 = \begin{array}{ccc} \bullet & \xrightarrow{\quad} & \bullet \\ \downarrow & \square & \downarrow \\ \bullet & \xrightarrow{\quad} & \bullet \end{array}$, $\mathbb{I}_2 = \begin{array}{ccc} \bullet & \xrightarrow{\quad} & \bullet \\ \downarrow & & \downarrow \\ \bullet & & \bullet \end{array}$ and $\mathbb{I}_3 = \begin{array}{ccc} & & \bullet \\ & & \downarrow \\ \bullet & \xrightarrow{\quad} & \bullet \end{array}$, respectively.

Definition 2.38. A *proto-Waldhausen category* is a squares category \mathcal{C} satisfying the following conditions:

- (i) The functor $i^*: \text{Fun}^v(\begin{array}{ccc} \bullet & \xrightarrow{\quad} & \bullet \\ \downarrow & \square & \downarrow \\ \bullet & \xrightarrow{\quad} & \bullet \end{array}, \mathcal{C}) \rightarrow \text{Fun}^v(\begin{array}{ccc} \bullet & \xrightarrow{\quad} & \bullet \\ \downarrow & & \downarrow \\ \bullet & & \bullet \end{array}, \mathcal{C})$ induced by the inclusion $i: \begin{array}{ccc} \bullet & \xrightarrow{\quad} & \bullet \\ \downarrow & & \downarrow \\ \bullet & & \bullet \end{array} \hookrightarrow \begin{array}{ccc} \bullet & \xrightarrow{\quad} & \bullet \\ \downarrow & \square & \downarrow \\ \bullet & \xrightarrow{\quad} & \bullet \end{array}$ admits a section functor s .
- (ii) There is a natural transformation $w: si^* \Rightarrow \text{id}$ whose component on a square is

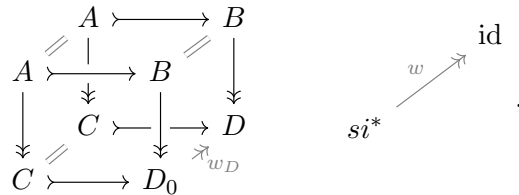

Recall that, by definition of morphism in $\text{Fun}^v(\begin{array}{ccc} \bullet & \xrightarrow{\quad} & \bullet \\ \downarrow & \square & \downarrow \\ \bullet & \xrightarrow{\quad} & \bullet \end{array}, \mathcal{C})$, all squares in the above diagram are of the appropriate type.

The definition above is meant to invoke the idea of squares being pushouts up to weak equivalence, as in the Thomason construction of a Waldhausen category. To make this more clear, and to elucidate the definitions, let us unpack explicitly the conditions in Definition 2.38.

Remark 2.39. Condition (i) states that for each diagram as below left with squares of the appropriate type

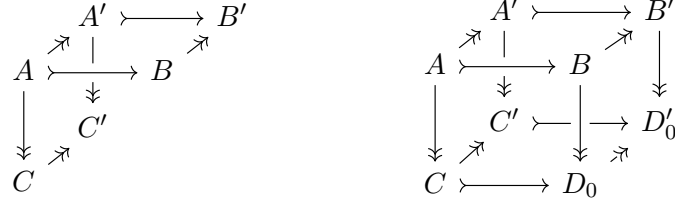

we can complete the front and back spans to distinguished squares, and there is an induced vertical map between the span completions such that all of the squares created in the diagram above right are of the appropriate type, and this is done functorially in the direction of the vertical natural transformation.

The requirement of condition (ii) on objects is depicted above in the definition. In particular, note that the induced vertical morphism $w_D: D_0 \rightarrow D$ is always a vertical weak equivalence, since we have a composite of the distinguished squares

$$\begin{array}{ccccc} O & \twoheadrightarrow & C & \twoheadrightarrow & D_0 \\ \parallel & \square & \parallel & \square & \downarrow w_D \\ O & \twoheadrightarrow & C & \twoheadrightarrow & D \end{array}$$

The naturality requirement in condition (ii) states that, for every diagram as below left with squares of the appropriate type

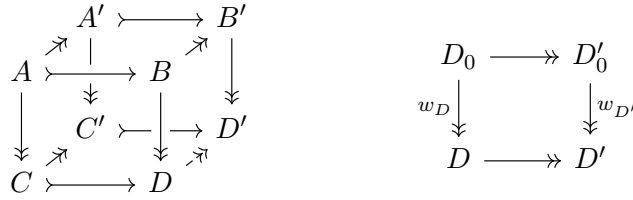

the resulting diagram depicted above right commutes in \mathcal{V}_C .

Example 2.40. If \mathcal{C} is a Waldhausen category, then the squares category defined from \mathcal{C} is proto-Waldhausen. To check condition (i), note that we can complete any span as below left

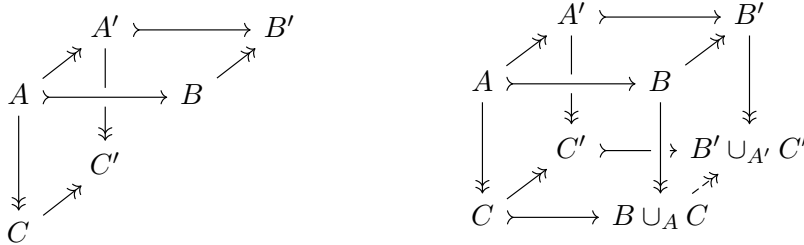

to a diagram as above right by taking pushouts. The required vertical map is given by the universal property of the pushout for $B \sqcup_A C$. By construction, the front and back faces of the cube are squares in the double category, and the right face in the cube is a commutative diagram. To see that the bottom face we obtain is a square in the double category, note that there is a weak equivalence

$$(B \cup_A C) \cup_C C' \cong B \cup_A C' \cong (B \cup_A A') \cup_{A'} C' \xrightarrow{\sim} B' \cup_{A'} C'$$

where the last map uses the gluing axiom and the weak equivalence $B \cup_A A' \xrightarrow{\sim} B'$ as the top face of the cube is a square in the double category. Functoriality of this section is guaranteed by the universal property of the pushout.

The natural transformation w_* of condition (ii) is constructed using the definition of the squares in the squares category obtained from \mathcal{C} . Finally, the naturality of w_* is a direct consequence of the universal property of the pushout.

Example 2.41. The weak Waldhausen categories of [Example 2.36](#) are not proto-Waldhausen, although they are very close. In particular, even if one could define s on objects, this section is only guaranteed to be defined on those morphisms in $\text{Fun}^v(\overline{\square}, \mathcal{C})$ which are pointwise weak equivalences (using [\[OS24, Definition 2.13\(WW1\)\]](#)). We emphasize that this entire structure is needed for the comparison S_{\bullet}^{\square} -construction and T_{\bullet} -construction. However, it is possible that certain examples weak Waldhausen categories may admit a proto-Waldhausen structure.

Example 2.42. The finite sets example [Example 2.13](#) is proto-Waldhausen since every span can be completed

$$\begin{array}{ccc} A \hookrightarrow B & & A \hookrightarrow B \\ \downarrow & \rightsquigarrow & \downarrow \quad \square \quad \downarrow \\ C & & C \hookrightarrow C \cup B \setminus A \end{array}$$

and $C \cup B \setminus A$ is uniquely determined up to isomorphism. Note that these squares are stable: a commutative square of finite sets and injections is a pushout if and only if it is also a pullback.

Example 2.43. The polytope example from [Example 2.14](#) is proto-Waldhausen, again essentially because we can take complements. For instance, we have

which is a square in \mathbb{P}_G^2 (we do not require polytopes to be convex). In general (suppressing the data of the specified isometries in the morphisms), a span $P \leftarrow Q \rightarrow R$ corresponds to a sequence $P \rightarrow Q \rightarrow R$ and may be completed to a square via $P \rightarrow P \cup (\overline{Q \setminus R}) \rightarrow R$; here we are using the fact that the complement of a polytope inclusion is again a polytope and the union of two polytopes is a polytope. Any other polytope Q' that completes the span is necessarily isometric to $P \cup (\overline{Q \setminus R})$ (since the inclusion $Q' \rightarrow R$ is an isometry onto its image).

Example 2.44. The category with squares $\widetilde{\text{Mfld}}_d^\partial$ from [Example 2.15](#) is not proto-Waldhausen because not every span of morphisms can be completed to a square. Recall that

$$\begin{array}{ccc} N \hookrightarrow M & & N \hookrightarrow M \\ \downarrow & \rightsquigarrow & \uparrow \\ M' & & M' \end{array} \quad \text{in } \widetilde{\text{Mfld}}_d^\partial$$

where \hookrightarrow denotes the SK -embeddings from [\[Hoe+22, Definition 4.1\]](#). In particular, taking $M' = \emptyset$, completing the span above to a square is like asking for $\overline{N \hookrightarrow M}$ to have a complement. Although the conditions on SK -embeddings ensure that $\overline{M \setminus N}$ is an object of

Mfld_d^∂ , the commuting square

$$\begin{array}{ccc} N & \hookrightarrow & M \\ \uparrow & & \uparrow \\ \emptyset & \hookrightarrow & \overline{M \setminus N} \end{array}$$

is not a pushout in Mfld_d^∂ .

There are two potential approaches one could take in order to solve this shortcoming. One option is to give an S_\bullet -construction for Mfld_d^∂ following [Remark 2.22](#), with the augmentation \mathcal{A} given by cylinders $N \times I$ for N a closed, orientable $(d - 1)$ -manifold. One could define a notion of augmented proto-Waldhausen category and make analogous arguments, although we do not pursue these ideas in this paper. Another option is to adjust the definition of Mfld_d^∂ so that the commutative squares above are distinguished. One could define a notion of SK -equivalence and then ask for squares to be “pushouts up to SK -equivalences,” much like the Thomason construction. We intend to further explore this idea, together with its resulting K -theory, in future work.

Example 2.45. The examples from [\[Ber+18\]](#) ([Example 2.16](#), [Example 2.18](#), [Example 2.19\(1\)](#)) are all proto-Waldhausen because they are all pointed stable double categories (which is a strictly stronger notion; see [Proposition 3.11](#)).

Example 2.46. For option (2) of [Example 2.19](#), the span completion s takes

$$\begin{array}{ccc} H \twoheadrightarrow G & & H \twoheadrightarrow G \\ \downarrow & \rightsquigarrow & \downarrow \quad \downarrow \\ H' & & H' \twoheadrightarrow G' \end{array}$$

where G' is the full subgraph of G on $V(H') \cup V(G) \setminus V(H)$; the components of the natural transformation w are graph inclusions which are identity on objects.

Example (3) is *not* proto-Waldhausen since not every span can be completed. For instance, for the specific example in [Example 2.19\(1\)](#), there is no way to complete the span to a square which is a pushout in the category of graphs.

2.4. A Waldhausen–Thomason comparison. In this section, we show that the constructions $T_\bullet \mathbb{C}$ and $S_\bullet^\square \mathbb{C}$ agree after realization whenever \mathbb{C} is proto-Waldhausen, following Waldhausen’s strategy (see [\[Wal83, §1.3\]](#)). These simplicial categories are not directly connected through a simplicial map. Instead, the key is to construct a third simplicial category $T_\bullet^+ \mathbb{C}$ together with simplicial maps

$$T_\bullet \mathbb{C} \leftarrow T_\bullet^+ \mathbb{C} \rightarrow S_\bullet^\square \mathbb{C}$$

which induce homotopy equivalences after realization.

We start by introducing the auxiliary simplicial category $T_\bullet^+ \mathbb{C}$. Intuitively, its role is to extend the objects of $T_\bullet \mathbb{C}$ to include choices of “cofibers”. In the classical setting of Waldhausen categories, these are constructed as actual cofibers by taking sequential pushouts. In our setting, the role played by pushouts squares is replaced by the squares in the squares category.

Definition 2.47. Given a squares category \mathbb{C} , let $T_n^+\mathbb{C}$ denote the category whose objects are pastings of the form

$$(2.48) \quad \begin{array}{ccccccc} C_0 & \xrightarrow{\quad} & C_1 & \xrightarrow{\quad} & C_2 & \xrightarrow{\quad} & \cdots & \xrightarrow{\quad} & C_n \\ \downarrow & \square & \downarrow & \square & \downarrow & \square & & \square & \downarrow \\ O & \xrightarrow{\quad} & C_{01} & \xrightarrow{\quad} & C_{02} & \xrightarrow{\quad} & \cdots & \xrightarrow{\quad} & C_{0n} \\ & & \downarrow & \square & \downarrow & \square & & \square & \downarrow \\ & & O & \xrightarrow{\quad} & C_{12} & \xrightarrow{\quad} & \cdots & \xrightarrow{\quad} & C_{1n} \\ & & & & & & & & \downarrow \\ & & & & & & & & \downarrow \\ & & & & & & \ddots & & \vdots \\ & & & & & & & & \downarrow \\ & & & & & & & & O \end{array}$$

and whose morphisms are vertical natural transformations between these diagrams; that is, pointwise vertical maps such that any square that is formed with two horizontal and two vertical boundaries is a square in \mathbb{C} , and any square with four vertical boundaries is a commutative square in the underlying vertical category $\mathcal{V}_{\mathbb{C}}$.

One can check that these assemble into a simplicial category $T_{\bullet}^+\mathbb{C}$, where the face map d_i removes the i th row and column (and composes when appropriate) and degeneracy maps simply insert identity maps and identity squares.

Proposition 2.49. *If \mathbb{C} is proto-Waldhausen, then the forgetful map $U: T_{\bullet}^+\mathbb{C} \rightarrow T_{\bullet}\mathbb{C}$ is a map of simplicial categories which is a homotopy equivalence after realization.*

Proof. For each n , the map U_n takes an object in $T_n^+\mathbb{C}$ (that is, a diagram as in 2.48) to its top row. This is clearly functorial, and it is straightforward to verify that it assembles into a map of simplicial categories.

We now define a section functor $F_n: T_n\mathbb{C} \rightarrow T_n^+\mathbb{C}$ for each n . This assignment takes an object

$$C_0 \twoheadrightarrow C_1 \twoheadrightarrow \cdots \twoheadrightarrow C_n$$

in $T_n\mathbb{C}$ to the diagram

$$\begin{array}{ccccccc} C_0 & \xrightarrow{\quad} & C_1 & \xrightarrow{\quad} & \cdots & \xrightarrow{\quad} & C_n \\ \downarrow & \square & \downarrow & \square & & \square & \downarrow \\ O & \xrightarrow{\quad} & D_{01} & \xrightarrow{\quad} & \cdots & \xrightarrow{\quad} & D_{0n} \\ & & \downarrow & \square & & \square & \downarrow \\ & & O & \xrightarrow{\quad} & \cdots & \xrightarrow{\quad} & D_{1n} \\ & & & & & & \downarrow \\ & & & & & & \downarrow \\ & & & & & & \vdots \\ & & & & & & \downarrow \\ & & & & & & O \end{array}$$

The rest of the data here is constructed using condition (i) of [Definition 2.38](#)² to complete the spans sequentially as follows:

$$\begin{array}{cccc}
 C_0 \twoheadrightarrow C_1 & C_i \twoheadrightarrow C_{i+1} & D_{i,i+1} \twoheadrightarrow D_{i,i+2} & D_{i,j} \twoheadrightarrow D_{i,j+1} \\
 \downarrow \lrcorner \square \downarrow & \downarrow \lrcorner \square \downarrow & \downarrow \lrcorner \square \downarrow & \downarrow \lrcorner \square \downarrow \\
 O \dashrightarrow D_{01} & D_{0i} \dashrightarrow D_{0i+1} & O \dashrightarrow D_{i+1,i+2} & D_{i+1,j} \dashrightarrow D_{i+1,j+1}
 \end{array}$$

A morphism of sequences in $T_n\mathbb{C}$ induces a morphism in $T_n^+\mathbb{C}$ between these span completions, and this is functorial as a consequence of the functoriality of the span completions from condition (i).

Clearly $U_n F_n = \text{id}$. To conclude our result, it suffices to construct a natural transformation $\tau: F_n U_n \Rightarrow \text{id}$ for each n , as this natural transformation will realize to a homotopy. Given an object $C \in T_n^+\mathbb{C}$ as in diagram (2.48), we need to construct the data of a vertical natural transformation

$$\begin{array}{ccccccccccc}
 & & C_0 & \twoheadrightarrow & C_1 & \twoheadrightarrow & \dots & \twoheadrightarrow & C_n & & \\
 & & \parallel & & \downarrow & \parallel & & & \parallel & & \\
 C_0 & \twoheadrightarrow & C_1 & \twoheadrightarrow & \dots & \twoheadrightarrow & C_n & & & & \\
 \downarrow & & \downarrow & & \downarrow & & \downarrow & & \downarrow & & \\
 O & \twoheadrightarrow & O & \twoheadrightarrow & C_{01} & \twoheadrightarrow & \dots & \twoheadrightarrow & C_{0n} & & \\
 \downarrow & & \downarrow & & \downarrow & & \downarrow & & \downarrow & & \\
 O & \twoheadrightarrow & D_{01} & \twoheadrightarrow & \dots & \twoheadrightarrow & D_{0n} & & & & \\
 \downarrow & & \downarrow & & \downarrow & & \downarrow & & \downarrow & & \\
 O & \twoheadrightarrow & O & \twoheadrightarrow & \dots & \twoheadrightarrow & C_{1n} & & & & \\
 \downarrow & & \downarrow & & \downarrow & & \downarrow & & \downarrow & & \\
 & & O & \twoheadrightarrow & \dots & \twoheadrightarrow & D_{1n} & & & & \\
 & & \parallel & & \downarrow & & \downarrow & & \downarrow & & \\
 & & O & \twoheadrightarrow & & & & & O & & \\
 & & & & \downarrow & & \downarrow & & \downarrow & & \\
 & & & & O & & O & & O & & \\
 & & & & \downarrow & & \downarrow & & \downarrow & & \\
 & & & & O & & O & & O & & \\
 & & & & \downarrow & & \downarrow & & \downarrow & & \\
 & & & & O & & O & & O & & \\
 & & & & \parallel & & \parallel & & \parallel & & \\
 & & & & O & & O & & O & & \\
 & & & & \downarrow & & \downarrow & & \downarrow & & \\
 & & & & O & & O & & O & & \\
 & & & & \parallel & & \parallel & & \parallel & & \\
 & & & & O & & O & & O & & \\
 & & & & \downarrow & & \downarrow & & \downarrow & & \\
 & & & & O & & O & & O & & \\
 & & & & \parallel & & \parallel & & \parallel & & \\
 & & & & O & & O & & O & &
 \end{array}$$

$$F_n U_n(C) \xrightarrow{\tau_C} C$$

We define the required vertical maps inductively, starting left to right in the top row and then moving on to the next. To illustrate an arbitrary step, suppose that we have constructed the data

$$(2.50) \quad \begin{array}{ccc}
 & C_{i,j} & \twoheadrightarrow & C_{i,j+1} \\
 D_{i,j} & \twoheadrightarrow & D_{i,j+1} & \\
 \downarrow & & \downarrow & \\
 & C_{i+1,j} & \twoheadrightarrow & C_{i+1,j+1} \\
 D_{i+1,j} & \twoheadrightarrow & D_{i+1,j+1} &
 \end{array}$$

where all squares are of the appropriate type. We first use condition (i) of [Definition 2.38](#) to complete the span on the back face to an object $X \in \mathbb{C}$. Since the diagram 2.50 contains the data of a map of spans, we get an induced diagram as below left where all squares are of the

²In the definition, the existence of a section s is a property rather than additional data, so a priori there could be several choices of s to complete the spans; however, this choice is irrelevant for our purposes.

appropriate type.

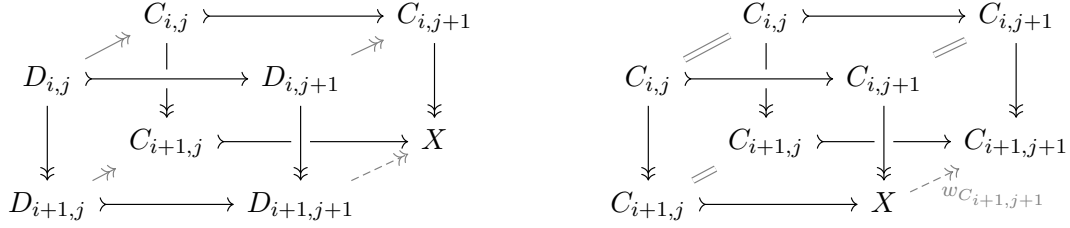

Next, we use the data on objects of condition (ii) of [Definition 2.38](#) to get a diagram as above right, where again, all squares are of the appropriate type. The composite of these two diagrams in the vertical (gray) direction yields the required vertical map

$$D_{i+1,j+1} \twoheadrightarrow X \twoheadrightarrow C_{i+1,j+1}$$

as well as the required squares.

For the naturality of τ , we must check that for every vertical natural transformation $X \rightarrow X'$ in $T_n^+\mathbb{C}$, the resulting diagram

$$\begin{array}{ccc} D_{ij} & \twoheadrightarrow & D'_{ij} \\ w_{C_{ij}} \downarrow & & \downarrow w_{C'_{ij}} \\ C_{ij} & \twoheadrightarrow & C'_{ij} \end{array}$$

commutes in $\mathcal{V}_{\mathbb{C}}$. This is precisely the naturality of w_* given by condition (ii) of [Definition 2.38](#). \square

Remark 2.51. Note that the sections F_n constructed above do not necessarily assemble into a map of simplicial categories. Indeed, if we examine the action of the inner faces, having a simplicial map would require that the composite of two span completions as below left

$$\begin{array}{ccccc} A & \twoheadrightarrow & B & \twoheadrightarrow & C \\ \downarrow & \square & \downarrow & \square & \downarrow \\ A' & \dashrightarrow & B' & \dashrightarrow & C' \end{array} \qquad \begin{array}{ccccc} A & \twoheadrightarrow & B & \twoheadrightarrow & C \\ \downarrow & & \downarrow & & \downarrow \\ A' & \dashrightarrow & & \dashrightarrow & D \end{array}$$

agree with the span completion of the composite horizontal maps as above right. However, we do not expect this condition to hold in most examples of interest; for instance, when span completions are obtained from pushouts, the objects C' and D above will only agree *up to isomorphism*.

We now construct the homotopy equivalence between $T_{\bullet}^+\mathbb{C}$ and $S_{\bullet}^{\square}\mathbb{C}$.

Proposition 2.52. *For any squares category \mathbb{C} , the forgetful map $U: T_{\bullet}^+\mathbb{C} \rightarrow S_{\bullet}^{\square}\mathbb{C}$ is a map of simplicial categories which is a homotopy equivalence after realization.*

Proof. For each n , the map U_n takes an object in $T_n^+\mathbb{C}$ (that is, a diagram as in [Equation \(2.48\)](#)) to the subdiagram obtained by deleting its top row, which is an object in $S_{\bullet}^{\square}\mathbb{C}$. This is clearly functorial, and it is straightforward to verify that it assembles into a map of simplicial categories.

We now define a section functor $F_n: S_n^\square \mathbb{C} \rightarrow T_n^+ \mathbb{C}$ for each n . This assignment takes an object in $S_n \mathbb{C}$ as depicted below left to the object of $T_n^+ \mathbb{C}$ depicted below right.

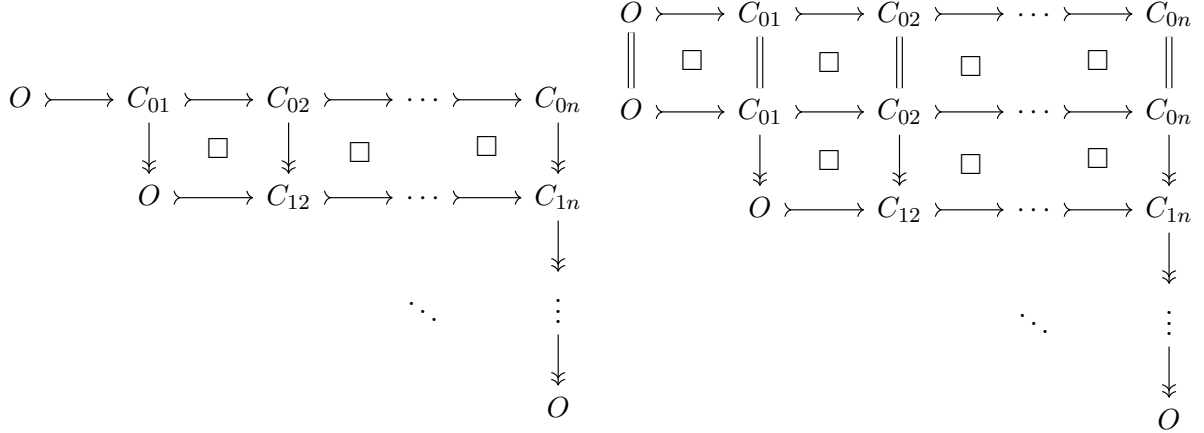

Clearly F_n is a functor, defined on maps in the evident way. Note that these functors do not assemble into a simplicial map, as they do not commute with d_0 . Moreover, we have $U_n F_n = \text{id}$; we conclude our proof by constructing a natural transformation $\tau: \text{id} \Rightarrow F_n U_n$.

For each object $X \in T_n^+ \mathbb{C}$, the component τ_X is the vertical natural transformation

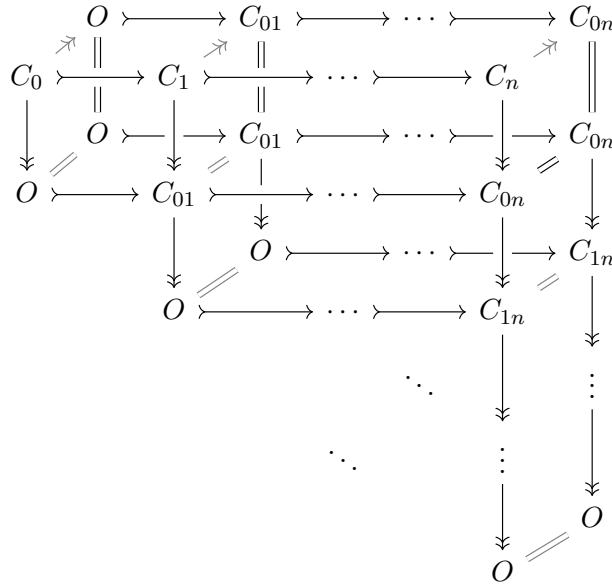

It is straightforward to verify that τ is natural. □

As an immediate corollary, we have the following result.

Theorem 2.53. *If \mathbb{C} is a proto-Waldhausen category, there is an equivalence of spaces $|T_\bullet \mathbb{C}| \xrightarrow{\cong} |S_\bullet^\square \mathbb{C}|$.*

In particular we deduce that for any Waldhausen category the K -theory space produced by our S_\bullet^\square -construction, whose staircase diagrams involve pushouts up to weak equivalence, recovers the correct space up to homotopy.

Corollary 2.54. *The S_\bullet^\square -construction of Definition 2.20 gives another model for the K -theory of a Waldhausen category.*

Proof. This is a consequence of Example 2.40 and Theorem 2.53. □

3. CONNECTION WITH 2-SEGAL OBJECTS

A 2-Segal set is a simplicial set X which behaves like a “multi-valued category” in the sense that it has objects X_0 and morphisms X_1 , but no well-defined notion of composition; in particular, the first map in the span

$$X_1 \times_{X_0} X_1 \leftarrow X_2 \rightarrow X_1$$

need not be a bijection. However, there is a well-defined “composition” of 2-simplices (whence the “2” in 2-Segal) in the sense that the first map in the span

$$X_2 \times_{X_1} X_2 \leftarrow X_3 \rightarrow X_2$$

is invertible. Moreover, this composition is associative, as witnessed by the fact that the 2-Segal maps

$$X_n \xrightarrow{\cong} X_2 \times_{X_1} \cdots \times_{X_1} X_2$$

which land in the $(n - 1)$ -fold iterated pullback are isomorphisms for $n \geq 3$. More generally, one has the notion of 2-Segal spaces which are simplicial spaces so that the 2-Segal maps above are weak equivalences.

Since their introduction by Dyckerhoff–Kapronov in [DK19] and independently by Gálvez–Carriollo–Kock–Tonks in [GKT18], 2-Segal spaces have been connected to a variety of different areas of study, including the theory of Hall algebras [Dyc18; Pen17; Wal17; You18], enumerative combinatorics [Car20; CK20; GKT18], higher category theory [Fel23; Ste19], and higher algebraic K -theory [Ber+18; Car24; Pog17]. In [DK19] and [GKT18], both teams of authors observed a particularly striking connection between 2-Segal sets and higher algebraic K -theory; namely, that Waldhausen’s S_\bullet -construction outputs 2-Segal objects when fed categorical inputs with enough structure.

In [Ber+18], Bergner–Osorno–Ozornova–Rovelli–Scheimbauer take this idea a step further and identify the precise categorical structure necessary for a version of the S_\bullet -construction to produce a 2-Segal set. The structures they consider, called *stable augmented double categories*, are double categories which (among other conditions) satisfy a “stability” condition: every span and cospan can be uniquely completed to a square

$$\begin{array}{ccc} A \rightrightarrows B & & B \\ \downarrow & \rightsquigarrow & \downarrow \\ C & & C \rightrightarrows D \end{array} \quad \text{and} \quad \begin{array}{ccc} & & B \\ & & \downarrow \\ C \rightrightarrows D & \rightsquigarrow & \downarrow \\ & & C \rightrightarrows D \end{array}.$$

The S_\bullet -construction of such a double category consists of diagrams of the form

$$\begin{array}{ccccccc} A_{00} & \rightrightarrows & A_{01} & \rightrightarrows & A_{02} & \rightrightarrows & \cdots & \rightrightarrows & A_{0n} \\ & & \downarrow & \square & \downarrow & \square & & \square & \downarrow \\ & & A_{11} & \rightrightarrows & A_{12} & \rightrightarrows & \cdots & \rightrightarrows & A_{1n} \\ & & & & & & \ddots & & \downarrow \\ & & & & & & & & A_{nn} \end{array}$$

where each A_{ii} is in the *augmentation* of the double category. The main result of [Ber+18] is that their S_\bullet -construction gives an equivalence of categories between stable augmented double categories and 2-Segal sets; the inverse is very explicit and uses a path space construction (see [Ber+18, Section 5]). Hence the S_\bullet -construction of a stable augmented double category is completely characterized by having a 2-Segal structure.

Inspired by this result, one could ask when the K -theory of a category with squares determines a 2-Segal object. In this section, we introduce *stable squares categories* (Definition 3.9), which are like the stable (pointed) double categories above but with weak equivalences. Because of these weak equivalences, stable squares categories do not always produce 2-Segal objects. However, when the weak equivalences are invertible (along with one additional, mild condition, see Definition 3.20), the S_{\bullet}^{\square} -construction of a stable squares category is a 2-Segal space (Theorem 3.30). Examples that satisfy these conditions include finite sets (Example 2.13), polytopes (Example 2.14), and the Waldhausen category of finitely-generated projective R -modules.

Remark 3.1. In [Ber+21], Bergner–Osorno–Ozornova–Rovelli–Scheimbauer broaden the scope of their results to include more homotopical contexts, using a sufficiently nice model category \mathcal{A} . Their main result is that a kind of S_{\bullet} -construction induces a Quillen equivalence between the category of (unital) 2-Segal objects and a category of *augmented stable double Segal objects* in \mathcal{A} . These augmented stable double Segal objects can be interpreted as the internal double nerve of a double \mathcal{A} -category (a category internal to categories internal to \mathcal{A}), and one could ask about connections to categories with squares and a T_{\bullet} -construction in this context. This would require developing a theory of internal squares categories, which we do not pursue in this paper (but is considered for spaces in [HRS22]).

3.1. 2-Segal objects. There are many equivalent ways to formulate what it means to be a 2-Segal object, one of which is the following.

Definition 3.2. A 2-Segal object in a category \mathcal{A} is a functor $X: \Delta^{\text{op}} \rightarrow \mathcal{A}$ so that for every $n \geq 3$, and any $0 \leq i < j \leq n$, the diagram

$$\begin{array}{ccc} \{0, \dots, n\} & \longleftarrow & \{i, \dots, j\} \\ \uparrow & & \uparrow \\ \{0, \dots, i, j, \dots, n\} & \longleftarrow & \{i, j\} \end{array}$$

in Δ is sent to a homotopy pullback

$$\begin{array}{ccc} X_n & \longrightarrow & X_{\{i, \dots, j\}} \\ \downarrow & & \downarrow \\ X_{\{0, \dots, i, j, \dots, n\}} & \longrightarrow & X_{\{i, j\}} \end{array}$$

in \mathcal{A} . We let $2\text{Seg}_{\mathcal{A}}$ denote the category of 2-Segal objects in \mathcal{A} and maps between them (i.e. natural transformations), only using the subscript \mathcal{A} when the ambient category is not clear from context.

Remark 3.3. As shown in [Ber+21, Proposition 1.17], for each $n \geq 3$, it suffices to consider the diagrams for $(i, j) = (0, 2)$ and $(i, j) = (n - 2, n)$.

In the literature, many authors impose the additional condition that their 2-Segal objects are *unital*, meaning that the squares

$$\begin{array}{ccc} X_1 & \xrightarrow{d_0} & X_0 \\ s_1 \downarrow & & \downarrow s_0 \\ X_2 & \xrightarrow{d_0} & X_1 \end{array} \quad \text{and} \quad \begin{array}{ccc} X_1 & \xrightarrow{d_1} & X_0 \\ s_0 \downarrow & & \downarrow s_0 \\ X_2 & \xrightarrow{d_2} & X_1 \end{array}$$

are pullbacks (c.f. [Ber+18, Lemma 1.11]). However, [Fel+21] has since shown that every 2-Segal space is equivalent to a unital one, and so we will not make such a restriction.

Definition 3.4. A 2-Segal object is *reduced* if $X(0) = *$. We let $2\text{Seg}_* \subseteq 2\text{Seg}$ denote the subcategory of reduced 2-Segal objects.

One well-studied example of 2-Segal objects comes from Waldhausen’s S_\bullet -construction on an exact category. As discussed in [DK19, Remark 7.3.7], it is known that $S_\bullet(\mathcal{C})$ may not be 2-Segal for an arbitrary Waldhausen category \mathcal{C} (see also [Car24]). However, in [Ber+18], Bergner–Osorno–Ozornova–Rovelli–Scheimbauer show that every 2-Segal set arises as the S_\bullet -construction of a certain kind of double category, called *stable augmented double categories*. For simplicity, we will restrict from augmented to pointed double categories (corresponding to reduced 2-Segal sets), although one could similarly study the augmented case (c.f. Remark 2.22).

Definition 3.5. A double category \mathbb{C} is *stable* if every square is uniquely determined by its span and cospan, meaning there are bijections

$$\mathcal{H}_{\mathbb{C}} \times_{\text{ob } \mathbb{C}} \mathcal{V}_{\mathbb{C}} \leftarrow \text{Sq}(\mathbb{C}) \rightarrow \mathcal{V}_{\mathbb{C}} \times_{\text{ob } \mathbb{C}} \mathcal{H}_{\mathbb{C}}$$

given by the maps

$$\begin{array}{ccccc} \bullet & & \bullet & \xrightarrow{\quad} & \bullet \\ & \downarrow & \downarrow & & \downarrow \\ \bullet & \xrightarrow{\quad} & \bullet & & \bullet \end{array} \quad \begin{array}{c} \leftarrow \\ \rightarrow \end{array} \quad \begin{array}{ccccc} \bullet & & \bullet & \xrightarrow{\quad} & \bullet \\ & \downarrow & \downarrow & & \downarrow \\ \bullet & \xrightarrow{\quad} & \bullet & & \bullet \end{array} \quad \begin{array}{c} \leftarrow \\ \rightarrow \end{array} \quad \begin{array}{ccccc} \bullet & & \bullet & \xrightarrow{\quad} & \bullet \\ & \downarrow & \downarrow & & \downarrow \\ \bullet & \xrightarrow{\quad} & \bullet & & \bullet \end{array} .$$

Proposition 3.6. *If \mathbb{C} is a pointed stable double category, then the simplicial set of objects $\text{ob } S_\bullet^\square \mathbb{C}$ agrees with the S_\bullet -construction of [Ber+18].*

Proof. A stable double category \mathbb{C} is, by definition, a flat double category. Then, a stable pointed double category is an example of a squares category, and we can consider its K -theory construction $K^\square(\mathbb{C})$. It is straightforward to check that the definition of S_\bullet given in [Ber+18, Section 4.7] is the simplicial set of objects of the simplicial category described by Definition 2.20. \square

We can use this observation and the results from [Ber+18] to immediately deduce the following.

Corollary 3.7. *Every reduced 2-Segal set is equivalent to $\text{ob } S_\bullet^\square \mathbb{C}$ for some squares category \mathbb{C} .*

Remark 3.8. Note that stability of \mathbb{C} implies that the maps in $w^h \mathbb{C}$ and $w^v \mathbb{C}$ must be *equalities* (not even just isomorphisms). In particular, the same argument from Proposition 2.37 implies that $|S_\bullet^\square \mathbb{C}| \simeq |\text{ob } S_\bullet^\square \mathbb{C}|$; hence the K^\square -theory space as a squares category and the space obtained from the S_\bullet -construction of [Ber+18] agree by Theorem 2.53.

3.2. Stable squares categories. We now introduce a notion of “stability” for squares categories, that will allow us to connect these structures to 2-Segal objects via the S_\bullet^\square -construction of Subsection 2.2. Essentially, a stable squares category satisfies both the proto-Waldhausen conditions and their duals.

Definition 3.9. A squares category \mathbb{C} is *stable* if

- (i) The functor $i^* : \text{Fun}^v(\mathbb{I}^\square, \mathbb{C}) \rightarrow \text{Fun}^v(\mathbb{I}^\square, \mathbb{C})$ induced by the inclusion $i : \mathbb{I}^\square \hookrightarrow \mathbb{I}^\square$ admits a section functor s .
- (ii) There is a natural transformation $w : si^* \Rightarrow \text{id}$ whose component on a square is

$$\begin{array}{ccc} \begin{array}{ccc} A & \xrightarrow{\quad} & B \\ \parallel \downarrow & & \parallel \downarrow \\ A & \xrightarrow{\quad} & B \\ \downarrow & & \downarrow \\ C & \xrightarrow{\quad} & D \\ \parallel \downarrow & & \parallel \downarrow \\ C & \xrightarrow{\quad} & D_0 \end{array} & \xrightarrow{w} & \text{id} \\ si^* & & \end{array} .$$

- (iii) The functor $j^* : \text{Fun}^v(\mathbb{I}^\square, \mathbb{C}) \rightarrow \text{Fun}^v(\mathbb{I}^\square, \mathbb{C})$ induced by the inclusion $j : \mathbb{I}^\square \hookrightarrow \mathbb{I}^\square$ admits a section functor t .

(iv) There is a natural transformation $u: tj^* \Rightarrow \text{id}$ whose component on a square is

$$\begin{array}{ccc}
 & A \xrightarrow{\quad} B & \\
 u_A \nearrow & \downarrow & \Downarrow \\
 A_0 \xrightarrow{\quad} B & \Downarrow & \\
 \downarrow & C \xrightarrow{\quad} D & \\
 \Downarrow & \Downarrow & \\
 C \xrightarrow{\quad} D & & \\
 & & \text{id} \\
 & & \nearrow u \\
 tj^* & &
 \end{array}$$

and such that the map u_A is a weak equivalence for all A .

Remark 3.10. The first two conditions in the above definition just say that \mathbb{C} is proto-Waldhausen. Conditions (iii) and (iv) are analogous to (i) and (ii) but for cospans instead of spans, the only notable difference being that we need the separate requirement that the natural transformation is point-wise a weak equivalence, as this is no longer implied by the rest of the data. Dually to the proto-Waldhausen axioms, conditions (iii) and (iv) invoke the idea that distinguished squares are pullbacks up to weak equivalence. In Remark 3.27, we explain our choice of “dualization” that only includes vertical natural transformations, and mention other plausible notions of stability.

Our first example of stable squares category shows how they provide a generalization of the pointed stable double categories of [Ber+18].

Proposition 3.11. *Every pointed stable double category is a stable squares category.*

Proof. As explained in Proposition 3.6, a pointed stable double category is a squares category in which the weak equivalences $w^h\mathbb{C}$ and $w^v\mathbb{C}$ are just the identity morphisms. For the stability conditions, recall that every span and cospan completes uniquely to a square; this defines the functors s and t on objects. To define the functor s on morphisms, suppose we have a diagram as below left

$$\begin{array}{ccc}
 & A' \xrightarrow{\quad} B' & \\
 A \nearrow & \downarrow & \Downarrow \\
 A \xrightarrow{\quad} B & \Downarrow & \\
 \downarrow & C' \xrightarrow{\quad} D' & \\
 \Downarrow & \Downarrow & \\
 C \xrightarrow{\quad} D & & \\
 & & C \xrightarrow{\quad} D \\
 & & \downarrow \square \downarrow \\
 & & C' \xrightarrow{\quad} E
 \end{array}$$

where all squares are of the appropriate kind. Completing the span

$$C' \leftarrow C \rightarrow D$$

yields a square as depicted above right. We now have two squares given by the vertical composites

$$\begin{array}{ccc}
 A \xrightarrow{\quad} B & & A \xrightarrow{\quad} B \\
 \downarrow \square \downarrow & & \downarrow \square \downarrow \\
 A' \xrightarrow{\quad} B' & & C \xrightarrow{\quad} D \\
 \downarrow \square \downarrow & & \downarrow \square \downarrow \\
 C' \xrightarrow{\quad} D' & & C' \xrightarrow{\quad} E
 \end{array}$$

both of which complete the same span

$$C' \leftarrow A \rightarrow B.$$

By assumption, these must agree; then our required map $D \rightarrow D'$ is the map $D \rightarrow E$ and the two new squares created in the cube are of the appropriate type.

Since s was constructed using the unique span completions, it must be functorial. One defines the functor t analogously, using the unique cospan completions. Finally, the required natural transformations w and u are simply the identity. \square

Example 3.12. By [Ber+18], every pointed 2-Segal set X determines a pointed stable double category, and hence a stable squares category. In the case that $X = S_\bullet \mathbb{C}$ is the S_\bullet -construction of [Ber+18] on a pointed stable double category \mathbb{C} , we detail the structure of the corresponding category of squares \mathbb{X} . The objects of \mathbb{X} are $* \rhd c \in S_1 \mathbb{C}$; horizontal morphisms $(* \rightarrow c_0) \rhd (* \rightarrow c_1)$ and vertical morphisms $(* \rightarrow d_0) \rhd (* \rightarrow d_1)$ are elements of $S_2 \mathbb{C}$ of the form

$$\begin{array}{ccc} * \rhd & \longrightarrow & c_0 \rhd & \longrightarrow & c_1 \\ & & \downarrow & \square & \downarrow \\ & & * \rhd & \longrightarrow & c_{01} \\ & & \downarrow & & \downarrow \\ & & * & & * \end{array} \quad \text{and} \quad \begin{array}{ccc} * \rhd & \longrightarrow & c_0 \rhd & \longrightarrow & d_0 \\ & & \downarrow & \square & \downarrow \\ & & * \rhd & \longrightarrow & d_1 \\ & & \downarrow & & \downarrow \\ & & * & & * \end{array},$$

respectively. A distinguished square in \mathbb{X} is an element of $S_3 \mathbb{C}$,

$$\begin{array}{ccc} (* \rightarrow c_0) \rhd & \longrightarrow & (* \rightarrow c_1) \\ \downarrow & \square & \downarrow \\ (* \rightarrow d_0) \rhd & \longrightarrow & (* \rightarrow d_1) \end{array} = \begin{array}{ccccc} * \rhd & \longrightarrow & c & \longrightarrow & c_0 \rhd & \longrightarrow & c_1 \\ \downarrow & \square & \downarrow & \square & \downarrow & & \downarrow \\ * \rhd & \longrightarrow & d_0 & \longrightarrow & d_1 \\ \downarrow & & \downarrow & \square & \downarrow \\ * \rhd & \longrightarrow & d & \longrightarrow & * \\ & & \downarrow & & \downarrow \\ & & * & & * \end{array}$$

and the distinguished object is the identity on $*$.

The notion of a stable squares category is inspired by that of proto-exact categories from [DK19, §2.4], a generalization of exact categories. Examples of proto-exact categories include the category of finite pointed sets and the category of finitely generated projective R -modules.

Definition 3.13. A *proto-exact category* is a pointed category \mathcal{C} with two distinguished classes of morphisms \mathcal{M} and \mathcal{E} called *admissible monomorphisms* and *admissible epimorphisms*, respectively, satisfying the following:

- Augmented: the zero object $* \in \mathcal{C}$ is initial in \mathcal{M} and terminal in \mathcal{E} . Any morphism $* \rightarrow A$ is in \mathcal{M} , and any morphism $A \rightarrow *$ is in \mathcal{E} .
- Closure: \mathcal{M} and \mathcal{E} are closed under composition and contain all isomorphisms.
- Bicartesian squares: a commutative square of the form

$$\begin{array}{ccc} \bullet & \rhd & \longrightarrow & \bullet \\ \downarrow & & & \downarrow \\ \bullet & \rhd & \longrightarrow & \bullet \end{array}$$

is cartesian if and only if it is cocartesian. We distinguish bicartesian squares with a \square in the center.

- Stable: Every span and cospan determine a bicartesian square,

$$\begin{array}{ccc} \bullet & \rhd & \longrightarrow & \bullet \\ \downarrow & & & \downarrow \\ \bullet & & & \bullet \end{array} \mapsto \begin{array}{ccc} \bullet & \rhd & \longrightarrow & \bullet \\ \downarrow & \square & \downarrow & \\ \bullet & \rhd & \longrightarrow & \bullet \end{array} \quad \text{and} \quad \begin{array}{ccc} \bullet & & & \bullet \\ \downarrow & & & \downarrow \\ \bullet & \rhd & \longrightarrow & \bullet \end{array} \mapsto \begin{array}{ccc} \bullet & \rhd & \longrightarrow & \bullet \\ \downarrow & \square & \downarrow & \\ \bullet & \rhd & \longrightarrow & \bullet \end{array}$$

Example 3.14. A proto-exact category determines a category with squares in a natural way. Moreover, using the universal properties of these bicartesian squares, one can check that these squares categories are stable. Note that the fact that squares are bicartesian also implies that both horizontal and vertical weak equivalences are isomorphisms. Then by Theorem 2.53, we have $|S_\bullet \square \mathcal{C}| \simeq |T_\bullet \mathcal{C}|$ as spaces.

Example 3.15. The squares category of finite sets is stable. Because of the symmetry of the squares, the cospan completion t may be defined just as the span completion s was in [Example 2.42](#).

Example 3.16. The polytope example [Example 2.14](#) is stable. Similarly to finite sets, stability follows from the definition of squares in \mathbb{P}_G^n and their symmetry.

Remark 3.17. In [\[FL91, Section 2.3\]](#), Fiedorowicz–Loday consider double categories that satisfy a condition very similar to [Definition 3.9\(iii\)](#) and show that every crossed simplicial group determines such a double category. In [\[FL91, Proposition 2.6\]](#), they further show that the classifying space of these double categories can be modeled by a generalized Q -construction. It would be interesting to consider when the K^\square -theory of a squares category can be modeled by a similar Q -construction, but this is beyond the scope of this paper.

3.3. 2-Segal objects from stable squares categories. The S_\bullet^\square -construction from [Definition 2.20](#) is precisely the one defined by Dyckerhoff–Kapranov for proto-exact categories. In particular, $S_\bullet^\square(\mathcal{C})$ is a simplicial groupoid when \mathcal{C} is proto-exact, and in [\[DK19, Proposition 2.4.8\]](#) Dyckerhoff–Kapranov use this to show that $[n] \mapsto BS_n(\mathcal{C})$ is a 2-Segal space. We can generalize their methods to stable squares categories.

When \mathcal{C} is a proto-Waldhausen category whose weak equivalences are isomorphisms, we can show that the elements of $S_n\mathcal{C}$ are completely determined by their top row. If \mathcal{C} is moreover stable, they are also determined by their rightmost column. In this subsection we prove these claims, and use them to obtain 2-Segal objects from stable squares categories.

Definition 3.18. Let \mathcal{C} be a squares category. We define $\mathcal{H}_\bullet\mathcal{C}$ as the simplicial category whose n -simplices have objects consisting of sequences

$$O \rightrightarrows A_1 \rightrightarrows \dots \rightrightarrows A_n$$

and whose morphisms are vertical natural transformations that are pointwise valued in $w^v\mathcal{C}$. The face and degeneracy maps behave like those of a nerve, except for $d_0: \mathcal{H}_n\mathcal{C} \rightarrow \mathcal{H}_{n-1}\mathcal{C}$ which sends the element above to

$$O \rightrightarrows B_1 \rightrightarrows \dots \rightrightarrows B_{n-1}$$

where B_j is obtained inductively by completing the span

$$\begin{array}{ccc} A_{j-1} & \rightrightarrows & A_j \\ \downarrow & & \\ B_{j-1} & & \end{array}$$

for $j = 2, \dots, n$ (with $B_0 = O$).

Definition 3.19. Similarly, we define $\mathcal{V}_*\mathcal{C}$ as the simplicial category whose n -simplices have objects consisting of sequences

$$A_1 \rightarrow \dots \rightarrow A_n \rightarrow O$$

and whose morphisms are vertical natural transformations that are pointwise valued in $w^v\mathcal{C}$. The face and degeneracy maps behave like those of a nerve, except for $d_n: \mathcal{V}_n\mathcal{C} \rightarrow \mathcal{V}_{n-1}\mathcal{C}$ which sends the element above to

$$B_1 \rightarrow \dots \rightarrow B_{n-1} \rightarrow O$$

where B_{j-1} is obtained inductively by completing the cospan

$$\begin{array}{ccc} & A_{j-1} & \\ & \downarrow & \\ B_j & \rightarrow & A_j \end{array}$$

for $j = n, \dots, 2$ (with $B_n = O$).

Definition 3.20. A squares category \mathbb{C} is *isostable* if it is a stable squares category whose weak equivalences are invertible, and moreover given

$$\begin{array}{ccc} A \xrightarrow{f} B & & C \xrightarrow{k} D \\ g \downarrow \cong & \cong \downarrow h & g^{-1} \downarrow \cong \\ C \xrightarrow{k} D & & A \xrightarrow{f} B \end{array},$$

the left diagram is a square in \mathbb{C} if and only if the right one is.

The purpose of [Definition 3.20](#) is to ensure the following lemma holds.

Lemma 3.21. *If \mathbb{C} is isostable, then $S_{\bullet}^{\square}\mathbb{C}$ is a simplicial groupoid.*

Proof. If $w^v\mathbb{C}$ consists of invertible morphisms, then every morphism in $S_n^{\square}\mathbb{C}$ is pointwise invertible. Under the conditions of [Definition 3.20](#), such a natural transformation admits an inverse natural transformation, whose components are the pointwise inverses. \square

Remark 3.22. It is not enough to assume that the vertical weak equivalences are all invertible to conclude that $S_n^{\square}\mathbb{C}$ is a groupoid — one further needs to ensure that squares are appropriately invertible. The subtlety is that, unlike in a 1-categorical setting, a vertical natural transformation of double functors which is pointwise an isomorphism may not admit an inverse natural transformation. Indeed, suppose we have a vertical natural transformation $\tau: F \Rightarrow G$ between double functors $F, G: \mathbb{C} \rightarrow \mathbb{D}$ such that each component τ_C is a (vertical) isomorphism. In order for the maps τ_C^{-1} to assemble into a vertical natural transformation, we must now verify that for each horizontal map $f: C \rightarrow C'$ in \mathbb{C} we have a square in \mathbb{D}

$$\begin{array}{ccc} GC \xrightarrow{Gf} GC' \\ \tau_C^{-1} \downarrow \cong & \cong \downarrow \tau_{C'}^{-1} \\ FC \xrightarrow{Ff} FC' \end{array}$$

which is not necessarily guaranteed unless we impose the conditions of [Definition 3.20](#), which are relatively mild in practice.

Remark 3.23. Suppose \mathbb{C} is a stable squares category whose weak equivalences are isomorphisms. A sufficient condition for \mathbb{C} to be isostable is to be able to choose span and cospan completion functors s, t that behave a certain way when one of the morphisms in the (co)span is an equality:

$$s: \begin{array}{ccc} A \xrightarrow{f} B \\ \parallel \\ A \end{array} \mapsto \begin{array}{ccc} A \xrightarrow{f} B \\ \parallel \quad \square \quad \parallel \\ A \xrightarrow{f} B \end{array} \quad \text{and} \quad s: \begin{array}{ccc} A \xlongequal{\quad} A \\ g \downarrow \\ C \end{array} \mapsto \begin{array}{ccc} A \xlongequal{\quad} A \\ g \downarrow \quad \square \quad \downarrow g \\ C \xlongequal{\quad} C \end{array}$$

and similarly for t . One can then deduce the final condition of isostability by first completing the span $A \xleftarrow{g^{-1}} C \xrightarrow{k} D$ and considering various compositions of squares.

Example 3.24. [Example 3.15](#) and [Example 3.16](#) are isostable. Hence, by [Theorem 3.30](#), their S_{\bullet}^{\square} -constructions yield 2-Segal spaces.

Lemma 3.25. *Let \mathbb{C} be an isostable squares category. The forgetful map $U: S_{\bullet}^{\square}\mathbb{C} \rightarrow \mathcal{H}_{\bullet}\mathbb{C}$ that takes an object to its top row is pointwise an equivalence of categories.*

Proof. We prove that each functor U_n is an equivalence of categories by constructing an inverse equivalence. To do this, we will use the constructions (and notation) from [Proposition 2.49](#) to define a section functor $F_n: \mathcal{H}_n\mathbb{C} \rightarrow S_n^{\square}\mathbb{C}$. Just as in [Proposition 2.49](#), the functor F_n takes a sequence in $\mathcal{H}_n\mathbb{C}$ to the staircase constructed by sequentially taking the span completions, which exist as \mathbb{C} is proto-Waldhausen. One can readily check that F_n thus constructed takes

maps in $\mathcal{H}_n\mathbb{C}$ to maps in $S_n^\square\mathbb{C}$; see for instance [Remark 2.27](#). Clearly $U_n F_n = \text{id}$, and we can construct a natural transformation $\tau: F_n U_n \Rightarrow \text{id}$ exactly as in [Proposition 2.49](#); it suffices to show that τ is an isomorphism. Note that the sections F_n do not assemble into a simplicial map, which is why we do not claim that U is a simplicial equivalence.

Now recall that each component $\tau_A: F_n U_n(A) \rightarrow A$ is a vertical natural transformation whose components are constructed inductively. For an arbitrary step, these are given by the composite

$$\begin{array}{ccccc}
 & & A_{i,j} & \xrightarrow{\quad} & A_{i,j+1} \\
 & & \parallel & & \parallel \\
 & & A_{i,j} & \xrightarrow{\quad} & A_{i,j+1} \\
 & \nearrow & \downarrow & & \downarrow \\
 & & A_{i+1,j} & \xrightarrow{\quad} & A_{i+1,j+1} \\
 & & \parallel & & \parallel \\
 D_{i,j} & \xrightarrow{\quad} & D_{i,j+1} & & \\
 & \downarrow & \parallel & & \downarrow \\
 & & A_{i+1,j} & \xrightarrow{\quad} & X \\
 & \nearrow & \downarrow & & \nearrow \\
 D_{i+1,j} & \xrightarrow{\quad} & D_{i+1,j+1} & &
 \end{array}$$

Here, $D_{ij} = F_n U_n(A)_{ij}$, X is the span completion of the middle face, and the map $X \rightarrow A_{i+1,j+1}$ is the component $w_{A_{i+1,j+1}}$ of the natural transformation given by condition (ii) of [Definition 2.38](#); hence, this map is a vertical isomorphism as all vertical weak equivalences in \mathbb{C} are isomorphisms by assumption. On the other hand, the map $D_{i+1,j+1} \rightarrow X$ is induced by the section s given by condition (i) of [Definition 2.38](#).

If we knew that the three given maps $D_{i,j} \twoheadrightarrow A_{i,j}$, $D_{i+1,j} \twoheadrightarrow A_{i+1,j}$ and $D_{i,j+1} \twoheadrightarrow A_{i,j+1}$ were vertical isomorphisms, then by [Remark 3.22](#) these would give an invertible morphism of spans. Hence, this would ensure that the induced map $D_{i+1,j+1} \twoheadrightarrow X$ is also a vertical isomorphism (since s preserves isomorphisms, by functoriality), and so the composite $D_{i+1,j+1} \twoheadrightarrow X \twoheadrightarrow A_{i+1,j+1}$ would be an isomorphism as well. This is indeed the case, as the corresponding maps are isomorphisms in the first inductive step (in fact, they are identities $A_{01} \rightarrow A_{01}$, $A_{02} \rightarrow A_{02}$ and $O \rightarrow O$).

Thus $\tau_A: F_n U_n(A) \rightarrow A$ is a vertical natural transformation which is pointwise a vertical isomorphism; by [Remark 3.22](#) this implies that each τ_A is invertible, and hence the natural transformation τ is itself invertible, as desired. \square

Lemma 3.26. *Let \mathbb{C} be an isostable squares category. The forgetful map $U: S_n^\square\mathbb{C} \rightarrow \mathcal{V}_n\mathbb{C}$ that takes an object to its rightmost column is pointwise an equivalence of categories.*

Proof. The proof is essentially the same as that of [Lemma 3.25](#); the main difference lies in the fact that we must use the cospan completions given by the section t in condition (iii) of [Definition 3.9](#), instead of span completions.

The functor t allows us to construct a section functor $G_n: \mathcal{V}_n\mathbb{C} \rightarrow S_n^\square\mathbb{C}$ analogous to the functor F_n in the proof of [Lemma 3.25](#). The fact that G_n takes maps in $\mathcal{V}_n\mathbb{C}$ to maps in $S_n^\square\mathbb{C}$ is less evident than its counterpart statement about F_n . To illustrate this, note for instance that given a map $f: A \rightarrow A'$ in $\mathcal{V}_n\mathbb{C}$, the first inductive step in the definition of $G_n f$ uses

the cospan completion functor t to produce a cube

$$\begin{array}{ccccc}
 & & Y' & \xrightarrow{\quad} & A'_{n-2,n} \\
 & \nearrow \text{---} & \downarrow & \nearrow & \downarrow \\
 Y & \xrightarrow{\quad} & A_{n-2,n} & & A'_{n-2,n} \\
 \downarrow & & \downarrow & & \downarrow \\
 & & O & \xrightarrow{\quad} & A'_{n-1,n} \\
 \downarrow & \parallel & \downarrow & \nearrow & \downarrow \\
 O & \xrightarrow{\quad} & A_{n-1,n} & & A'_{n-1,n} \\
 & & \downarrow & & \downarrow \\
 & & O & & O \\
 & & \downarrow & & \\
 & & O & &
 \end{array}$$

However, even knowing that $A_{n-1,n} \rightarrow A'_{n-1,n}$ and $A_{n-2,n} \rightarrow A'_{n-2,n}$ are weak equivalences, general abstract nonsense is not enough to guarantee that the map $Y \rightarrow Y'$ is also a weak equivalence (in contrast to the span completion scenario). In this case, the fact that the morphism of the cospans is a pointwise vertical isomorphism implies it is an isomorphism of cospans (using [Remark 3.22](#)) and consequently t must send this morphism to an isomorphism of squares. Hence $Y \rightarrow Y'$ is also a vertical isomorphism.

We still have that $U_n G_n = \text{id}$, and we can construct a natural transformation $\eta: G_n U_n \Rightarrow \text{id}$ analogous to the one defined in the proof of [Lemma 3.25](#), using the natural transformation $u: t j^* \Rightarrow \text{id}$ from condition (iv) of [Definition 3.9](#). Once again, we can show that η is invertible, using the functoriality of t and the fact that each vertical morphism u_A is a weak equivalence, which is why this additional condition is required in [Definition 3.9](#). \square

Remark 3.27. Our definition of stability was engineered for the two lemmas above to hold since, as we will soon see, they are instrumental in our strategy to obtain 2-Segal objects from squares categories. However, other avenues could be pursued to obtain these results as well:

- A detailed study of the proof of [Lemma 3.26](#) reveals that the section functor t is only applied to the subcategory $w^v \text{Fun}^v(\cdot \dashv \dot{\cdot}, \mathbb{C})$ of vertical natural transformations which are pointwise weak equivalences. With this in mind, one could modify condition (iii) in [Definition 3.9](#) and ask for a section t to the functor $j^*: w^v \text{Fun}^v(\dot{\cdot} \dashv \square \dot{\cdot}, \mathbb{C}) \rightarrow w^v \text{Fun}^v(\cdot \dashv \dot{\cdot}, \mathbb{C})$ instead.
- A stability definition where conditions (i), (ii) are truly dual to (iii), (iv) would likely consider horizontal natural transformations between the cospan and square diagrams, instead of vertical ones. In this approach, it would not be necessary to add the requirement that the natural transformation u is pointwise a weak equivalence, as this would be ensured by construction just as it is for w . The reason we choose not to do this is because we would not be able to prove [Lemma 3.26](#) where each staircase in the S_{\bullet}^{\square} -construction is determined by its rightmost column, since our definition of S_{\bullet}^{\square} has vertical natural transformations as its morphisms (see [Definition 2.20](#)). Instead, following this approach would require us to define a horizontal version of S_{\bullet}^{\square} as well, which would now be determined by its rightmost column whenever horizontal weak equivalences are isomorphisms, and then comparing the vertical and horizontal versions of S_{\bullet}^{\square} . These versions should agree as long as horizontal and vertical weak equivalences are in a bijective correspondence with each other in a way that is compatible with the squares in the double category. This holds, for instance, for any squares category arising from an ECGW-category [[SS21](#)].

- The additional condition that u is pointwise a weak equivalence would hold if the squares in \mathbb{C} satisfied the following property: in the picture below, whenever the diagram on the right and the outer diagram are squares in \mathbb{C} , then so is the diagram on the left.

$$\begin{array}{ccccc} A & \xrightarrow{\quad} & B & \xrightarrow{\quad} & C \\ \downarrow & & \downarrow & & \downarrow \\ A' & \xrightarrow{\quad} & B' & \xrightarrow{\quad} & C' \end{array}$$

If so, we could do an argument similar to the one in [Remark 2.27](#). This property is true, for instance, if the squares in \mathbb{C} are the cartesian squares in some ambient category. In this case, the assumption that \mathbb{C} is isostable is also automatic, as identity squares are always squares in any double category.

We now follow the proof of [\[DK19, Proposition 2.4.8\]](#) to show that the S_{\bullet}^{\square} -construction of an isostable squares category produces a 2-Segal space. The idea is to use the comparisons with $\mathcal{H}_{\bullet}\mathbb{C}$ and $\mathcal{V}_{\bullet}\mathbb{C}$, and show the desired equivalences for these categories instead. The following two lemmas are the equivalences we will need.

Lemma 3.28. *The map*

$$B\mathcal{V}_n(\mathbb{C}) \rightarrow B\mathcal{V}_{\{0,\dots,n-2,n\}}(\mathbb{C}) \times_{B\mathcal{V}_{\{n-2,n\}}(\mathbb{C})}^h B\mathcal{V}_{\{n-2,n-1,n\}}(\mathbb{C})$$

is a homotopy equivalence for all $n \geq 3$.

Proof. We will show that the functors

$$\psi_n: \mathcal{V}_n(\mathbb{C}) \rightarrow \mathcal{V}_{\{0,\dots,n-2,n\}}(\mathbb{C}) \times_{\mathcal{V}_{\{n-2,n\}}(\mathbb{C})}^{(2)} \mathcal{V}_{\{n-2,n-1,n\}}(\mathbb{C})$$

are equivalences after realization for all $n \geq 3$. The target of ψ_n is a projective 2-limit of categories, described as follows (see [\[DK19, Definition 1.3.6\]](#) for a general definition):

- An object is the data of objects

$$\begin{aligned} C_1 &\rightarrow \dots \rightarrow C_{n-2} \rightarrow 0 \in \mathcal{V}_{n-1}(\mathbb{C}), \\ D_{n-2} &\rightarrow D_{n-1} \rightarrow 0 \in \mathcal{V}_2(\mathbb{C}) \\ C &\rightarrow 0 \in \mathcal{V}_1(\mathbb{C}) \end{aligned}$$

along with a span of vertical isomorphisms $C_{n-2} \leftarrow^{\cong} C \xrightarrow{\cong} D_{n-2}$.

- A morphism $(f_*, g_*, h): (C_*, D_*, C) \rightarrow (C'_*, D'_*, C')$ is the data of morphisms $f_*: C_* \rightarrow C'_* \in \mathcal{V}_{n-1}(\mathbb{C})$, $g_*: D_* \rightarrow D'_* \in \mathcal{V}_2(\mathbb{C})$, and $h: C \rightarrow C' \in \mathcal{V}_1(\mathbb{C})$ so that the diagram

$$\begin{array}{ccccc} C_{n-2} & \leftarrow^{\cong} & C & \xrightarrow{\cong} & D_{n-2} \\ \downarrow f_j & & \downarrow & & \downarrow g_j \\ C'_{n-2} & \leftarrow^{\cong} & C' & \xrightarrow{\cong} & D'_{n-2} \end{array}$$

commutes.

The projective 2-limit models the homotopy limit when the categories involved are groupoids (c.f. [\[DK19, Proposition 1.3.8\]](#)) and hence it suffices to show ψ_n induces an equivalence after geometric realization, as then

$$B\mathcal{V}_n(\mathbb{C}) \xrightarrow{\simeq} B \left(\mathcal{V}_{\{0,\dots,n-2,n\}}(\mathbb{C}) \times_{\mathcal{V}_{\{n-2,n\}}(\mathbb{C})}^{(2)} \mathcal{V}_{\{n-2,n-1,n\}}(\mathbb{C}) \right) \xrightarrow{\simeq} B\mathcal{V}_{n-1}(\mathbb{C}) \times_{B\mathcal{V}_1(\mathbb{C})}^h B\mathcal{V}_2(\mathbb{C}),$$

since $\mathcal{V}_*(\mathbb{C})$ is a simplicial groupoid.

We can represent an object (C_*, D_*, C) as a commutative diagram

$$\begin{array}{ccccc}
 & & & & C_1 \\
 & & & & \downarrow \\
 & & & & \Downarrow \\
 & & & & \vdots \\
 & & & & \downarrow \\
 D_{n-2} & \xleftarrow{\cong} & C & \xrightarrow{\cong} & C_{n-2} \\
 \downarrow & & \downarrow & & \downarrow \\
 \Downarrow & & \Downarrow & & \Downarrow \\
 D_{n-1} & & & & \\
 \downarrow & & \downarrow & & \downarrow \\
 \Downarrow & & \Downarrow & & \Downarrow \\
 0 & \xlongequal{\quad} & 0 & \xlongequal{\quad} & 0
 \end{array}$$

From such a diagram, we produce an element of $\mathcal{V}_n(\mathbb{C})$ as

$$0 \rightarrow C_1 \rightarrow \dots \rightarrow C_{n-2} \rightarrow D_{n-1} \rightarrow O$$

where the penultimate morphism is the composition $C_{n-2} \xrightarrow{\cong} C \xrightarrow{\cong} D_{n-2} \longrightarrow D_{n-1}$. It is straightforward to check that this assignment extends to a functor

$$q_n: \mathcal{V}_{\{0, \dots, n-2, n\}}(\mathbb{C}) \times_{\mathcal{V}_{\{n-2, n\}}(\mathbb{C})}^{(2)} \mathcal{V}_{\{n-2, n-1, n\}}(\mathbb{C}) \rightarrow \mathcal{V}_n(\mathbb{C})$$

such that $q_n \circ \psi_n = \text{id}$ and there is a natural transformation $\text{id} \Rightarrow \psi_n \circ q_n$. The component of this natural transformation on an object (C_*, D_*, C) is the morphism with $f_* = \text{id}$, g_* the identity everywhere except the first component where it is the composition $D_{n-2} \xrightarrow{\cong} C \xrightarrow{\cong} C_{n-2}$, and h is given by the commutative diagram

$$\begin{array}{ccccc}
 C_{n-2} & \xleftarrow{\cong} & C & \xrightarrow{\cong} & D_{n-2} \\
 \parallel & & \downarrow \cong & & \downarrow \cong \\
 C_{n-2} & \xlongequal{\quad} & C_{n-2} & \xlongequal{\quad} & C_{n-2}
 \end{array}$$

By the realization lemma, this implies ψ_n is an equivalence after taking classifying spaces, and so we obtain the desired result. \square

Lemma 3.29. *The map*

$$B\mathcal{H}_n(\mathbb{C}) \rightarrow B\mathcal{H}_{\{0,1,2\}}(\mathbb{C}) \times_{B\mathcal{H}_{\{0,2\}}(\mathbb{C})}^h B\mathcal{H}_{\{0,2, \dots, n\}}(\mathbb{C})$$

is an equivalence for all $n \geq 3$.

Proof. The proof for $\mathcal{H}_*(\mathbb{C})$ follows a similar idea as for $\mathcal{V}_*(\mathbb{C})$, but the arguments are more complicated as we need to accommodate the double categorical structure present in $\mathcal{H}_n(\mathbb{C})$. We are crucially making use of the fact that \mathbb{C} is isostable to ensure that $\mathcal{H}_\bullet(\mathbb{C})$ is a simplicial groupoid (see the argument in [Lemma 3.21](#) as well as [Remark 3.22](#)).

It again suffices to show that the functors

$$\varphi_n: \mathcal{H}_n(\mathbb{C}) \rightarrow \mathcal{H}_{\{0,1,2\}}(\mathbb{C}) \times_{\mathcal{H}_{\{0,2\}}(\mathbb{C})}^{(2)} \mathcal{H}_{\{0,2, \dots, n\}}(\mathbb{C})$$

are equivalences. In this case, an object of the target category is of the form

$$\begin{array}{ccccccc}
 0 & \twoheadrightarrow & C_1 & \twoheadrightarrow & C_2 & & \\
 \parallel & & \square & & \uparrow \cong & & \\
 0 & \twoheadrightarrow & & \twoheadrightarrow & C & & \\
 \parallel & & \square & & \downarrow \cong & & \\
 0 & \twoheadrightarrow & & \twoheadrightarrow & D_2 & \twoheadrightarrow & \dots \twoheadrightarrow D_n
 \end{array}$$

and a morphism $(f_*, g_*, h): (C_*, C, D_*) \rightarrow (C'_*, D'_*, C')$ consists of $f_* \in \mathcal{H}_2(\mathbb{C})$, $g_* \in \mathcal{H}_{n-2}(\mathbb{C})$, and $h \in \mathcal{H}_1(\mathbb{C})$ such that

$$\begin{array}{ccccc}
 C_2 & \xleftarrow{\cong} & C & \xrightarrow{\cong} & D_2 \\
 \downarrow f_j & & \downarrow h & & \downarrow g_j \\
 C'_2 & \xleftarrow{\cong} & C' & \xrightarrow{\cong} & D'_2
 \end{array}$$

commutes.

To see that φ_n is an equivalence, we again construct a functor in the other direction which will be a homotopy inverse for φ_n after realization. Unlike in $\mathcal{V}_n(\mathbb{C})$, we cannot make use of

$$C_2 \xrightarrow{\cong} C \xrightarrow{\cong} D_2 \twoheadrightarrow D_3$$

since we cannot compose the horizontal and vertical morphisms. However, given an element in $\mathcal{H}_{\{0,1,2\}}(\mathbb{C}) \times_{\mathcal{H}_{\{0,2\}}(\mathbb{C})}^{(2)} \mathcal{H}_{\{0,2,\dots,n\}}(\mathbb{C})$, we obtain a diagram

$$\begin{array}{ccccccc}
 0 & \twoheadrightarrow & & \twoheadrightarrow & D_2 & \twoheadrightarrow & \dots \twoheadrightarrow D_n \\
 \parallel & & \square & & \downarrow \cong & & \\
 0 & \twoheadrightarrow & & \twoheadrightarrow & C & & \\
 \parallel & & \square & & \downarrow \cong & & \\
 0 & \twoheadrightarrow & C_1 & \twoheadrightarrow & C_2 & &
 \end{array}$$

by inverting the given isomorphism in $\mathcal{H}_1(\mathbb{C})$ between $0 \twoheadrightarrow D_2$ and $0 \twoheadrightarrow C$. Now complete the bottom row to $0 \twoheadrightarrow C_1 \twoheadrightarrow C_2 \twoheadrightarrow C'_3 \twoheadrightarrow \dots \twoheadrightarrow C'_n$ where C'_i is inductively constructed by completing the span

$$\begin{array}{ccc}
 D_{i-1} & \twoheadrightarrow & D_i \\
 \cong \downarrow & & \\
 C'_{i-1} & &
 \end{array}$$

for $3 \leq i \leq n$, with $C'_2 = C_2$. This assignment on objects extends to a functor $r_n: \mathcal{H}_{\{0,1,2\}}(\mathbb{C}) \times_{\mathcal{H}_{\{0,2\}}(\mathbb{C})}^{(2)} \mathcal{H}_{\{0,2,\dots,n\}}(\mathbb{C}) \rightarrow \mathcal{H}_n(\mathbb{C})$; the components of the natural transformation $r_n(f_*, g_*, h)$ which are not identities are produced by the span-completion functor s .

We claim that there are vertical natural transformations $\text{id} \Rightarrow \varphi_n \circ r_n$ and $\text{id} \Rightarrow r_n \circ \varphi_n$, which (by the realization lemma) completes the proof. A component of the first natural

where the vertical maps are induced by the forgetful functor. By [Lemma 3.25](#) and [Lemma 3.29](#), the vertical functors and bottom horizontal functors are equivalences after realization, and hence the top horizontal functor is as well.

Similarly, for Ψ_n , consider the commutative diagram

$$\begin{array}{ccccc} S_n^\square(\mathbb{C}) & \xrightarrow{\Psi_n} & S_{\{0,\dots,n-2,n\}}^\square(\mathbb{C}) \times_{S_{\{n-2,n\}}^\square(\mathbb{C})}^{(2)} & S_{\{0,\dots,n-2\}}^\square(\mathbb{C}) & \\ \downarrow & & & \downarrow & \\ \mathcal{V}_n\mathbb{C} & \xrightarrow{\varphi_n} & \mathcal{V}_{\{0,\dots,n-2,n\}}\mathbb{C} \times_{\mathcal{V}_{\{n-2,n\}}(\mathbb{C})}^{(2)} & \mathcal{V}_{\{n-2,n-1,n\}}\mathbb{C} & \end{array}$$

where the vertical maps are induced by the forgetful functor, and apply [Lemma 3.26](#) and [Lemma 3.28](#). \square

Remark 3.31. In particular, stable squares categories are proto-Waldhausen, and so by [Theorem 2.53](#), this S_\bullet^\square -construction provides an alternative model for their squares K -theory. We can then say that there is a model for the algebraic K -theory of a stable squares category with isomorphisms which produces a 2-Segal space.

Note that in order to say this, a passage from T_\bullet to S_\bullet^\square (and the corresponding comparison) is truly required. Indeed, the realization of the T_\bullet -construction does not generally produce a 2-Segal space even when all weak equivalences are isomorphisms, as $T_\bullet(\mathbb{C})$ is not a simplicial groupoid. For this to happen, *all vertical morphisms* in \mathbb{C} must be isomorphisms, which is not the case in any examples of interest.

APPENDIX A. A NOTE ON WALDHAUSEN'S ADDITIVITY THEOREM FOR SQUARES

Waldhausen's additivity theorem is a fundamental result in higher algebraic K -theory that formalizes the idea that K -theory should “split” certain three-term sequences. In particular, Waldhausen shows that a cofiber sequence of functors $F' \twoheadrightarrow F \twoheadrightarrow F''$ yields homotopic maps $K(F) \sim K(F') \vee K(F'')$ on K -theory spectra [[Wal83](#)]. This additivity theorem can be viewed as the characterizing feature of K -theory, an idea which is made precise in [[BGT13](#)].

In the setting of squares categories [[Cam+23](#)] (see [Definition 2.5](#)), we can wonder whether there is an analogue of Waldhausen's additivity theorem. A reasonable first idea would be to try to lift the K_0^\square -relation

$$[D] + [A] = [B] + [C] \text{ whenever } \begin{array}{ccc} A & \twoheadrightarrow & B \\ \downarrow & \square & \downarrow \\ C & \twoheadrightarrow & D \end{array}$$

to a similar relation on K^\square -theory spaces. Inspired by cofiber sequences of functors, we could introduce a notion of a *square of functors*

$$\begin{array}{ccc} F_0 & \twoheadrightarrow & F_1 \\ \downarrow & \square & \downarrow \\ F_2 & \twoheadrightarrow & F_3 \end{array}$$

which (among other things) would yield a square when evaluated on any object, and ask whether $K^\square F_0 \vee K^\square F_3 \simeq K^\square F_1 \vee K^\square F_2$. However, in the double categorical setting, there is the subtlety that we cannot simply speak of natural transformations, but must choose vertical or horizontal natural transformations, both of which are quite structured in the following sense.

Proposition A.1. *The components of a vertical (resp. horizontal) natural transformation $\eta: F \rightrightarrows G$ of squares functors are valued in vertical (resp. horizontal) weak equivalences.*

Proof. Suppose η is a vertical natural transformation, and note that for every $O \twoheadrightarrow A$, we have a square

$$\begin{array}{ccc} O & \twoheadrightarrow & F(A) \\ \parallel & \square & \downarrow \eta_A \\ O & \twoheadrightarrow & G(A) \end{array},$$

which is to say that $F(A) \xrightarrow{\eta_A} G(A)$ is a vertical weak equivalence in the sense of [Definition 2.26](#). The proof for horizontal natural transformations is the same, using $A \twoheadrightarrow O$. \square

Thus asking for a square of functors comprised of horizontal and vertical natural transformations is very restrictive. On the other hand, “additivity” is immediate because we can obtain the desired homotopy by considering, e.g., the zig-zag of vertical natural transformations

$$F_0 \vee F_3 \Rightarrow F_2 \vee F_3 \Leftarrow F_2 \vee F_1.$$

and citing the fact that a vertical or natural transformation of double functors induces a homotopy after taking classifying spaces.

Rather than using the full double categorical setting, we could instead consider squares categories which have an ambient 1-category; such squares categories are called *categories with squares* in [\[Hoe+22\]](#). A *category with squares* is a 1-category \mathcal{C} that is given a double categorical structure by considering two subcategories of morphisms, the horizontal morphisms $\mathcal{C}^h (\twoheadrightarrow)$ and the vertical morphisms $\mathcal{C}^v (\twoheadrightarrow)$, along with a specified collection of distinguished squares. This data must satisfy certain conditions, detailed in [\[Hoe+22, Definition 3.1\]](#); for instance, we will assume that \mathcal{C} has a coproduct with unit O and that the pointwise coproduct of two distinguished squares is again distinguished. A functor between categories with squares is a functor of categories that preserves all the relevant structure. In a category with squares, we can define a square of functors without choosing vertical or horizontal natural transformations.

Definition A.2. A *square of functors* $F_*: \mathcal{C} \rightarrow \mathcal{D}$ is a diagram of natural transformations

$$\begin{array}{ccc} F_1 & \twoheadrightarrow & F_2 \\ \downarrow & \square & \downarrow \\ F_3 & \twoheadrightarrow & F_4 \end{array}$$

between squares functors which gives a distinguished square in \mathcal{D} when evaluated on an object of \mathcal{C} .

Question A.3. When does a square of functors as above induce $K^\square F_0 \vee K^\square F_3 \simeq K^\square F_1 \vee K^\square F_2$?

There is an equivalent formulation of this question, using an analogue of the extension category $\mathcal{E}(\mathcal{C})$. Recall that the objects of $\mathcal{E}(\mathcal{C})$ are cofiber sequences $A \twoheadrightarrow B \twoheadrightarrow C$ in a Waldhausen category \mathcal{C} , and that a cofiber sequence of functors $\mathcal{C} \rightarrow \mathcal{D}$ is equivalent to a single functor $\mathcal{C} \rightarrow \mathcal{E}(\mathcal{D})$. The analogue in the squares setting is the following.

Definition A.4. Let \mathcal{C} be a category with squares and define $\mathcal{E}^\square(\mathcal{C}) \subseteq \text{Fun}(Ar[1], \mathcal{C})$ to be the full subcategory on objects whose image determine a distinguished square in \mathcal{C} . This subcategory inherits a category with squares structure from $\text{Fun}(Ar[1], \mathcal{C})$, given pointwise.

Example A.5. There is a square of functors $\mathcal{E}^\square(\mathcal{C}) \rightarrow \mathcal{C}$ given by

$$\begin{array}{ccc} \square & \twoheadrightarrow & \square \\ \downarrow & & \downarrow \\ \bullet \square & \twoheadrightarrow & \bullet \square \end{array},$$

where the position of the bullet indicates which element of the input square is selected. The pointwise structure of $\mathcal{E}^\square(\mathcal{C})$ implies that this is indeed an example of a square of functors.

Lemma A.6. *The data of a square of functors $\mathcal{C} \rightarrow \mathcal{D}$ is equivalent to the data of a squares functor $\mathcal{C} \rightarrow \mathcal{E}^\square(\mathcal{D})$.*

Proof. Given a square of functors $F_*: \mathcal{C} \rightarrow \mathcal{D}$, define a functor $F: \mathcal{C} \rightarrow \mathcal{E}^\square(\mathcal{D})$ which sends an object C to the square

$$\begin{array}{ccc} F_0(C) & \xrightarrow{\quad} & F_1(C) \\ \downarrow & \square & \downarrow \\ F_2(C) & \xrightarrow{\quad} & F_3(C) \end{array} .$$

The conditions on F_* ensure that this assignment on objects extends to a squares functor. Conversely, given $F: \mathcal{C} \rightarrow \mathcal{E}^\square(\mathcal{D})$, we can post-compose by the square of functors from [Example A.5](#) to obtain a square of functors $\mathcal{C} \rightarrow \mathcal{D}$. \square

Remark A.7. We note that the definition of $\mathcal{E}^\square(\mathcal{C})$ generalizes to the double categorical setting, where one replaces $Ar[1]$ with the double category \mathbb{I}_1 mentioned just before [Definition 2.38](#), and captures the notion of double categorical squares of functors mentioned previously.

Proposition A.8. *The following formulations of squares additivity are equivalent:*

- (1) *The two functors $\square^\bullet \vee \bullet\square, \bullet\square \vee \square^\bullet: \mathcal{E}^\square(\mathcal{C}) \Rightarrow \mathcal{C}$ are homotopic after T_\bullet .*
- (2) *If*

$$\begin{array}{ccc} F_0 & \xrightarrow{\quad} & F_1 \\ \downarrow & \square & \downarrow \\ F_2 & \xrightarrow{\quad} & F_3 \end{array}$$

is a square of functors for $F_i: \mathcal{D} \rightarrow \mathcal{C}$, where \mathcal{D} is any other category with squares, then

$$T_\bullet F_0 \vee T_\bullet F_3 \simeq T_\bullet F_1 \vee T_\bullet F_2.$$

Proof. The implication (1) \Rightarrow (2) follows from [Lemma A.6](#), and the implication (2) \Rightarrow (1) follows from a naturality argument (apply (2) to the square of functors from [Example A.5](#)). \square

This is an analog of part of [[Wal83](#), Proposition 1.3.4], wherein Waldhausen gives two more equivalent formulations of the additivity theorem. The formulation of additivity that Waldhausen actually proves is that the functor $p: \mathcal{E}(\mathcal{C}) \rightarrow \mathcal{C} \times \mathcal{C}$ which sends $A \rightarrow C \rightarrow B$ to (A, B) induces an equivalence after wS_\bullet . This functor has a section i which sends (A, B) to the *split* cofiber sequence $A \rightarrow A \vee B \rightarrow B$, and hence showing $wS_\bullet p$ is a homotopy equivalence is equivalent to showing that $\varphi = i \circ p$ is homotopic to the identity after wS_\bullet .

The fact that every cofiber sequence $A \rightarrow C \rightarrow B$ can be functorially *split* $A \rightarrow A \vee B \rightarrow B$ is a consequence of the structure present in a Waldhausen category. However, in the squares setting, there is no clear analog of the functor φ . In [Appendix A.1](#), we propose a guiding philosophy that a category with squares needs the extra structure of “having split squares” in order to have this version of the additivity theorem. In [Appendix A.2](#), we detail how this philosophy manifests for Waldhausen categories via the Thomason construction and compare Waldhausen’s additivity theorem with the squares additivity theorem above.

Unfortunately, all known examples with “split squares” make use of some notion of a three-term sequence, even if they are not Waldhausen categories, and it is unclear how to prove squares additivity in these cases without relying on some pre-existing version of Waldhausen additivity (see [Appendix A.3](#) for a discussion of the example Mfld_d^{∂}). It is possible that a more novel approach to additivity could be developed for the squares context; in particular, one could try to develop a universal characterization as in [[BGT13](#)].

A.1. Split squares. A key observation at the heart of Waldhausen’s additivity theorem is that every cofiber sequence $A \twoheadrightarrow B \twoheadrightarrow C$ can be split into $A \twoheadrightarrow A \vee B \twoheadrightarrow B$. In the context of K^\square -theory, this raises the question *what is a split square?* Inspired by the observation that a split cofiber sequence $A \twoheadrightarrow A \vee B \twoheadrightarrow B$ may be written as a coproduct $(A = A \twoheadrightarrow *) \vee (* \twoheadrightarrow B = B)$ in $\mathcal{E}(\mathcal{C})$, we introduce the following definition of a split square.

Definition A.9. A square is *split* if it can be written as a nontrivial coproduct of squares in $\mathcal{E}^\square(\mathcal{C})$.

Recall that distinguished squares are closed under coproducts in \mathcal{C} , and so $\mathcal{E}^\square(\mathcal{C})$ inherits a coproduct from \mathcal{C} given pointwise. By an abuse of notation, we will write \vee for the coproduct on $\mathcal{E}^\square(\mathcal{C})$ as well as the one on \mathcal{C} . A split squares structure on \mathcal{C} is a way to functorially split squares nontrivially. Additionally, with an eye towards additivity, we will require that the resulting split squares satisfy the desired four-term relation. Since there is no *a priori* reason for an arbitrary category with squares to have split squares, we think of “having split squares” as extra structure.

Definition A.10. A *split squares structure* on a category with squares \mathcal{C} is a squares functor $\varphi: \mathcal{E}^\square(\mathcal{C}) \rightarrow \mathcal{E}^\square(\mathcal{C})$ such that there is a factorization of φ as

$$\mathcal{E}^\square(\mathcal{C}) \xrightarrow{\varphi_1 \times \varphi_2} \mathcal{E}^\square(\mathcal{C}) \times \mathcal{E}^\square(\mathcal{C}) \xrightarrow{\vee} \mathcal{E}^\square(\mathcal{C})$$

such that the squares functor $\square_{\bullet} \varphi \vee \square_{\bullet} \varphi$ is homotopic to $\square_{\bullet} \varphi \vee \square_{\bullet} \varphi$ after T_{\bullet} .

Although the functor φ is defined as extra structure, in order to imply an additivity theorem, φ needs to satisfy certain properties. In particular, we need to find a structure φ so that K^\square -theory cannot distinguish between a square and its associated split square.

Proposition A.11. *Suppose \mathcal{C} has split squares structure φ so that φ is homotopic to the identity after T_{\bullet} . Then either of the equivalent formulations of squares additivity in [Proposition A.8](#) hold.*

Proof. We will show that formulation (1) of [Proposition A.8](#) holds. Observe that the condition on φ in [Definition A.10](#) implies the desired result holds if we restrict along a split squares structure $\varphi: \mathcal{E}^\square(\mathcal{C}) \rightarrow \mathcal{E}^\square(\mathcal{C})$, and so it suffices to know that φ is homotopic to the identity after T_{\bullet} , which is condition (ii). \square

Remark A.12. In the case of Waldhausen categories, the functor that splits cofiber sequences comes for free from the Waldhausen structure. Waldhausen shows in [[Wal83](#), §1.4] that every Waldhausen category has split cofiber sequences (in an analogous sense to [Definition A.10](#)) and moreover that the additivity theorem [[Wal83](#), Proposition 1.3.4] is equivalent to this split cofiber sequence structure being homotopic to the identity after wS_{\bullet} .

We note that, unlike in the Waldhausen setting, the conditions in [Proposition A.8](#) may not imply \mathcal{C} has split squares. To obtain such an implication, it would suffice to have a split squares structure φ with a square of functors on $\mathcal{E}^\square(\mathcal{C})$ such as

$$\begin{array}{ccc} \varphi_1 & \twoheadrightarrow & \text{id} \\ \downarrow & \square & \downarrow \\ O & \twoheadrightarrow & \varphi_2 \end{array},$$

where the bottom left is the constant functor on the square that is all identities on the object O .

Remark A.13. In many cases, split squares structures arise via a factorization:

$$\begin{array}{ccc} \mathcal{E}^\square(\mathcal{C}) & \xrightarrow{\varphi_1 \times \varphi_2} & \mathcal{E}^\square(\mathcal{C}) \times \mathcal{E}^\square(\mathcal{C}) \\ p \downarrow & \nearrow i_1 \times i_2 & \\ D(\mathcal{C}) & & \end{array}$$

so that (i) the squares functor $i := \vee \circ (i_1 \times i_2)$ is a section of p , and (ii) the two maps $\square_{\bullet} i \vee \square_{\bullet} i$ and $\square_{\bullet} i \vee \square_{\bullet} i$ from $D(\mathcal{C}) \rightarrow \mathcal{C}$ are homotopic after T_\bullet . We think of $D(\mathcal{C})$ as providing the *data of a split square*. Proving that φ is homotopic to the identity after T_\bullet is then equivalent to proving that p induces a homotopy equivalence after T_\bullet .

In practice, given a split squares structure φ , verifying (ii) is quite difficult and is, in a sense, the content of the additivity theorem. It seems that one could use different proofs in different contexts, depending on the specific structures present in (\mathcal{C}, φ) . For instance, if the category of squares is essentially a Waldhausen category, then one can try to adapt the proofs of Waldhausen [Wal83] or McCarthy [McC93], but often will encounter issues along the way; see Appendix A.3 for a discussion of the specific example of Mfld_d^{∂} .

A.2. A comparison with Waldhausen additivity. First, observe that every cofiber sequence of functors $F' \twoheadrightarrow F \twoheadrightarrow F''$ gives a square of functors

$$\begin{array}{ccc} F' & \twoheadrightarrow & F \\ \downarrow & \square & \downarrow \\ * & \twoheadrightarrow & F'' \end{array}$$

where $*$ is the constant functor on the zero object, because every exact functor of Waldhausen categories induces a squares functor on the associated categories with squares (see Example 2.12). However, the converse is not necessarily true because a cofiber sequence of functors must satisfy that $F'(B) \cup_{F'(A)} F(A) \twoheadrightarrow F(B)$ for every cofibration $A \twoheadrightarrow B$, whereas this condition is not present for squares of functors.

Proposition A.14. *Suppose $F_*: \mathcal{C} \rightarrow \mathcal{D}$ is a square of exact functors between Waldhausen categories such that for all $A \twoheadrightarrow B$, the commutative diagram*

$$\begin{array}{ccc} F_i(A) & \twoheadrightarrow & F_i(B) \\ \downarrow & & \downarrow \\ F_{i+1}(A) & \twoheadrightarrow & F_{i+1}(B) \end{array}$$

has the property that $F_{i+1}(A) \cup_{F_i(A)} F_i(B) \twoheadrightarrow F_{i+1}(B)$ is a cofibration, for $i = 0, 2$. Then there are exact functors $F_1/F_0, F_3/F_2: \mathcal{C} \rightarrow \mathcal{D}$ so that

$$F_0 \twoheadrightarrow F_1 \twoheadrightarrow F_1/F_0 \quad \text{and} \quad F_2 \twoheadrightarrow F_3 \twoheadrightarrow F_3/F_2$$

are cofiber sequences of functors and a weak equivalence $F_1/F_0 \Rightarrow F_3/F_2$.

Along the same line of reasoning, one needs to be careful about the horizontal morphisms in $\mathcal{E}^\square(\mathcal{C})$ in order to obtain a squares formulation of additivity that holds for Waldhausen categories. In particular, one would like to define a split squares structure φ as

$$\begin{array}{ccc} A \twoheadrightarrow B & & A \twoheadrightarrow A \vee B/A & = & A \xlongequal{\quad} A & \vee & * \twoheadrightarrow B/A \\ \downarrow \square \downarrow & \rightsquigarrow & \downarrow \square \downarrow & = & \downarrow \square \downarrow & \vee & \downarrow \square \downarrow \\ C \twoheadrightarrow D & & C \twoheadrightarrow C \vee D/C & = & C \xlongequal{\quad} C & \vee & * \twoheadrightarrow D/C \end{array} .$$

However, this assignment does not extend to a squares functor on $\mathcal{E}^\square(\mathcal{C})$ as currently defined. Rather, one needs to consider a subcategory of horizontal morphisms which are those

$$\begin{array}{ccc} A \twoheadrightarrow B & & A' \twoheadrightarrow B' \\ \downarrow \square \downarrow & \mapsto & \downarrow \square \downarrow \\ C \twoheadrightarrow D & & C' \twoheadrightarrow D' \end{array}$$

so that $A \twoheadrightarrow A'$ and $C \twoheadrightarrow C'$, but additionally

$$B \cup_A A' \twoheadrightarrow B' \quad \text{and} \quad D \cup_C C' \twoheadrightarrow D',$$

which is the same additional condition imposed on cofiber sequences of functors. Let $\mathcal{E}_\varphi^\square(\mathcal{C}) \subseteq \mathcal{E}^\square(\mathcal{C})$ denote this subcategory with squares (where the vertical morphisms and squares are the same as in $\mathcal{E}^\square(\mathcal{C})$). Note that the Waldhausen category $\mathcal{E}(\mathcal{C})$ can be viewed as a full subcategory with squares of $\mathcal{E}_\varphi^\square(\mathcal{C})$ and $\varphi|_{\mathcal{E}^\square(\mathcal{C})}$ is the endofunctor on $\mathcal{E}(\mathcal{C})$ considered by Waldhausen.

Now, a squares functor $\mathcal{D} \rightarrow \mathcal{E}_\varphi^\square(\mathcal{C})$ specifies a slightly different version of a square of functors than [Definition A.2](#), but this version is the correct one to compare to Waldhausen's. In particular, formulation (2) of [Proposition A.8](#) is equivalent to [[Wal83](#), Proposition 1.4.3(iv)], although one needs to specify that the functors involved are exact; the subtlety is that a squares functor between Waldhausen categories may only be *weakly exact* (see [Remark 2.34](#)), although one could certainly consider cofiber sequences of weakly exact functors instead (and adapt the proof of additivity for the S_\bullet^\square -construction of [Definition 2.20](#)).

Remark A.15. Essentially the same ideas we have discussed work in a setting where one can take complements rather than quotients, such as finite (unpointed) sets or polytopes. One can then develop a similar comparison to additivity for subtractive Waldhausen categories [[Cam19](#)].

A.3. A discussion of squares additivity for Mfld_d^∂ . In this final subsection, we discuss the issues that arise when one tries to prove squares additivity in the specific case of the category with squares Mfld_d^∂ from [[Hoe+22](#)], where the objects are (smooth, compact, orientable) d -manifolds with boundary and the morphisms are embeddings with an additional condition on the boundary which we will refer to as *SK-embeddings*. The crucial property is that if $f: N \hookrightarrow M$ is a *SK-embedding*, then the complement $\overline{M \setminus N}$ is again an object of Mfld_d^∂ .

The horizontal morphisms and vertical morphisms of Mfld_d^∂ are all morphisms and the squares are pushout squares. We would like to define a split squares structure φ on objects by

$$\begin{array}{ccc} N \hookrightarrow M' & & N \xlongequal{\quad} N & \amalg & \emptyset \hookrightarrow \overline{M' \setminus N} \\ \downarrow \square \downarrow & \mapsto & \parallel \square \parallel & & \downarrow \square \downarrow \\ M \hookrightarrow W & & N \xlongequal{\quad} N & \amalg & \overline{M \setminus N} \hookrightarrow \overline{M \setminus N} \amalg \overline{M' \setminus N} \end{array},$$

noting that this definition satisfies the conditions of [Definition A.10](#) and that the data of a split square (in the sense of [Remark A.13](#)) is $D(\text{Mfld}_d^\partial) = (\text{Mfld}_d^\partial)^{\times 3}$; in particular, p sends a square to $(N, \overline{M \setminus N}, \overline{M' \setminus N})$ and the section i sends (A, B, C) to the square

$$\begin{array}{ccc} A \longrightarrow A \amalg B \\ \downarrow \square \downarrow \\ C \amalg A \longrightarrow C \amalg A \amalg B \end{array}.$$

We encounter an immediate issue as φ does not extend to a functor on all of $\mathcal{E}^\square(\text{Mfld}_d^\partial)$, since a morphism of squares

$$\begin{array}{ccc} N & \hookrightarrow & M_0 \\ \downarrow & \square & \downarrow \\ M_1 & \hookrightarrow & W \end{array} \rightsquigarrow \begin{array}{ccc} N' & \hookrightarrow & M'_0 \\ \downarrow & \square & \downarrow \\ M'_1 & \hookrightarrow & W' \end{array}$$

may not induce a morphism after φ as there is no guarantee that we have an SK -embedding $\overline{M_i \setminus N} \hookrightarrow \overline{M'_i \setminus N'}$. For example, in the following commutative diagram of SK -embeddings

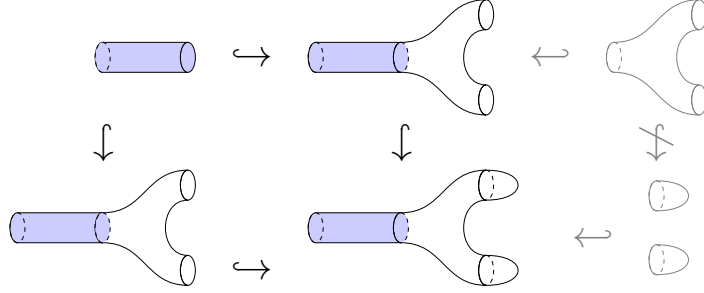

there is not an induced map on the relevant complements (in gray). To fix this issue, we could impose a condition analogous to the one Waldhausen puts on cofibrations in $\mathcal{E}(\mathcal{C})$ as discussed in the previous subsection (see also the “good squares” in [SS21]).

Definition A.16. Let $\mathcal{E}_\varphi^\square(\text{Mfld}_d^\partial) \subseteq \mathcal{E}^\square(\text{Mfld}_d^\partial)$ denote the wide subcategory on morphisms of squares above which additionally induce SK -embeddings $\overline{M_i \setminus N} \hookrightarrow \overline{M'_i \setminus N'}$ for $i = 0, 1$.

Then a squares functor $\mathcal{C} \rightarrow \mathcal{E}_\varphi^\square(\text{Mfld}_d^\partial)$ specifies a square of functors $F_* : \mathcal{C} \rightarrow \text{Mfld}_d^\partial$ that additionally satisfies the conditions that for any $A \rightarrow B$ in \mathcal{C} , there are induced morphisms $F_{i+1}(A) \setminus F_i(A) \rightarrow F_{i+1}(B) \setminus F_i(B)$ for $i = 0, 2$; this is just asking for $F_1 \setminus F_0$ and $F_3 \setminus F_2$ to be well-defined squares functors $\mathcal{C} \rightarrow \text{Mfld}_d^\partial$. To show that squares additivity holds for this notion of square of functors, there are two immediate avenues one would think to pursue:

- (1) Prove that $\varphi : \mathcal{E}_\varphi^\square(\text{Mfld}_d^\partial) \rightarrow \mathcal{E}^\square(\text{Mfld}_d^\partial)$ is homotopic to the identity after T_\bullet .
- (2) Prove that $p : \mathcal{E}_\varphi^\square(\text{Mfld}_d^\partial) \rightarrow (\text{Mfld}_d^\partial)^{\times 3}$ is an equivalence after T_\bullet .

For ease of notation, we will now write $\mathcal{M} := \text{Mfld}_d^\partial$ and $\mathcal{E} := \mathcal{E}_\varphi^\square(\text{Mfld}_d^\partial)$. One approach to (1) is to try and construct a simplicial homotopy directly using the double nerve. Observe that there is a map $h : \mathbb{N}_0\mathcal{E} \rightarrow \mathbb{N}_1\mathcal{E}$ which takes a distinguished square to the following square of squares:

$$\begin{array}{ccc} \begin{array}{ccc} N & \hookrightarrow & N \amalg \overline{M \setminus N} \\ \downarrow & \square & \downarrow \\ N \amalg \overline{M' \setminus N} & \hookrightarrow & N \amalg \overline{M \setminus N} \amalg \overline{M' \setminus N} \end{array} & \rightsquigarrow & \begin{array}{ccc} N & \hookrightarrow & M \\ \downarrow & \square & \downarrow \\ N \amalg \overline{M' \setminus N} & \hookrightarrow & M \amalg \overline{M' \setminus N} \end{array} \\ \downarrow & & \downarrow \\ \begin{array}{ccc} N & \hookrightarrow & N \amalg \overline{M \setminus N} \\ \downarrow & \square & \downarrow \\ M' & \hookrightarrow & M' \amalg \overline{M \setminus N} \end{array} & \rightsquigarrow & \begin{array}{ccc} N & \hookrightarrow & M \\ \downarrow & \square & \downarrow \\ M' & \hookrightarrow & W \end{array} \end{array}$$

However, issues arise when trying to extend h to a simplicial homotopy on the entire double nerve.

For (2), one could try to mimic the proofs of Waldhausen and McCarthy. Indeed, one can translate McCarthy’s version of Quillen Theorem A (see e.g. [McC94, Proposition 3.4.5]) so that $T_\bullet p$ is a homotopy equivalence if and only if

$$\pi_\bullet : T_\bullet p | \mathcal{M}^{\times 3} \rightarrow T_\bullet \mathcal{M}^{\times 3}$$

is an equivalence, where $T_n p | \mathcal{M}^{\times 3}$ is the category whose objects are diagrams of the form

$$p(\square_0) \rightrightarrows \dots \rightrightarrows p(\square_n) \rightrightarrows (A_0, B_0, C_0) \rightrightarrows \dots \rightrightarrows (A_n, B_n, C_n)$$

in $T_n(\mathcal{M}^{\times 3}) \cong (T_n \mathcal{M})^{\times 3}$, where $\square_0 \rightrightarrows \dots \rightrightarrows \square_n$ is a length n sequence of horizontal morphisms in \mathcal{E} . The functor π_n sends a diagram as above to the sequence $(A_0, B_0, C_0) \rightrightarrows \dots \rightrightarrows (A_n, B_n, C_n)$, and has a section s_n given by sending $(A_0, B_0, C_0) \rightrightarrows \dots \rightrightarrows (A_n, B_n, C_n)$ to

$$p_i(A_0, B_0, C_0) = \dots = p_i(A_0, B_0, C_0) = (A_0, B_0, C_0) \rightrightarrows \dots \rightrightarrows (A_n, B_n, C_n).$$

We note that replacing $ps(A_0, B_0, C_0)$ with the initial object \emptyset will not extend to morphisms in $T_n p | \mathcal{M}^{\times 3}$, and there is no evident way to replace the simplicial category T_n with the simplicial set $t_n = \text{ob } T_n$. In particular, showing that $\varepsilon_n := s_n \circ \pi_n$ (the analogue of McCarthy’s E_n) is homotopic to the identity is essentially the same as showing $T_n \varphi$ is homotopic to the identity.

A final viable option for the specific example of Mfld_d^∂ is to return to a more Waldhausen-esque 3-term additivity theorem. In particular, as discussed in Example 2.15, one could model $T_\bullet \text{Mfld}_d^\partial$ by an augmented version of the S_\bullet^\square -construction for Mfld_d^∂ . It seems plausible that some formulation of additivity will hold for this augmented S_\bullet^\square -construction, particularly since the vertical weak equivalences in Mfld_d^∂ are diffeomorphisms, so one may instead work with the simplicial set of objects. However, as pursuing this idea would take us beyond the realm of squares additivity, we conclude our discussion here.

REFERENCES

- [Ber+18] J. Bergner, A. Osorno, V. Ozornova, M. Rovelli, and C. Scheimbauer. “2-Segal sets and the Waldhausen construction”. In: *Topology Appl* 235 (2018), pp. 445–484.
- [Ber+21] J. Bergner, A. Osorno, V. Ozornova, M. Rovelli, and C. Scheimbauer. “2-Segal objects and the Waldhausen construction”. In: *Algebra & Geometric Topology* 21 (2021), pp. 1267–1326.
- [BGT13] Andrew J. Blumberg, David Gepner, and Gonalo Tabuada. “A universal characterization of higher algebraic K -theory”. In: *Geom. Topol.* 17.2 (2013), pp. 733–838.
- [BM08] Andrew J. Blumberg and Michael A. Mandell. “The localization sequence for the algebraic K -theory of topological K -theory”. In: *Acta Math.* 200.2 (2008), pp. 155–179.
- [Bro+24] Francis Brown, Melody Chan, Søren Galatius, and Sam Payne. *Hopf algebras in the cohomology of \mathcal{A}_g , $\text{GL}_n(\mathbb{Z})$, and $\text{SL}_n(\mathbb{Z})$* . 2024. arXiv: 2405.11528.
- [Cam+23] Jonathan Campbell, Josefein Kuijper, Mona Merling, and Inna Zakharevich. *Algebraic K -theory for squares categories*. 2023. arXiv: 2310.02852.
- [Cam19] Jonathan A. Campbell. “The K -theory spectrum of varieties”. In: *Trans. Amer. Math. Soc.* 371 (2019).
- [Car20] Louis Carlier. “Incidence bicomodules, Möbius inversion and a Rota formula for infinity adjunctions”. In: *Algebraic and Geometric Topology* 20 (2020), pp. 169–213.
- [Car24] Tanner Nathan Carawan. *2-Segal maps associated to a category with cofibrations*. 2024. arXiv: 2405.11561.
- [CG24] Maxine E. Calle and Julian J. Gould. *A combinatorial K -theory perspective on the Edge Reconstruction Conjecture in graph theory*. 2024. arXiv: 2402.14986.
- [CK20] Louis Carlier and Joachim Kock. “Antipodes of monoidal decomposition spaces”. In: *Communications in Contemporary Mathematics* 22 (2020).

- [CZ22] Jonathan A. Campbell and Inna Zakharevich. “Dévissage and localization for the Grothendieck spectrum of varieties,” in: *Advances in Mathematics* 411 (2022).
- [CZ24] Jonathan A. Campbell and Inna Zakharevich. “Hilbert’s third problem and a conjecture of Goncharov”. In: *Advances in Mathematics* 451 (2024).
- [DK19] Tobias Dyckerhoff and Mikhail Kapranov. *Higher Segal Spaces*. Vol. 2244. Lecture Notes in Mathematics. Springer, 2019.
- [Dyc18] Tobias Dyckerhoff. “Higher Categorical Aspects of Hall Algebras”. In: *Building Bridges Between Algebra and Topology*. Ed. by Dolores Herbera, Wolfgang Pitsch, and Santiago Zarzuela. Cham: Springer International Publishing, 2018, pp. 1–61.
- [Fel+21] Matthew Feller, Richard Garner, Joachim Kock, May U. Proulx, and Mark Weber. “Every 2-Segal space is unital”. In: *Commun. Contemp. Math.* 23.2 (2021), Paper No. 2050055, 6. ISSN: 0219-1997,1793-6683.
- [Fel23] Matt Feller. “Quasi-2-Segal sets”. In: *Tunisian Journal of Mathematics* 5.2 (2023), pp. 327–367.
- [FL91] Zbigniew Fiedorowicz and Jean-Louis Loday. “Crossed Simplicial Groups and their Associated Homology”. In: *Transactions of the American Mathematical Society* 326.1 (1991), pp. 57–87. ISSN: 00029947. (Visited on 08/07/2024).
- [GKT18] Imma Gálvez-Carrillo, Joachim Kock, and Andrew Tonks. “Decomposition spaces, incidence algebras and Möbius inversion I: basic theory”. In: *Advances in Mathematics* 331 (2018), pp. 952–1015.
- [Gra19] Marco Grandis. *Higher Dimensional Categories: From Double To Multiple Categories*. World Scientific Publishing Company, 2019. ISBN: 9789811205125.
- [Hoe+22] Renee S. Hoekzema, Mona Merling, Laura Murray, Carmen Rovi, and Julia Semikina. “Cut and Paste Invariants of Manifolds via Algebraic K -Theory”. In: *Topology and its Applications* 316 (2022).
- [HRS22] Renee S. Hoekzema, Carmen Rovi, and Julia Semikina. *A K -theory spectrum for cobordism cut and paste groups*. 2022. arXiv: 2210.00682.
- [Kar+73] U. Karras, M. Kreck, W.D. Neumann, and E. Ossa. *Cutting and pasting of manifolds; SK -groups*. Mathematics Lecture Series 1. Boston, MA: Publish or Perish, Inc., 1973.
- [Koc03] Joachim Kock. *Frobenius Algebras and 2-D Topological Quantum Field Theories*. London Mathematical Society Student Texts. Cambridge University Press, 2003.
- [Mal23] Cary Malkiewich. *Scissors congruence K -theory is a Thom spectrum*. 2023. arXiv: 2210.08082.
- [McC93] Randy McCarthy. “On fundamental theorems of Algebraic K -theory”. In: *Topology* 32 (2 1993), pp. 325–328.
- [McC94] Randy McCarthy. “The cyclic homology of an exact category”. In: *Journal of Pure and Applied Algebra* 93 (3 1994), pp. 251–296.
- [OS24] Yasuaki Ogawa and Amit Shah. *Weak Waldhausen categories and a localization theorem*. 2024. arXiv: 2406.18091.
- [Pen17] Mark D Penney. *The universal Hall bialgebra of a double 2-Segal space*. 2017. arXiv: 1711.10194.
- [Pog17] Thomas Poguntke. *Higher Segal structures in algebraic K -theory*. 2017. arXiv: 1709.06510.
- [Seg73] Graeme Segal. “Configuration spaces and iterated loop spaces”. In: *Inventiones Math.* 21 (1973), pp. 231–221.
- [SS21] Maru Sarazola and Brandon Shapiro. *A Gillet-Waldhausen Theorem for chain complexes of sets*. 2021. arXiv: 2107.07701.
- [Ste19] Walker H. Stern. *2-Segal objects and algebras in spans*. 2019. arXiv: 1905.06671.
- [Wal17] Tashi Walde. *Hall monoidal categories and categorical modules*. 2017. arXiv: 1611.08241.

- [Wal83] Friedhelm Waldhausen. “Algebraic K -theory of spaces”. In: *Lecture Notes in Mathematics* 1126 (1983), pp. 318–419.
- [You18] Matthew B. Young. “Relative 2-Segal spaces”. In: *Algebraic and Geometric Topology* 18 (2018), pp. 975–1039.
- [Zak12] Inna Zakharevich. “Scissors Congruence as K -theory”. In: *Homotopy, Homology and Applications* 14.1 (2012).

DEPARTMENT OF MATHEMATICS, UNIVERSITY OF PENNSYLVANIA, PHILADELPHIA, PA 19104
Email address: `callem@sas.upenn.edu`

SCHOOL OF MATHEMATICS, UNIVERSITY OF MINNESOTA, MINNEAPOLIS MN, 55455
Email address: `maru@umn.edu`