

Subjectivity, Bayesianism, and Causality

Pedro A. Ortega

Abstract—Bayesian probability theory is one of the most successful frameworks to model reasoning under uncertainty. Its defining property is the interpretation of probabilities as degrees of belief in propositions about the state of the world relative to an inquiring subject. This essay examines the notion of subjectivity by drawing parallels between Lacanian theory and Bayesian probability theory, and concludes that the latter must be enriched with causal interventions to model agency. The central contribution of this work is an abstract model of the subject that accommodates causal interventions in a measure-theoretic formalisation. This formalisation is obtained through a game-theoretic *Ansatz* based on modelling the inside and outside of the subject as an extensive-form game with imperfect information between two players. Finally, I illustrate the expressiveness of this model with an example of causal induction.

Index Terms—Subjectivity; Bayesian Probability Theory; Causality

I. INTRODUCTION

EARLY modern thinkers of the Enlightenment—spurred by the developments of empirical science, modern political organisation, and the shift from collective religion to personal cults—found in the free, autonomous, and rational *subject* the *locus* on which to ground all of knowledge (Mansfield, 2000). Most notably, Descartes, with his axiom *cogito ergo sum* (‘I think, therefore I am’), put forward the idea that the thought process of the subject is an unquestionable fact from which all other realities derive—in particular of oneself, and in general of everything else (Descartes, 1637).

This proposition initiated a long-lasting debate among philosophers such as Rousseau and Kant, and its discussion played a fundamental rôle in shaping modern Western thought. Indeed, the concept of the subject operates at the heart of our core institutions: the legal and political organisation rests on the assumption of the free and autonomous subject for matters of responsibility of action and legitimisation of ruling bodies; capitalism, the predominant economic system, depends on forming, through the tandem system of education and marketing, subjects that engage in work and consumerism (Burkitt, 2008); natural sciences equate objective truth with inter-subjective experience (Kim, 2005); and so forth.

Nowadays, questions about subjectivity are experiencing renewed interest from the scientific and technological communities. Recent technological advances, such as the availability of massive and ubiquitous computational capacity, the internet, and improved robotic systems, have triggered the proliferation of autonomous systems that monitor, process and deploy information at a scale and extension that is unprecedented in history. Today we have social networks that track user

preferences and deliver personalised mass media, algorithmic trading systems that account for a large proportion of the trades at stock exchanges, unmanned vehicles that navigate and map unexplored terrain. What are the “users” that a social network aims to model? What does an autonomous system know and what can it learn? Can an algorithm be held responsible for its actions? Furthermore, latest progress in neuroscience has both posed novel questions and revived old ones, ranging from investigating the neural bases of perception, learning, and decision making, to understanding the nature of free will (Sejnowski and van Hemmen, 2006). Before these questions can be addressed in a way that is adequate for the mathematical disciplines, it is necessary to clarify what is meant by a subject in a way that enables a quantitative discussion.

The program of this essay is threefold. First, I will argue that Bayesian probability theory is a subjectivist theory, encoding many of our implicit cultural assumptions about subjectivity. To support this claim, I will show that some basic concepts in Bayesian probability theory have a counterpart in Lacanian theory, which is used in cultural studies as a conceptual framework to structure the discourse about subjectivity. In the second part, I will put forward the claim that Bayesian probability theory needs to be enriched with causal interventions to model agency. Finally, I will consolidate the ideas on subjectivity in an abstract mathematical synthesis. The main contribution of this formalisation is the measure-theoretic generalisation of causal interventions.

II. SUBJECTIVITY IN LACANIAN THEORY

To artificial intelligence, statistics, and economics, the questions about subjectivity are not novel at all: many can be traced back to the early discussions at the beginning of the twentieth century that eventually laid down the very foundations of these fields. Naturally, these ideas did not spring out of a vacuum, but followed the general trends and paradigms of the time. In particular, many of the fundamental concepts about subjectivity seem to have emerged from interdisciplinary cross-fertilisation.

For instance, in the humanities, several theories of subjectivity were proposed. These can be roughly subdivided into two dominant approaches (Mansfield, 2000): the *subjectivist/psychoanalytic* theories, mainly associated with Freud and Lacan, which see the subject as a *thing* that can be conceptualised and studied (see *e.g.* Freud, 1899; Fink, 1996); and the *anti-subjectivist* theories, mainly associated with the works of Nietzsche and Foucault, which regard any attempt at defining the subject as a *tool* of social control, product of the culture and power of the time (Nietzsche, 1887; Foucault, 1964).

For our discussion, it is particularly useful to investigate the

relation to Lacan¹, firstly because it is a subjectivist theory and secondly because its abstract nature facilitates establishing the relation to Bayesian probability theory. Some ideas that are especially relevant are the following.

The subject is a construct. There is a consensus among theorists (both subjectivist and anti-subjectivists) that the subject is not born into the world as a unified entity. Instead, her constitution as a unit is progressively built as she experiences the world (Mansfield, 2000). The specifics of this unity vary across the different accounts, but roughly speaking, they all take on the form of an acquired sense of separation between a *self* (inside) and the rest of the world (outside). For instance, during the early stages of their lives, children have to learn that their limbs belong to them. In Lacan for instance, this distinction is embodied in the terms *I* and *the Other* (Fig. 1a). Crucially, Lacan stresses that the subject is precisely this “membrane” between inward and outward flow (Fink, 1996).

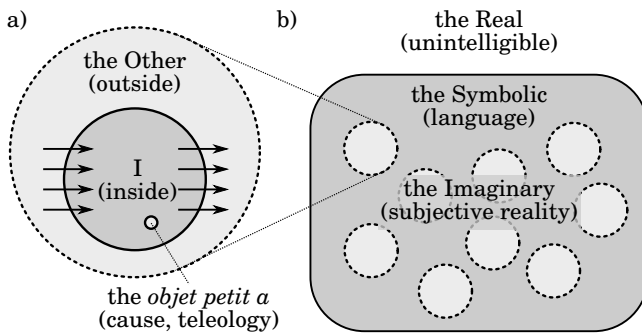

Fig. 1. The subject in Lacanian theory.

The subject is split. Structurally, the subject is divided into a part that holds beliefs about the world, and a part that governs the organisation and dynamics of those beliefs *in an automatic fashion*. The most well-known instantiation of this idea is the Freudian distinction between the *conscious* and the *unconscious*, where the latter constitutes psychological material that is repressed, but nevertheless accessible through dreams and involuntary manifestations such as a “slip of the tongue” (Freud, 1899). Here however, the interpretation that is more pertinent to our analysis is Lacan’s. In his terminology, the two aforementioned parts correspond to the *imaginary* and the *symbolic* registers respectively (Fig. 1b). Simply put, the imaginary can be described as the collection of concepts or images that, when pieced together, make up the totality of the subject’s ontology: in particular, the world and the subject’s sense of self. In other words, the imaginary register is responsible for entertaining hypotheses about reality. In turn, these images are organised by the symbolic register into a network of meaning that is pre-given, static, and “structured like a language” (Lacan, 1977).

¹It shall be noted however, that Lacan’s work is notoriously difficult to understand, partly due to the complexity and constant revisions of his ideas, but most importantly due to his dense, multi-layered, and obscure prose style. As a result, the interpretation presented here is based on my own reading of it, which was significantly influenced by Fink (1996), Mansfield (2000) and the work by Žižek (Žižek, 1992, 2009).

Language is a system of signification. Many of the modern ideas about knowledge and subjectivity are centred around language. In this view, the subject is seen as a signifying entity that produces and consumes signs (linguistic material) in the form of spoken language, images, and general sensorimotor expression (de Saussure, 1916). Language then can be thought of as a system of signs that operates by detecting signifiers (labels) and associating them to signifieds (meanings or ideas)—possibly in cascade, with the signifieds being the signifiers of later stages. Crucially, the associations between signifiers and signifieds are arbitrary and contingent, established by pure convention (think of ‘apple’, ‘manzana’, ‘mela’, ‘Apfel’, ‘pomme’, ‘תפוח’, etc.). The influence of these views is witnessed by the adoption of related ideas by thinkers from fields ranging from logic (Russell, 1905; Wittgenstein, 1921-1933), philosophy of language (Wittgenstein, 1953), phenomenology (Heidegger, 1927), rhetoric (Knape, 2000), and linguistics/cognitivism (Chomsky, 1957) to computer science (Turing, 1936–1937) and biology/cybernetics (Maturana, 1970; Maturana and Varela, 1987).

The real is the engine of the subject. The imaginary and the symbolic registers refer to the subject’s intellect, that is, to the organisation of the things that she can potentially comprehend or experience, and their structure is static. There is a third register in Lacan’s conceptualisation, namely the *real* (Fig. 1b), representing the unintelligible, random source of external perturbations that the subject picks up and integrates into her symbolic domain in the form of sense-data, thereby setting her knowledge in motion (compare *e.g.* to the “web of beliefs” of Quine (1951)).

Teleology. Finally, there is the question of purposeful behaviour. In Lacan, teleology (see Fig. 1a) is related to what he calls the *objet petit a*: that is, an unexpected incoherence that interrupts the otherwise regular chain of signification (Lacan, 1973; Žižek, 1992). Such an interruption has two consequences that are worth pointing out. First, the deviation from the regular chain of signification can be thought of as an expression of spontaneous desire, *i.e.* a sudden jerk that steers the chain into different, *preferred* consequences. Second, the interrupted signifying chain, by injecting randomness, introduces an independence of choice that entails a responsibility, a claim to ownership of cause, and a post-rationalisation of the subject’s decisions. In short: a detected irregularity signals *agency*. For instance, in the sequence

1, 2, 3, 4, 5, 6, 8, 9, 10,

the missing number 7 breaks the pattern and can give the impression that it was intentionally omitted.

III. SUBJECTIVITY IN BAYESIAN PROBABILITY THEORY

In the mathematical disciplines, one of the most prominent theories dealing with subjectivity is Bayesian probability theory. Its current formal incarnation came to be as a synthesis of many fields such as measure theory (see *e.g.* Lebesgue, 1902; Kolmogorov, 1933), set theory (Cantor, 1874), and logic (Frege, 1892; Russell, 1905; Wittgenstein, 1921-1933). After Bayes’ and Laplace’s initial epistemic usage of probabilities,

founders of modern probability theory have *explicitly* started using probabilities as degrees of subjective belief. On one hand, they have postulated that subjective probabilities can be inferred by observing actions that reflect personal beliefs (Ramsey, 1931; De Finetti, 1937; Savage, 1954); on the other hand, they regarded probabilities as extensions to logic under epistemic limitations (Cox, 1961; Jaynes and Bretthorst, 2003). Importantly, both accounts rely on a subject that does statistics in the world having belief updates governed by Bayes’ rule.

Bayesian probability theory, in its capacity as a subjectivist theory, can be related to ideas in Lacanian theory. Recall that formally, probability theory provides axiomatic foundations for modelling experiments² involving randomness. Such a *randomised experiment* takes the form of a probability space $(\Omega, \mathcal{F}, \mathbb{P})$, where Ω is a set of possible states of nature, \mathcal{F} is a σ -algebra on Ω (a collection of subsets of Ω that is closed under countably many set operations, comprising complement, union, and intersection), and \mathbb{P} is a probability measure over \mathcal{F} . Given this setup, I suggest the following correspondences, summarised in Tab. I:

- 1) *Real* \leftrightarrow *generative/true distribution*. In probability theory, it is assumed that there exists a source that secretly picks the state of Nature $\omega \in \Omega$ that is then progressively “revealed” through measurements. Some measure theory textbooks even allude to the irrational, unintelligible quality of the source³ by using the phrase “Tyche, the goddess of chance, picks a sample” to describe this choice (see for instance Billingsley, 1978; Williams, 1991).
- 2) *Symbolic* \leftrightarrow *probability space*. Conceptually, the σ -algebra \mathcal{F} of a probability space contains the universe of all the yes/no questions (*i.e.* propositions) that the subject can entertain. A particular aspect of a given state of Nature ω is extracted via a corresponding random variable $X : \Omega \rightarrow \mathcal{X}$, mapping ω into a symbol $X(\omega)$ from a set of symbols \mathcal{X} . Random variables can be combined to form complex aspects, and the ensuing symbols are consistent (*i.e.* free of contradictions) as guaranteed by construction. Thus, a probability space and the associated collection of random variables make up the structure of the potential realities that the subject can hope to comprehend. Furthermore, one can associate to each random variable at least one of three rôles (but typically just one), detailed next.
- 3) *Imaginary* \leftrightarrow *hypotheses*. A random variable can play the rôle of a *latent feature* of the state of Nature. Latent variables furnish the sensorimotor space with a conceptual or signifying structure, and a particular configuration of these variables constitutes a hypothesis in the Bayesian sense. Because of this function, we can associate the collection of latent variables to Lacan’s imaginary register.

²Here, I will use the word *experiment* in a very broad sense, including the thought processes of the subject throughout her entire life.

³Note that this allusion goes at least as far back as Hesiod’s *Theogony* dating from the pre-philosophical era. The *Theogony* describes the creation of the world by the *muses*—a literary device used at the time standing for something that is unintelligible.

- 4) *Flow between I and the Other* \leftrightarrow *actions & observations*. The hypotheses by themselves do not ground the subject’s symbolic domain to any reality however—for this, variables modelling interactions are required. These variables capture symbols that appear in the sensorimotor stream of the subject, that is, at her boundary with the world, modelling the directed symbolic flow occurring between the I and the Other; in particular, the out- and inward flows are represented by actions and observations respectively.
- 5) *Objet petit a* \leftrightarrow *causal intervention*. The last connection I would like to establish, which will become a central theme in what follows, is between the *objet petit a* and causal interventions. Lacanian theory explains agency in terms of a kink in the signifying chain—that is, the interruption of a pre-existing relation between two symbols—that is subjectivised *in hindsight* (Fink, 1996; Žižek, 1992). One crucial aspect of this notion is that it requires the comparison between two instants of the signifying network, namely the one where the relation is still intact and the resulting one where the relation is absent, adding a *dynamic* element to the static symbolic order. This element has *no* analogue in standard probability theory. However, the last twenty years have witnessed the systematic study of what appears to be an analogous idea in the context of probabilistic causality. More precisely, the interruption of the signifying chain is a causal intervention (Pearl, 2009).

TABLE I
LACANIAN AND BAYESIAN THEORIES OF THE SUBJECT.

Lacan		Bayes
real (register)	\longleftrightarrow	true distribution
symbolic (register)	\longleftrightarrow	probability space
imaginary (register)	\longleftrightarrow	hypotheses
the Other \rightarrow I (flow)	\longleftrightarrow	observations
I \rightarrow the Other (flow)	\longleftrightarrow	actions
<i>objet petit a</i>	\longleftrightarrow	causal intervention

One can establish a few more connections, for instance between Lacan’s concept of *jouissance* and the economic term *utility*, but I hope that the aforementioned ones suffice to make my case for now.

In summary, my claim is that Bayesian probability theory is almost an axiomatic subjectivist theory; “almost” because it lacks an analogue of the function performed by the *objet petit a*, namely causal interventions, which is crucial to fully characterise the subject. This will be the goal of the next section.

IV. CAUSALITY AND THE ABSTRACT SUBJECT

Thus, Bayesian probability theory can be taken as a mathematical theory of the subject that *passively* draws logical and probabilistic inferences from experience. To extend it to *interactive* subjects, *i.e.* subjects that can shape the course of realisation of a randomised experiment, it is necessary to

introduce additional formal machinery. Due to space limitations, the thorough analysis of these requirements is deferred to Appendix A, and the resulting synthesis into a measure-theoretic model of the interactive subject is presented in Appendix B. My goal here is to give an informal summary of the main ideas and results found therein.

A. Causality

Causality has always been one of the central aspects of human explanation, with its first philosophical discussion dating back to Aristotle’s *Physics* roughly some 2500 years ago. In spite of this, it has not received much attention from the scientific community, partly due to the strong scepticism expressed by Hume (1748) and later by prominent figures in statistics (Pearson et al., 1899) and logic (Russell, 1913). It is only in the recent decades that philosophers and computer scientists have attempted to characterise causal knowledge in a rigorous way (Suppes, 1970; Salmon, 1980; Rubin, 1974; Cartwright, 1983; Spirtes and Scheines, 2001; Pearl, 2009; Woodward, 2013; Shafer, 1996; Dawid, 2007). I refer the reader to Dawid (2010) for a mathematical, and Illari and Russo (2014) for a thorough philosophical comparison between existing approaches.

Arguably, one of the central contributions has been Pearl’s characterisation of causal interventions (Pearl, 1993, 2009), which in turn draws ideas from Simon (1977) and Spirtes and Scheines (2001). Informally, a causal intervention is conceived as a manipulation of the probability law of a random experiment that functions by holding the value of a chosen random variable fixed. The operation has been formalised in causal directed acyclic graphs (DAGs); structural models (Pearl, 2009); chain graphs (Lauritzen and Richardson, 2002); influence diagrams (Dawid, 2007) and decision problems (Dawid, 2015), to mention some. Another approach that is worth pointing out is that of Shafer (1996). Therein, Shafer shows that simple probability trees are able to capture very rich causal structures, although he does not define causal interventions on them. While the aforementioned definitions differ in their scope, interpretation, and degree of complexity, ultimately they entail transformations on probability measures that are mathematically consistent with each other.

B. Causality in Games with Imperfect Information

Interestingly though, one of the earliest and most general formalisations of what much later became known as causal interventions comes from game theory. More precisely, the characteristics underlying modern causal interventions feature implicitly in the representation of *extensive-form games with imperfect information* (Von Neumann and Morgenstern, 1944; Osborne and Rubinstein, 1999). This connection is straightforward but, rather surprisingly, rarely acknowledged in the literature. The game-theoretic *Ansatz* yields an elegant definition that can express a rich set of causal dependencies, including higher-order ones. Conceptually, the approach is similar to defining Pearl-type interventions on Shafer’s probability trees, and it lends itself to a measure-theoretic formalisation.

In this set-up, the subject interprets her experience as a sequential game between two players named *I* and *W* standing for the I and the Other (*i.e.* the World) respectively⁴—that is, player *I*’s moves are the subject’s actions, while *W*’s moves are the subject’s observations. The structure of the game embodies the causal narrative of the randomised experiment. Crucially, player *W*’s otherness is expressed by a special ability: it can play *secret moves* that *I* knows about but cannot see⁵. As a consequence, causal assumptions manifest themselves as independence relations that strictly limit player *I*’s knowledge about player *W*’s moves. The missing information has the effect of rendering some states in this game indistinguishable from each other in the eyes of player *I*⁶. In contrast, player *W* is omniscient, being able to see all the moves in the game.

To further clarify the peculiarities of this rather unusual set-up, it is helpful to make an analogy to dreams. In many of them, it is often the case that we encounter other people to whom we talk. These conversations can be vivid and—most importantly—surprising. Yet, how come we cannot anticipate what others will say, given that these dreams are entirely orchestrated by our own imagination? Somehow, our dreams go to great lengths to maintain this stable illusion of otherness of the people and the world by hiding their motives and reasons from us. That is, our imagination draws a demarcation line between the things done by ourselves (which do not surprise us) and the things done by others (which feel external and novel). To Lacan, this is no different when we are awake. The imaginary register is responsible for maintaining this illusion of the self and the world (players *I* and *W* respectively), and it does so within the confines of our language (*i.e.* the symbolic, providing the rules of the game).

From a syntactic point of view, perhaps the two most important findings of the analysis in Appendix A are that, firstly, an interactive subject must distinguish between her *actions* and *observations* because they entail different belief updates, and secondly, that in order to do so, the subject must differentiate between an *event* (*i.e.* a logical proposition about the experiment) and a *realisation* (*i.e.* a possible state of the experiment). I refer the reader to Appendix A for the details of this argument.

C. Representation of Causal Dependencies

To illustrate the set-up, consider the following classical example (with a twist), consisting of two random variables *W* and *B* representing the weather and the atmospheric pressure as measured by a mercury barometer. To simplify, assume that both *W* and *B* are binary, taking values in $\mathcal{W} = \{\text{sunny, rainy}\}$ and $\mathcal{B} = \{\text{low, high}\}$ respectively. From elementary physics, we know that the pairs (sunny, low) and (rainy, high) are more likely than (sunny, high) and (rainy, low).

Our subject (*e.g.* an extraterrestrial visitor) does not know whether the weather controls the barometer’s mercury column or the other way around. Using the language of causal

⁴Multiple “Others” are folded into a single player *W*.

⁵Game theory here subtly assumes that players have a theory of mind, that is to say, the presumption that other players possess private information or inaccessible “mental” states that direct their behaviour.

⁶In game-theoretic jargon, these states form so-called *information sets*.

DAGs, this situation can be represented as one where the subject ponders the plausibility of the two competing causal hypotheses, say $H = 1$ and $H = 2$, depicted in Fig. 2a, and the subject is challenged to *induce* one from experience. Crucially though, while each hypothesis can be represented as a separate graphical model, the causal dependencies governing the induction problem itself *cannot* be cast into a single causal DAG. Since the direction of the arc between W and B is unknown, the subject has to treat H as a latent variable that has to be inferred. Thus, we can tie the two hypotheses into a single diagram by adding a node for the latent variable as shown in Fig. 2b. However, the new diagram is *not* a causal DAG any more. Most importantly, the theory of causal DAGs does not specify how to do inference on this type of graph⁷ (Ortega, 2011).

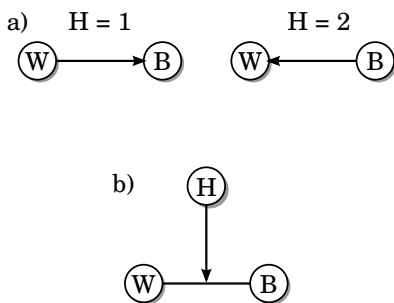

Fig. 2. Combination of causal hypotheses.

In contrast, this situation has a natural representation as a probability tree. This is because a probability tree allows specifying causal dependencies that are dynamically instantiated as a result of previous events. We first observe that the hypothesis H causally precedes the weather W and the height of the mercury column B , as H determines the very causal order of W and B . The resulting probability tree is depicted in Fig. 3. The semantics in a probability tree are self-explanatory: nodes represent the potential states of realisation of the random experiment, and the arrows indicate the possible transitions between them, which are taken with the probabilities indicated in the transition labels. Importantly, the arrows encode causal dependencies, in that they specify the order in which the intermediate states of the experiment are determined. Hence, a path starting at the root and ending in a leaf corresponds to a full realisation of the random experiment. The probability of a particular realisation (indicated by a bold number below the leaf) is obtained by multiplying the probabilities of all the transitions taken.

The probability tree in Fig. 3 also shows that the subject holds uniform prior beliefs $P(H) = 1/2$ over the two hypotheses as encoded by the two transitions at the root node. This inclusion of subjective probabilities is possible because we commit to a fully Bayesian interpretation of the probabilities in the tree. Finally, note that the left and right subtrees from the

⁷Note that this problem persists when using the language of *structural equations* (Pearl, 2009), as the hypothesis H controls whether to include either the structural equation $B = g(W, U)$ or $W = h(B, V)$ into the model, but at the same time, inferences are only defined once all the structural equations of the system are in place.

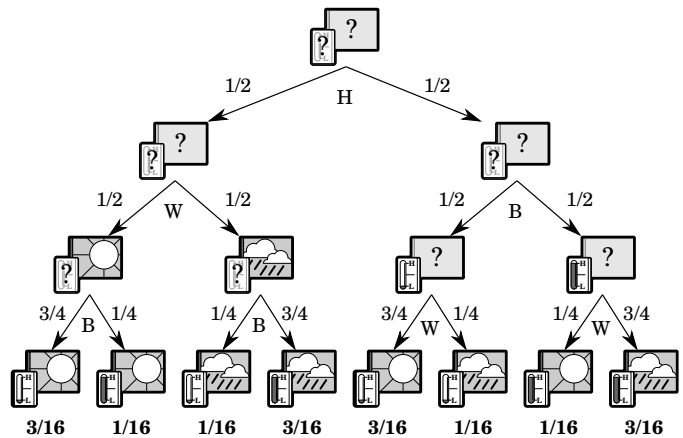

Fig. 3. Probability tree for the induction problem.

root node encode both a causal order and a likelihood function. In particular, the likelihood function $P(W, B|H)$ is identical for both causal hypotheses, and consequently there is no way to distinguish between them through purely observational data—that is, in a game where every single move is decided by player W .

Formally, a probability tree can be characterised through a *causal space* consisting of: a *sample space*; a collection of privileged nested events called the *set of realisations*; and a *causal probability measure* assigning transition probabilities (precise definitions are provided in Appendix B). Such a causal space contains enough information to generate the σ -algebra and the probability measure of a classical probability space. For instance, Fig. 4 illustrates a causal space suitable for modelling the probability tree of Fig. 3, where the states of realisation of the experiment have been labelled S_0, S_1, \dots, S_{15} .

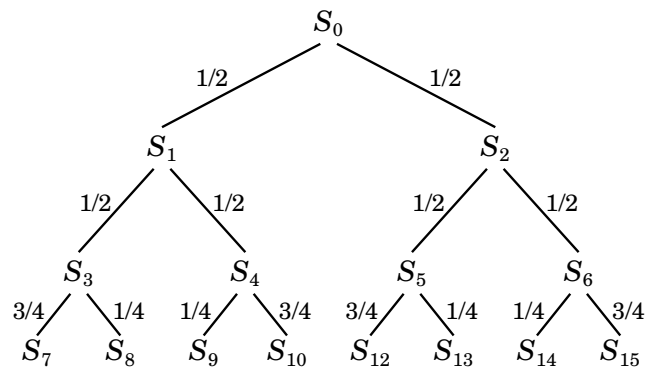

Fig. 4. Causal space of the induction problem.

D. Actions and Observations

As mentioned previously, actions and observations correspond to moves taken by players I and W respectively. During the course of the game, the subject keeps track of the probabilistic state of knowledge *as seen from the perspective of player I*. In particular, the moves of player I cannot depend on information that is private to player W .

a) *Observations*: First, suppose that the subject makes her first interaction by *observing* that the barometer's mercury column has fallen to a low value, *i.e.* $B = \text{low}$. This can happen under three possible moves by player W , namely $S_3 \rightarrow S_7$, $S_4 \rightarrow S_9$, and $S_2 \rightarrow S_5$. The observation allows the subject to rule out all the realisations of the experiment that take any of the incompatible transitions $S_3 \rightarrow S_8$, $S_4 \rightarrow S_{10}$ or $S_2 \rightarrow S_6$. Each one of the three compatible transitions postulates an alternative underlying state of the game. For instance, the move $S_3 \rightarrow S_7$ presumes that player W had secretly played the moves $S_0 \rightarrow S_1$ and $S_1 \rightarrow S_3$ before eventually revealing the last move to player I . However, since the latent state of the game is unknown to player I , the subject updates her beliefs by conditioning on $B = \text{low}$. Using Bayes' rule, the posterior probability of the causal hypothesis $H = 1$ is equal to

$$P(H = 1|B = \text{low}) = \frac{P(B = \text{low}|H = 1)P(H = 1)}{\sum_h P(B = \text{low}|H = h)P(H = h)} = \frac{1}{2},$$

where the likelihood $P(B = \text{low}|H = 1)$ is calculated by marginalising over the weather

$$\sum_w P(W = w|H = 1)P(B = \text{low}|H = 1, W = w) = \frac{1}{2},$$

and where $P(B = \text{low}|H = 2) = 1/2$ is as specified in the transition $S_2 \rightarrow S_5$. The posterior probability of the causal hypothesis $H = 2$ can then be obtained through the sum rule of probabilities:

$$P(H = 2|B = \text{low}) = 1 - P(H = 1|B = \text{low}) = \frac{1}{2}.$$

Since $P(H|B=\text{low}) = P(H)$, the observation of the barometer does not provide the subject with evidence favouring any of the two causal hypotheses.

b) *Actions*: Second, assume that the subject *acts* by setting the value $B = \text{low}$ herself instead. In this case, it is player I that makes one of the three aforementioned moves rather than player W . But, as is seen in Fig. 4, these moves possess different probabilities. In order to draw the action according to the prescribed odds, player I would have to know the underlying state of the game. Given that this is not the case, the subject must correct the probabilities of the randomised experiment before conditioning on $B = \text{low}$ to account for player I 's ignorance. Technically, this correction is done as follows:

- i. *Critical Bifurcations*. The subject identifies all the states of realisation having at least one transition leading to *any* compatible state and at least one transition leading *only* to incompatible states. These states are called *critical bifurcations*. In the case of setting $B = \text{low}$, the critical bifurcations are given by the states S_2 , S_3 , and S_4 .
- ii. *Transition Probabilities*. For each critical bifurcation, the subject assigns zero probability to every transition leading only to incompatible states, thereafter renormalising the remaining transitions. Fig. 5 shows the resulting causal space.

This operation is analogous to Pearl's notion of *causal intervention*, and the reader can find its mathematically rigorous definition in Appendix B. From a conceptual point of view

however, Pearl's motivation was to characterize the notion of *manipulation*, while here it arises as an accounting device for hiding information from player I .

After this correction has been made, a new causal probability measure $P_{B=\text{low}}$ is obtained, and the subject can condition her beliefs on $B = \text{low}$ as if it were a normal observation. Note that $P_{B=\text{low}}$ preserves all the transition probabilities of P save for the intervened ones.

Thus, the posterior probability of the causal hypothesis $H = 1$ given that player I set $B = \text{low}$ is equal to

$$P_{B=\text{low}}(H = 1|B = \text{low}) = \frac{P_{B=\text{low}}(B = \text{low}|H = 1)P_{B=\text{low}}(H = 1)}{\sum_h P_{B=\text{low}}(B = \text{low}|H = h)P_{B=\text{low}}(H = h)} = \frac{1}{2},$$

where, similarly to the observational case, the likelihood $P_{B=\text{low}}(B = \text{low}|H = 1)$ is calculated by marginalising over the weather, but now relative to the intervened distribution

$$\sum_w P_{B=\text{low}}(W = w|H = 1)P_{B=\text{low}}(B = \text{low}|H = 1, W = w) = 1,$$

and where the likelihood of the second hypothesis is

$$P_{B=\text{low}}(B = \text{low}|H = 2) = 1.$$

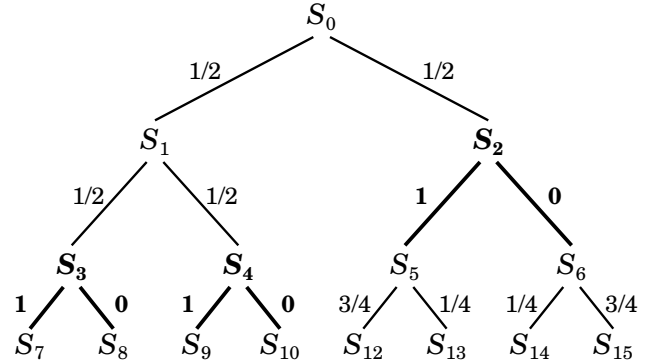

Fig. 5. Causal space after intervention.

Fig. 6 schematically illustrates the difference between the previous action and observation in terms of how the probability mass is adjusted during each belief update. Each rectangle illustrates the nested arrangement of the states of realisation (vertical axis) and their corresponding probability masses (horizontal axis). Belief updates are carried out in two steps: elimination of the incompatible probability mass and a subsequent renormalisation.

E. Posterior

We now conclude our example by calculating the posterior distribution over the two causal hypotheses. Note that both belief updates leave the posterior distribution unchanged, *i.e.*

$$P(H|B = \text{low}) = P_{B=\text{low}}(H|B = \text{low}) = P(H),$$

but they do so for different reasons: in the case of the observation, because the two causal hypotheses are observationally indistinguishable; and in the case of the action, because the choice of the hypothesis H precedes the barometer reading B .

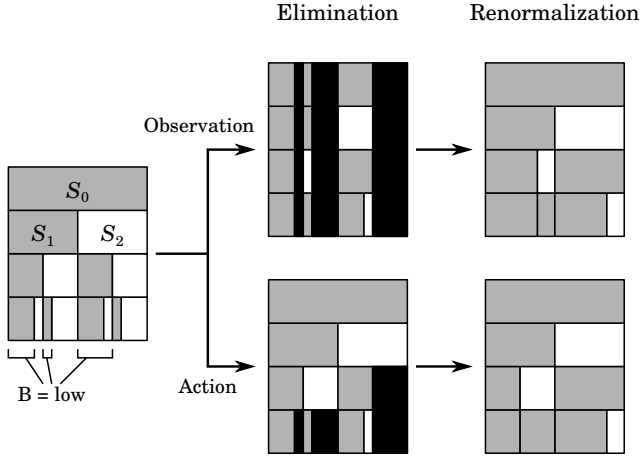

Fig. 6. Observations versus interventions.

Indeed, assume that the subject subsequently sees that the weather is rainy. Following an analogous calculation as before, it can be shown that

$$P(H = 1 | B = \text{low}, W = \text{rainy}) = \frac{1}{2},$$

for the purely observational case, and

$$P_{B=\text{low}}(H = 1 | B = \text{low}, W = \text{rainy}) = \frac{2}{3},$$

for the intervened case. Thus, the subject, by virtue of her action, can render the two causal hypotheses observationally distinguishable, entitling her to conclude that it is more likely that the weather controls the barometer just by looking at the weather. However, she does not rule out the alternative.

V. DISCUSSION

A. Causal Spaces

The model of the subject advocated here is in no way intended to be a replacement for existing causal frameworks. Rather, it aims at providing a common abstract ground containing a minimal set of primitives to reason about general causal interventions. This was achieved by supplying the σ -algebra of standard probability theory with a set of realisations encoding the causal dependencies governing its events.

The model detailed in Appendix B is limited to countable sets of realisations. This was chosen so as to ensure that the σ -algebras generated by realisation sets are always well defined (e.g. do not have excessive cardinalities). Furthermore, the axioms guarantee that causal interventions are always well defined for any given event.

B. Dynamic Instantiation of Causes

Causal spaces can express causal dependencies that are instantiated dynamically, that is to say, causes that only come into force under suitable higher-order causal conditions. Not only are these dynamic causes ubiquitous in Nature and society (e.g. genes that regulate the *relation* between other genes; smoking causing cancer leads governments to restrict tobacco; etc.), but also they are necessary to represent causal induction problems (see previous section).

C. Rôle of Interventions

To stress the importance of the function performed by causal interventions we can compare it to a mechanism found in the human immune system. The physical distinction between us and our surrounding seems obvious to us (e.g. we speak of our *body*) but from a biomolecular point of view it is far from clear where these boundaries are. Much to the contrary: these boundaries must be actively maintained by *antibodies*, which identify and sometimes neutralise *antigens* (i.e. foreign bodies, such as bacteria and viruses) for their subsequent removal by other parts of the immune system.

Similarly, causal interventions tag those events that are attributed to the subject's self to distinguish them from those generated by the world. Without them, the subject would be devoid of the psychological apparatus that gives her a sense of unity and agency, and she would experience her life as a "film with no recognizable protagonist" that she could identify herself with.

D. What is an Action?

Classical decision theory assumes from the outset that there is a clear-cut distinction between action and observation variables (Von Neumann and Morgenstern, 1944; Savage, 1954). Similarly, control theory and artificial intelligence take this distinction as a given. Indeed, artificial intelligence textbooks describe an agent as any system possessing sensors and effectors (Russell and Norvig, 2009).

In contrast, the idea of the subject as a construct plus the line of thought developed here suggest a different story. Whenever the subject sees an event as emanating from herself, she tags it through a causal intervention. However, every causal intervention changes her beliefs in an irreversible manner. For instance, consider the subject's choice probabilities of fixing the value of the barometer herself from the induction example. These were equal to

$$P(B = \text{low}) = \frac{1}{2} \quad \text{and} \quad P(B = \text{high}) = \frac{1}{2}$$

before the intervention, and

$$P_{B=\text{low}}(B = \text{low}) = 1 \quad \text{and} \quad P_{B=\text{low}}(B = \text{high}) = 0$$

immediately thereafter but *prior* to conditioning her beliefs on $B = \text{low}$. In other words, she went from being completely undecided to being absolutely convinced that this had been her choice all along⁸. Plus, the new probability measure $P_{B=\text{low}}$ does not possess enough information to recover the original probability measure P , yet it does contain the traces left by the intervention in the form of independences from the causal precedents. Accordingly, a random variable can be identified as an action if it can be thought of as the result of a causal intervention. But then again, how can she tell that the independences in $P_{B=\text{low}}$ were not already there from before the supposed intervention?

These observations raise the following basic open questions:

⁸Also, refer to the discussion in Appendix A-C.

- 1) What is the criterion employed by the subject to decide whether to treat an event as an action or an observation? To what extent is this arbitrary?
- 2) Does this criterion have to be learned in the form of an hypothesis in the Bayesian sense?
- 3) Does a subject gain anything from distinguishing between herself and the world?

Indeed, if the subject wanted to learn what her actions and observations are, then the only way she can classify a random variable unambiguously, as is the case in classical decision theory, is when she has no hypothesis offering a competing explanation.

This also sheds more light into the connection between causal interventions and Lacan's *objet petit a*⁹. An action turns out to be a random variable of somewhat contradictory nature: because on one hand, it is statistically independent and hence, subjectivised; but on the other hand, it is still generated by the external world, namely, by the very decision processes of the subject that are not under its direct control, *e.g.* following a utility-maximising agenda. Lacan's term *objet petit a* can thus be regarded as a play of words that encapsulates this dual nature (Fink, 1996).

E. Concluding Remarks

There are numerous reasons why I chose to compare Bayesian probability theory to Lacanian theory. It is true that, virtually since its inception, psychoanalytic theories have always faced fierce opposition that has questioned their status as a scientific discipline (see *e.g.* Popper, 1934; Feynman et al., 1964). While their efficacy as a treatment of mental illnesses is undoubtedly controversial (Tallis, 1996), cultural studies have embraced psychoanalytic theories as effective conceptual frameworks to structure the discourse about subjectivity in a metaphysically frugal fashion. As a researcher in artificial intelligence, the greatest value I see in the psychoanalytic theories is in that they epitomise the contingent cultural assumptions about subjectivity of modern Western thinking, summarising ideas that otherwise would require a prohibitive literature research.

Finally, I would like to stress that, while here my motivation was to advance a mathematical definition of subjectivity (in Bayesian terms), the resulting axiomatic system is agnostic about its interpretation. The reader can verify that many of the existing philosophical views are indeed compatible with the mathematical formalisation presented here (Illari and Russo, 2014), and that some of the philosophical interpretations are not unrelated to the psychoanalytic interpretation (*e.g.* the idea of *agency probabilities* put forward by Menzies and Price (1993) and the *epistemic* interpretation of causality of Williamson (2009)).

VI. ACKNOWLEDGEMENTS

The writing of this essay has benefited from numerous conversations with D.A. Braun, D. Balduzzi, J.R. Donoso,

A. Saulton, E. Wong and R. Nativio. Furthermore, I wish to thank the anonymous reviewers for their invaluable suggestions on how to improve this manuscript; M. Hutter and J.P. Cunningham for their comments on a previous version of the abstract model of causality (in my doctoral thesis); and A. Jori, Z. Domotor, and A.P. Dawid for their insightful lectures and discussions on ancient philosophy, philosophy of science and statistical causality at the Universities of Tübingen and Pennsylvania. This study was funded by the Ministerio de Planificación de Chile (MIDEPLAN); the Emmy Noether Grant BR 4164/1-1 (Computational and Biological Principles of Sensorimotor Learning); and by grants from the U.S. National Science Foundation, Office of Naval Research and Department of Transportation.

APPENDIX A PROBABILISTIC CAUSALITY

A. Evidential versus Generative Probabilities

One of the features of modern probability theory is that a probability space $(\Omega, \mathcal{F}, \mathbb{P})$ can be used in two ways, which we may label as *evidential* and *generative*. The evidential use conceives a probability space as a representation of an experimenter's knowledge about the conclusions he can draw when he is provided with measurements performed on the outcomes; while the generative usage sees the probability space as a faithful characterisation of the experiment's stochastic mechanisms that bring about observable quantities. Thus, a statistician or a philosopher can use probabilities to assess the *plausibility* of hypotheses, while an engineer or a physicist typically uses them to characterise the *propensity* of an event, often assuming that these propensities are objective, physical properties thereof.

In a Bayesian interpretation, evidential and generative refer to subject's observations/measurements and actions/choices respectively. Under the evidential usage of probabilities, the subject passively contemplates the measurements of phenomena generated by the world. A measurement reveals to the subject which possible worlds she can discard from her knowledge state. In contrast, under the generative usage of probabilities, the subject *is* the random process itself. Thus, outcomes are chosen randomly by the subject and then communicated to the world. While there are many cases where this distinction does not play a rôle, if we aim at characterising a subject that both passively observes and actively chooses, this distinction becomes crucial.

Our running example consists of a three-stage experiment involving two identical urns: urn A containing one white and three black balls, and urn B having three white and one black ball. In stage one, the two urns are either swapped or not with uniform probabilities. In stage two it is randomly decided whether to exclude the left or the right urn from the experiment. If the urns have not been swapped in the first stage, then the odds are 3/4 and 1/4 for keeping the left and the right urn respectively. If the urns have been swapped, then the odds are reversed. In the third and last stage, a ball is drawn from the urn with equal probabilities and its colour is revealed. We associate each stage with a binary random

⁹The term *objet petit a* loosely translates into "object little other". The "a" in *objet petit a* stands for the French word *autre* (other).

variable: namely $\text{Swap} \in \{\text{yes}, \text{no}\}$, $\text{Pick} \in \{\text{left}, \text{right}\}$ and $\text{Colour} \in \{\text{white}, \text{black}\}$ respectively. Figure 7 illustrates the set-up. In calculations, I will sometimes abbreviate variable names and their values with their first letters. We will now consider several interaction protocols between two players named I and W , representing the outward and inward flow of a subject respectively as detailed in Section III.

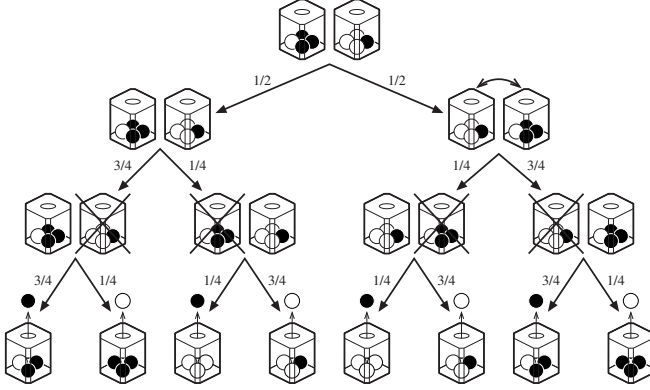

Fig. 7. A three-stage randomised experiment.

1) *Generative*: In the generative case, I carries out the three steps of the experiment, possibly consulting auxiliary randomising devices like tosses of fair coins. In each step, I makes a random *choice*; that is, it selects a value for the corresponding random variable following a prescribed probability law that depends on the previous choices. For instance, the odds of “drawing a black ball” given that “the urns have been swapped in the first stage and the right urn has been picked in the second stage” is $3/4$.

The probabilities governing I 's behaviour are formalised with a probability space $S := (\Omega, \mathcal{F}, P)$, where Ω_1 contains the eight possible outcomes, σ -algebra is the powerset $\mathcal{F} = \mathcal{P}(\Omega_1)$, and P is the probability measure that is consistent with the conditional probabilities in Figure 7. Table II lists the eight outcomes and their probabilities.

TABLE II
OUTCOME PROBABILITIES IN PROBABILITY SPACE S

Swap	Pick	Colour	Probability
no	left	black	9/32
no	left	white	3/32
no	right	black	1/32
no	right	white	3/32
yes	left	black	1/32
yes	left	white	3/32
yes	right	black	9/32
yes	right	white	3/32

The information contained in the probability space does not enforce a particular sequential plan to generate the outcome. The story of the experiment tells us that Swap, Pick, and Colour are chosen in this order. However, I can construct other sequential plans to generate the outcome. For example, I could first choose the value of Colour, then Swap, and finally Pick (possibly having to change the underlying story about urns and

balls), following probabilities that are in perfect accordance with the generative law specified by the probability space.

2) *Evidential*: In this case, player I , knowing about the probability law governing the experiment, passively observes its realisation as chosen by W . In each step, it makes a *measurement*; that is, I obtains the value of a random variable and uses it to update its beliefs about the state of the outcome. For instance, the plausibility of “the ball is black” given that “the urns have been swapped in the first stage and the right urn has been picked in the second stage” is $3/4$.

Here again, the probabilities governing I 's beliefs are formalised by the same probability space S . Analogously to the generative case, it does not matter in which order the information about the outcome is revealed to I : for instance, $P(\text{Colour}|\text{Swap}, \text{Pick})$ is the same no matter whether it observes the value of Swap or Pick first.

B. Mixing Generative and Evidential

Let us change the experimental paradigm. Instead of letting W choose and I passively observing, we now let both determine the outcome, taking turns in steering the course of the experiment depicted in Figure 7. In the first stage, W chooses between swapping the urns or not; in stage two, I decides randomly whether to keep the left or the right urn; and in the last stage, W draws a ball from the remaining urn. The protocol is summarised in Table III. We will investigate two experimental conditions.

TABLE III
PROTOCOL FOR THE EXPERIMENT

Stage	Variable	Chosen by
1	Swap	W
2	Pick	I
3	Colour	W

1) *Perfect Information*.: Under the first condition, both players are fully aware of all the previous choices. At any stage, the player-in-turn makes a decision following the conditional probability table that is consistent with past choices. It is easy to see that, again, the probability space S serves as a characterisation of the subject: although this time the conditional probabilities stand for I 's beliefs (first and last stage) and I 's behaviour (second stage). Essentially, the fact that we now have interactions between I and W can still be dealt with under the familiar analytical framework of probability theory. Note that, as in the previous two cases, we can suggest changes to the sequential order; furthermore, we can swap the players' rôles without changing our calculations.

2) *Imperfect Information*.: The second experimental regime is identical to the previous one with one exception: W carries out the first stage of the experiment secretly, *without telling* I whether the urns were swapped or not. Hence, for I , the statements “Swap = yes” and “Swap = no” are equiprobable (e.g. the urns are opaque, see Fig. 8). How should I choose in this case? Let us explore two attempts.

The first attempt consists in postulating that the two experimental regimes (perfect and imperfect information) are

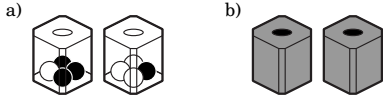

Fig. 8. Transparent versus opaque.

decoupled and hence require case-based probability specifications. Concretely, $P(\text{Pick}|\text{Swap} = \text{yes})$, $P(\text{Pick}|\text{Swap} = \text{no})$ and $P(\text{Pick})$ are unrelated probability distributions and are therefore freely specifiable. While this is a possible solution, it has the drawback that the resulting belief model violates the probability axioms, since in general the equation

$$P(P) \neq \sum_{S = y, n} P(P|S) P(S)$$

does not hold for tuples of conditional probability distributions.

The second attempt enlarges the model as follows. We add an auxiliary binary variable, say *KnowsSwap*, that indicates whether *I* is in possession of the value of variable *Swap*. This allows specifying a total of four conditional probability distributions of the form

$$P(\text{Pick}|\text{Swap}, \text{KnowsSwap})$$

indexed by the joint settings of *Swap* and *KnowsSwap*, where the latter can be treated as another random variable or as a conditional variable. However, this arrangement does not fundamentally bypass the original problem: we can extend *I*'s ignorance of the value of *Swap* to the value of *KnowsSwap* as well. That is, although we have extended *Pick*'s functional dependency from *Swap* to both *Swap* and *KnowsSwap*, *there is no reason why KnowsSwap should not be an undisclosed variable too*. Consequently, this would require introducing yet another auxiliary variable, say *KnowsKnowsSwap*, to indicate whether the value of *KnowsSwap* is known, and so forth, piling up an infinite tower of indicator variables. Eventually, one is left with the feeling that this second solution is conceptually unsatisfactory as well.

Thus, let us continue with a solution that accepts *I*'s ignorance of the value of the random variable *Swap*. The story of the experiment tells us that the probabilities $P(\text{Pick}|\text{Swap})$ have the semantics of conditional instructions for *I*; but since the condition is unknown, the choice probabilities consistent with this situation are obtained by marginalising over the unknown information. More specifically, the probability of picking the right urn is

$$P(P = r) = \sum_{S = y, n} P(P = r|S) P(S),$$

which is thereby rendered independent of the unknown information. For the particular numbers in our example, the choice probabilities evaluate to a uniform distribution

$$P(P = r) = \frac{3}{4} \cdot \frac{1}{2} + \frac{1}{4} \cdot \frac{1}{2} = \frac{1}{2}, \quad P(P = 1) = \frac{1}{2}.$$

Interestingly, the resulting experiment does not follow the same generative law as in the previous experimental condition any more, for the odds of swapping the urns in the first stage

and picking the right urn in the second were $\frac{1}{2} \cdot \frac{3}{4} = \frac{3}{8}$ and not $\frac{1}{2} \cdot \frac{1}{2} = \frac{1}{4}$ like in the current set-up. Thus, albeit *I*'s beliefs are captured by the probability space $S = (\Omega, \mathcal{F}, P)$, the outcomes of this new experiment follow a different generative law, described by a probability triple $S' := (\Omega, \mathcal{F}, P')$, where $P' \neq P$ is determined by the probabilities listed in Table IV. The choice made by *I* actually changed the probability law of the experiment!

TABLE IV
OUTCOME PROBABILITIES IN PROBABILITY SPACE S' .

Swap	Pick	Colour	Probability
no	left	black	3/16
no	left	white	1/16
no	right	black	1/16
no	right	white	3/16
yes	left	black	1/16
yes	left	white	3/16
yes	right	black	3/16
yes	right	white	1/16

A moment of thought reveals that this change happened simply because *I*'s state of knowledge did not conform to the functional requirements of the second random variable. At first seemingly harmless, this change of the probability law has far-reaching consequences for *I*'s state of knowledge: the familiar operation of probabilistic conditioning does not yield the correct belief update any more. To give a concrete example, recall that the plausibility of the urns having been swapped in the first stage *before I* picks the left urn in the second stage is

$$P(S = y) = \frac{1}{2}.$$

However, *after* the choice, the probability is

$$\begin{aligned} P(S = y|P = 1) &= \frac{P(P = 1|S = y)P(S = y)}{\sum_{S = y, n} P(P = 1|S)P(S)} \\ &= \frac{\frac{1}{4} \cdot \frac{1}{2}}{\frac{1}{4} \cdot \frac{1}{2} + \frac{3}{4} \cdot \frac{1}{2}} = \frac{1}{4}. \end{aligned}$$

Hence, if *I* wanted to use probabilistic conditioning to infer the plausibility of the hypothesis, then it would conclude that its choice actually *created evidence* regarding the first stage of the experiment—a conclusion that violates common sense.

C. Causal Realisations

If we accept that probabilistic conditioning is not the correct belief update in the context of generative probabilities then we need to re-examine the nature of probabilistic choices.

The familiar way of conceptualising the realisation of a random experiment (Ω, \mathcal{F}, P) is via the choice of a sample $\omega \in \Omega$ following the generative law specified by the probability measure P . Sequential observations are modelled as sequential refinements (*i.e.* a filtration)

$$\mathcal{F}_I \xrightarrow{S} \mathcal{F}_{II} \xrightarrow{P} \mathcal{F}_{III} \xrightarrow{C} \mathcal{F}$$

of an initial, ignorant algebra $\mathcal{F}_I = \{\Omega, \emptyset\}$ up to the most fine-grained algebra $\mathcal{F} = \mathcal{P}(\Omega)$. The labels on the arrows indicate

the particular random variable that has become observable (*i.e.* measurable) in the refinement. A second, non-standard way in the context of probability theory, is to think of a realisation as a *random transformation* of an initial probability triple (Ω, \mathcal{F}, P) into a final, degenerate probability triple $(\Omega, \mathcal{F}, P_\omega)$, where P_ω is the probability measure concentrating all its probability mass on the singleton $\{\omega\} \in \mathcal{F}$. This alternative way of accounting for random realisations will prove particularly fruitful to formalise probabilistic choices.

In many situations it is natural to subdivide the realisation of a complex experiment into a sequence of realisations of simple sub-experiments. For instance, the realisation of the experiment in the running example can be broken down into a succession of three random choices, *i.e.* a sequence

$$P \xrightarrow{f_S} P_I \xrightarrow{f_P} P_{II} \xrightarrow{f_C} P_{III},$$

of random transformations of the initial probability measure P . Here, the three mappings f_S , f_P , and f_C implement particular assignments for the values of Swap, Pick, and Colour respectively, and P_I , P_{II} , and P_{III} are their corresponding resulting probability measures. Together, f_S , f_P , and f_C form a *sequential plan* to specify a particular realisation $\{\omega\} \in \mathcal{F}$ of the experiment. However, the mathematical formalisation of such decompositions requires further analysis.

Underlying any purely evidential usage of probabilities, there is the implicit, although somewhat concealed, assumption of a predetermined outcome: the choice of the outcome of the experiment *precedes* the measurements performed on it¹⁰. In other words, obtaining information about the outcome updates the belief state of the subject, but not the outcome itself. In contrast, the generative use assumes an undetermined, fluid state of the outcome. More specifically, a choice updates both the beliefs of the subject *and the very state of the realisation*. Hence, there are two types of states that have to be distinguished: the state of the beliefs and the state of the realisation.

Distinguishing between the states of the realisation imposes restrictions on how beliefs have to be updated after making choices. These restrictions are probably best highlighted if one imagines—just for illustrative purposes—that the experiment is a physical system made up from a cascade of (stochastic) mechanisms, where each mechanism is a sub-experiment implementing a choice. Based on the physical metaphor, one concludes that choices can only affect the odds of the states of realisation that are *downstream*. So, for instance, picking the left urn knowing that the urns were swapped in the first stage increases the odds for drawing a white ball in the last stage, but it cannot change the fact that the urns have been swapped. Hence, the belief update following a choice affects the beliefs about the future, but not about the past¹¹.

Another aspect of choices is concerned with their scope, which spans many potential realisations. Consider the second stage of the experiment. As it can be seen from its illustration

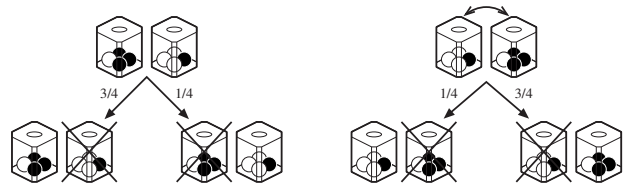

Fig. 9. The second stage of the randomised experiment.

in Figure 9, this stage contains two parts, namely one for each possible outcome of the first stage. In a sense, its two constituents could be conceived as being actually two stand-alone experiments deserving to be treated separately, since they represent alternative, mutually exclusive historical evolutions of the sequential experiment which were rendered causally independent by the choice in the first stage. Thus, picking an urn given that the urns were swapped in the first stage could in principle have nothing to do with picking an urn given that the urns were not swapped. However, this separation requires knowing the choices in the execution of the sequential experiment; a situation that failed to happen in our previous example. To be more precise: the semantics of this grouping is precisely that we have declared not being able to discern between them. In game theory, this is called an *information set*—see Appendix A-D later in the text.

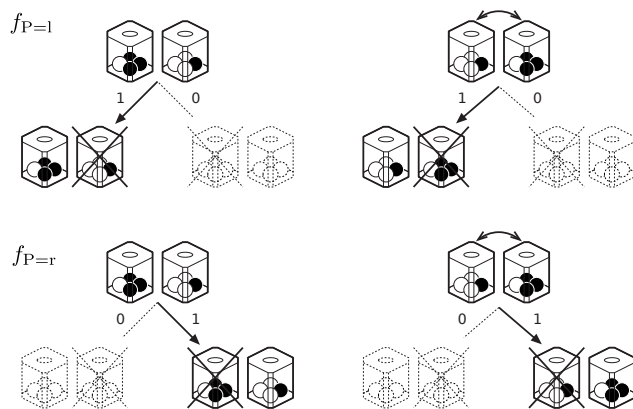

Fig. 10. The two possible choices in the second stage.

Even though it is clear that the belief update for a choice has to respect the causal boundaries separating the different histories, a choice is an epistemic operation that affects *all* histories in parallel because they are the *same* from the subject's point of view. Therefore, we formalise the sub-experiment in Figure 9 as a *collection* of experiments admitting two choices, namely $f_{P=1}$ and $f_{P=r}$, representing the choice of the left and right urn respectively. Suppose we are asked to choose the left urn in this collection of experiments. This makes sense because “choosing the left urn” is an operation that is well-defined across all the members in the collection. Then, this choice amounts to a transformation that puts all the probability mass on both left urns. Analogously, “choosing the right urn” puts all the probability mass on the right urns. The two choices, $f_{P=1}$ and $f_{P=r}$, are illustrated in Figure 10.

¹⁰Here we recall the probabilistic mythology, in which it is *Tyche, the Goddess of Chance*, who has the privilege of choosing the outcome.

¹¹To be more precise, by the terms *past* and *future* I mean the causal precedents and causal successors respectively.

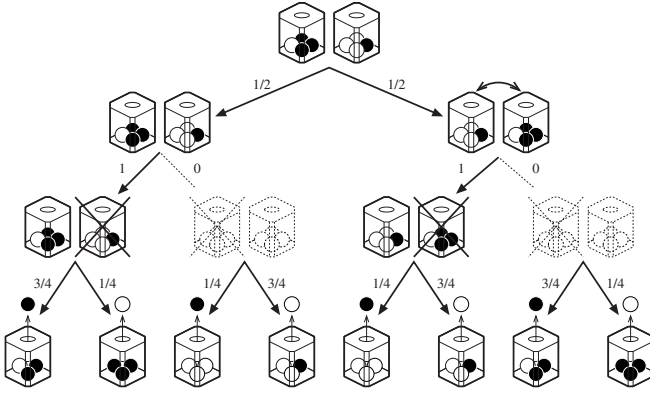

Fig. 11. The three-stage randomised experiment after choosing the left urn in the second stage.

Recall the situation where player I chose the left urn without knowing whether the urns were swapped or not in the first stage. From our previous discussion, this amounts to applying $f_{P=1}$ to the sub-experiment in the second stage. This leads to the modified three-stage experiment illustrated in Figure 11 having a probability measure $P_{P=1}$, where the subscript informs us of the manipulation performed on the original measure P . Similarly, if $f_{P=r}$ is applied, we obtain the probability measure $P_{P=r}$ for the experiment. Table V lists both probability measures plus the expected probability measure $E[P_P]$ which averages over the two choices. Notice that in Table IV, it is seen that $E[P_P]$ is equal to P' , *i.e.* the probability law resulting from the experiment under the condition of imperfect information.

TABLE V
PROBABILITIES OF THE EXPERIMENT AFTER THE CHOICE OF PICK.

Swap	Pick	Colour	$P_{P=L}$	$P_{P=R}$	$E[P_P]$
no	left	black	3/8	0	3/16
no	left	white	1/8	0	1/16
no	right	black	0	1/8	1/16
no	right	white	0	3/8	3/16
yes	left	black	1/8	0	1/16
yes	left	white	3/8	0	3/16
yes	right	black	0	3/8	3/16
yes	right	white	0	1/8	1/16

Finally, we calculate the plausibility of the urns having been swapped after the left urn is chosen. This is given by

$$\begin{aligned}
 P_{P=1}(S = y|P = 1) &= \frac{P_{P=1}(P = 1|S = y)P_{P=1}(S = y)}{\sum_{s=y,n} P_{P=1}(P = 1|S = s)P_{P=1}(S = s)} \\
 &= \frac{1 \cdot P(S = y)}{\sum_{s=y,n} 1 \cdot P(S = s)} \\
 &= \frac{1 \cdot \frac{1}{2}}{1 \cdot \frac{1}{2} + 1 \cdot \frac{1}{2}} = \frac{1}{2}.
 \end{aligned}$$

Hence, according to the belief update for choices that we have proposed in this section, choosing the left urn in the second stage does not provide evidence about the first stage. However, if a black ball is drawn right afterwards, the posterior

plausibility will be

$$\begin{aligned}
 P_{P=1}(S = y|P = 1, C = b) &= \frac{P_{P=1}(C = b|S = y, P = 1)P_{P=1}(S = y|P = 1)}{\sum_{s=y,n} P_{P=1}(C = b|S = s, P = 1)P_{P=1}(S = s|P = 1)} \\
 &= \frac{\frac{1}{4} \cdot \frac{1}{2}}{\frac{1}{4} \cdot \frac{1}{2} + \frac{3}{4} \cdot \frac{1}{2}} = \frac{1}{4},
 \end{aligned}$$

i.e. the subject obtains evidence favouring the hypothesis that the urns were not swapped. This leads to an interesting interpretation. In a sense, the intervention functions as a psychological mechanism informing the subject that her choice cannot be used as additional evidence to support hypotheses about the past; the fundamental rôle of the intervention is to declare the choice as an unequivocal, deterministic consequence of the subject's state of knowledge at the moment of the decision. Or, loosely speaking, the intervention “tricks the subject into believing that her choice was deliberate, not originating from an external source”—recall the discussion about the *objet petit a*. As a consequence, a subject can never learn from her own actions; rather, she only learns from their effects.

D. Connection to Extensive-Form Games

Before concluding this section, we briefly review the relation between the causal interventions derived above and their connection to extensive-form games. For the sake of brevity, here I will adopt an informal exposition to elucidate the connection of concern, referring the reader to the original text by Von Neumann and Morgenstern (1944, ch. 7) or the modern text by Osborne and Rubinstein (1999, chs. 2, 6, and 11) for a formal description.

In game theory, an *extensive-form game* is a specification of a game between two or more players that can capture a variety of aspects of the game mechanics, such as the order and possible moves of the players, the information available to them under each situation, their pay-offs, and chance moves. The representation of such a game consists in a rooted game tree, where each node is assigned to a player, and where the edges leaving a node represent the possible moves that the corresponding player can take in that node.

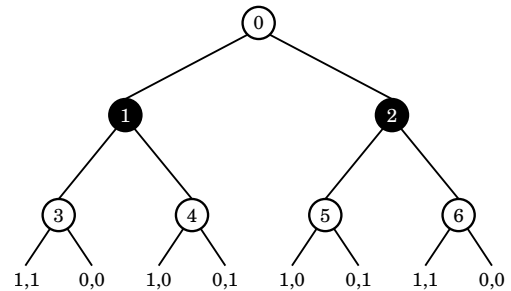

Fig. 12. An extensive-form game with perfect information.

Fig. 12 illustrates a two-player game with three steps. The internal nodes are coloured according to the player that takes that move, and each terminal node is labelled with the pay-off

for Black and White respectively. Here, notice that the best strategy for Black consists in choosing *left* when in node 1, and *right* when in node 2, as otherwise she would walk away empty-handed, assuming that White makes moves to maximise his own pay-offs.

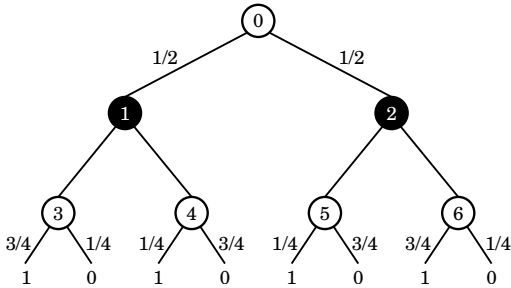

Fig. 13. Replacing one player with chance moves.

We can bring chance elements into the game by replacing one of the players with stochastic moves. In this case, White is substituted with a stochastic strategy that is reminiscent of the original optimal strategy (*i.e.* White now chooses a suboptimal move with probability $1/4$), like shown in Fig. 13. Notice that once the strategy is settled, we can drop the pay-offs for White from the description of the game. The new game with chance moves for White has the same optimal strategy for Black as the previous game.

The two previous games are known as games with *perfect information*, because players know at all times what moves were taken previously in the game. To model games where players do not see one or more of the previous moves, von Neumann introduced the concept of an *information set*. An information set consists of a set of nodes belonging to the same player, with the semantics that if any of them is reached during the game, then the corresponding player cannot distinguish between its members to make the next move. Hence, the general description of an extensive-form game requires specifying an partition of each player's decision nodes into information sets, and perfect information games are special in that each player's partition is just a collection of singletons.

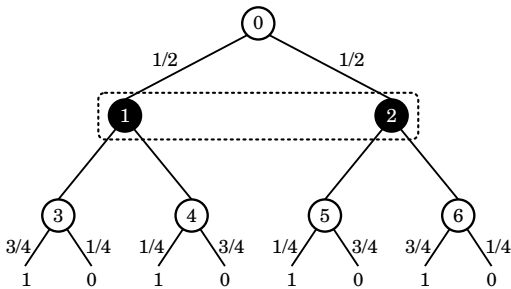

Fig. 14. Information sets.

Information sets are typically drawn as a loop around its member nodes, and singleton sets are omitted for brevity. Fig. 14 shows the new game obtained from lumping together nodes 1 & 2. As a result, the previous optimal strategy for

Black is not valid any more, since it prescribes different moves for the two nodes in the set. In contrast, the new optimal strategy for Black must take into account that either node is reached with the same probability. Indeed, under this constraint on Black's knowledge, it is easily seen that both possible actions are rendered equally good.

It hard to overstate Von Neumann's achievement. Clearly, information sets play the rôle of restricting the game dynamics under causal constraints, *i.e. players' moves are interventions*. More precisely, once players pick their strategies, the resulting sequential distribution over moves can be thought of as the result of applying the type of causal interventions discussed in the preceding parts of this section (see Fig. 15 for a comparison with the associated causal DAG).

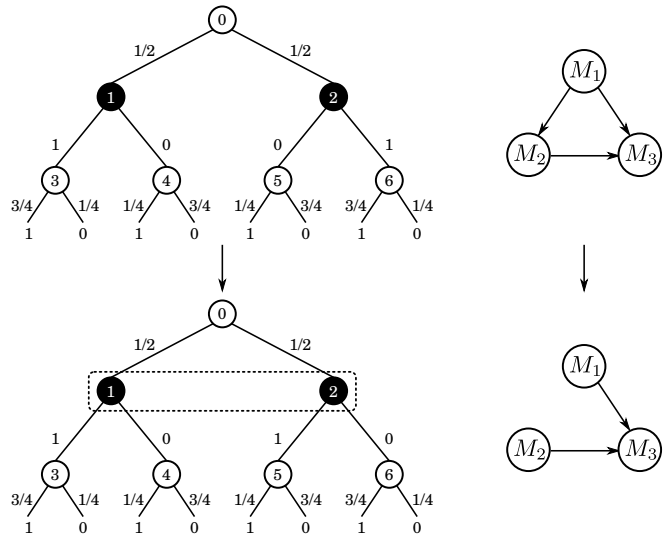

Fig. 15. The causal intervention is highlighted when comparing the game dynamics before and after introducing the information sets of Black.

APPENDIX B THE ABSTRACT SUBJECT

The aim of this section is to present an abstract model of the subject. In particular, I have dedicated much effort into elucidating the links to measure-theoretic probability, which currently holds the status of providing the standard foundations for abstract probability theory.

A. Realisations and Causal Spaces

First we introduce a structure that models the states of realisation of a random experiment.

Definition 1 (Realisation). A set \mathcal{R} of non-empty subsets of Ω is called a *set of realisations* iff

R1. *the sure event is a realisation:*

$$\Omega \in \mathcal{R};$$

R2. *realisations form a tree:*

$$\text{for each distinct } U, V \in \mathcal{R}, \text{ either } U \cap V = \emptyset \text{ or } U \subset V \text{ or } V \subset U;$$

R3. *the tree is complete:*

for each $U, V \in \mathcal{R}$ where $V \subset U$, there exists a sequence $(V_n)_{n \in \mathbb{N}}$ in \mathcal{R} such that $U \setminus V = \bigcup_n V_n$.

R4. *every branch has a starting and an end point:*

let $(V_n)_{n \in \mathbb{N}} \in \mathcal{R}$ be such that $V_n \uparrow V$ or $V_n \downarrow V$. Then, $V \in \mathcal{R}$.

A member $U \in \mathcal{R}$ is called a *realisation* or a *realisable event*. Given two realisations $U, V \in \mathcal{R}$, we say that U *precedes* V iff $U \supset V$. Given two subsets $\mathcal{U}, \mathcal{V} \subset \mathcal{R}$, we say that \mathcal{U} *precedes* \mathcal{V} iff for every $V \in \mathcal{V}$, there exists an element $U \in \mathcal{U}$ such that U precedes V . Analogously, we also say that V *follows* U iff U precedes V , and that \mathcal{V} *follows* \mathcal{U} iff \mathcal{U} precedes \mathcal{V} . Finally, two realisations $U, V \in \mathcal{R}$ that neither precede nor follow each other are said to be *incomparable*.

From axioms R1–R3, it is clearly seen that a set of realisations is essentially a tree of nested subsets of the sample space, rooted at the sample space. Axiom R4 includes the upper and lower limits of realisation sequences, thus constituting a formalisation of the fourth postulate causal reasoning. One important difference to standard σ -algebras is that the complement is, in general, *not* in the algebra, the only exception being the impossible realisation.

An immediate consequence of this definition is that the set of realisations forms a partial order among its members. The partial order is the fundamental requirement for modelling causal dependencies.

Proposition 2. [Partial Order] *A set of realisations \mathcal{R} endowed with the set inclusion \subset forms a partial order.*

Proof: Trivial, because it is inherited from $(\mathcal{P}(\Omega), \subset)$: it is reflexive, since for each $U \in \mathcal{R}$, $U \subset U$; it is antisymmetric, since for each $U, V \in \mathcal{R}$, if $U \subset V$ and $V \subset U$ then $U = V$; and it is transitive, because for all $U, V, W \in \mathcal{R}$, if $W \subset V$ and $V \subset U$ then $W \subset U$. ■

The intuition here is that “ $U \supset V$ ” corresponds to the intuitive notion of “ V depends causally on U ”, *i.e.* the veracity of V can only be determined insofar U is known to have obtained; and “ $U \cap V = \emptyset$ ” means that “ V and U are causally independent”.

A set of realisations can be visualised as a tree of nested sets. For instance, Fig. 16 is a possible set of realisations for the experiment in Fig. 7. Here, the sure event Ω at the root is partitioned recursively into branches until reaching the leaves representing the termination of the experiment.

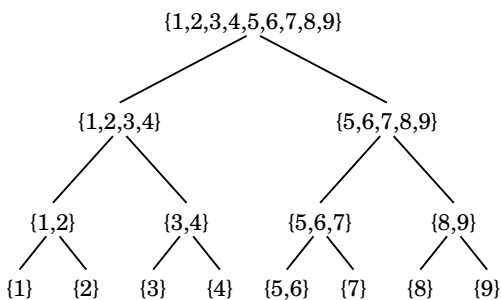

Fig. 16. A realisation set for the experiment.

Next we define an important class of events of the experiment, namely those that can be thought of as a union of causal histories that are potentially incompatible.

Definition 3 (Representation). A subset $A \subset \Omega$ is said to have a *representation* in \mathcal{R} iff there exists a sequence $(A_n)_{n \in \mathbb{N}}$ in \mathcal{R} such that $\bigcup_n A_n = A$. The *set of representable events* $r(\mathcal{R})$ is the collection of all the subsets of Ω that have a representation in \mathcal{R} .

For instance, consider the subsets

$$A_1 = \{2, 5, 6\}, \quad A_2 = \{3, 4\} \quad \text{and} \quad A_3 = \{4, 5\}.$$

A_1 has a unique representation given by $A_1 = \{\{2\}, \{5, 6\}\}$; A_2 has two representations, namely $A_2 = \{\{3\}, \{4\}\}$ and $A_2' = \{\{3, 4\}\}$; and A_3 does not have a representation.

It turns out that the set of representable events has a fundamental property: it coincides with the σ -algebra generated by \mathcal{R} . This means that every event of the experiment can be thought of as corresponding to a collection of possibly mutually exclusive realisations.

Theorem 4 (Representation). *Let \mathcal{R} be a set of realisations, let $r(\mathcal{R})$ be the set of representable events in \mathcal{R} and let $\sigma(\mathcal{R})$ be the σ -algebra generated by \mathcal{R} . Then, $r(\mathcal{R}) = \sigma(\mathcal{R})$.*

Proof: *Case $r(\mathcal{R}) \subset \sigma(\mathcal{R})$:* This follows directly from the definition of a σ -algebra. *Case $r(\mathcal{R}) \supset \sigma(\mathcal{R})$:* We prove this by induction. For the base case, let $(V_n)_{n \in \mathbb{N}}$ be a sequence in \mathcal{R} . Then, $V = \bigcup_n V_n \in \sigma(\mathcal{R})$ has a representation in \mathcal{R} . Furthermore, $V \in \mathcal{R}$ implies that there exists $(V_n)_{n \in \mathbb{N}}$ in \mathcal{R} such that $\Omega \setminus V = \bigcup_n V_n$ (Axiom R3). Hence, $V^c \in \sigma(\mathcal{R})$ too has a representation in \mathcal{R} . For the induction case, assume we have a sequence $(A_n)_{n \in \mathbb{N}}$ with representations $(\mathcal{A}_n)_{n \in \mathbb{N}}$ respectively, where $\mathcal{A}_n = (V_{n,m})_{m \in \mathbb{N}}$ for each $n \in \mathbb{N}$. Then,

$$\bigcup_n A_n = \bigcup_n \bigcup_m V_{n,m} = \bigcup_l V_l,$$

where $l \in \mathbb{N}$ is a diagonal enumeration of the $(n, m) \in \mathbb{N} \times \mathbb{N}$. Obviously, $(V_l)_{l \in \mathbb{N}}$ is a representation for $\bigcup_n A_n \in \sigma(\mathcal{R})$. Now, assume that $A \in \sigma(\mathcal{A})$ has a representation $(A_n)_{n \in \mathbb{N}}$. Then,

$$A^c = \left(\bigcup_n A_n \right)^c = \bigcap_n A_n^c.$$

Since the A_n are in \mathcal{R} , their complements A_n^c have representations $(V_{n,m})_{m \in \mathbb{N}}$. Hence,

$$A^c = \bigcap_n A_n^c = \bigcap_n \bigcup_m V_{n,m} = \bigcup_{f: \mathbb{N} \rightarrow \mathbb{N}} \bigcap_n V_{n,f(n)},$$

where the last equality holds due to the extensionality property of sets. More specifically, for $\omega \in \Omega$ to be a member of the l.h.s., there must be an m for each n such that $\omega \in V_{n,m}$. This is true in particular for the map f that chooses the smallest m for each n . Hence, ω is a member of the r.h.s. Now, consider an element $\omega \in \Omega$ that is not in the l.h.s. Then, there exists some n such that $\omega \notin V_{n,m}$ for all m . Since, for this particular n , this is false for any choice of f in the r.h.s., ω is not a member of the r.h.s., which proves the equality. Finally, since intersections of members $V_{n,m}$ of \mathcal{R} are either equal to \emptyset or

equal to a member V_l of \mathcal{R} (Axiom R2), one has $A^c = \bigcup_l V_l$ for some $(V_l)_{l \in \mathbb{N}}$, which is a representation of A^c . ■

Having defined the basic structure of realisations, we now place probabilities on them. However, rather than working with the standard (unconditional) probability measure P that is customary in measure-theory, here—as is also the case in Bayesian probability theory (Cox, 1961; Jaynes and Bretthorst, 2003)—it is much more natural to work directly with a conditional probability measure $P(\cdot|\cdot)$. One way to establish the connection to the standard measure-theoretic view consists in thinking of the conditional probability measure as a function such that $P(A|\Omega) := P(A)$ and $P(A|U) := P(A \cap U)/P(U)$ whenever $U \in \mathcal{R}$ is such that $P(U) > 0$. Henceforth, we will drop the qualifier “conditional”, and just talk about the “probability measure” $P(\cdot)$.

Definition 5 (Causal Measure). Given a set of realisations \mathcal{R} , a *causal measure* is a binary set function $P(\cdot|\cdot) : \mathcal{R} \times \mathcal{R} \rightarrow [0, 1]$, such that

C1. *the past is certain:*

For any $V, U \in \mathcal{R}$, if U precedes V , then

$$P(U|V) = 1;$$

C2. *incomparable realisations are impossible:*

For any incomparable $V, U \in \mathcal{R}$,

$$P(V|U) = 0;$$

C3. *sum-rule:*

For any $U \in \mathcal{R}$ and any disjoint sequence $(V_n)_{n \in \mathbb{N}}$ such that V_n follows U for all $n \in \mathbb{N}$ and $\bigcup_{n \in \mathbb{N}} V_n = U$,

$$\sum_{n \in \mathbb{N}} P(V_n|U) = 1;$$

C4. *product-rule:*

For any $U, V, W \in \mathcal{R}$ such that W follows V and V follows U ,

$$P(W|U) = P(W|V) \cdot P(V|U).$$

Thus, a causal measure is defined only over $\mathcal{R} \times \mathcal{R}$, providing a supporting skeleton for the construction of a full-fledged probability measure extending over the entire σ -algebra. A simple way of visually representing a causal measure is by indicating the transition probabilities in the corresponding tree diagram, as illustrated in Fig. 17. In the figure, the sets have been replaced with labels, e.g. $S_0 = \Omega$ and $S_4 = \{3, 4\}$.

Definition 6 (Compatible Probability Measure). Given a causal measure P over a set of realisations \mathcal{R} , a probability measure $P'(\cdot|\cdot) : \sigma(\mathcal{R}) \times \sigma(\mathcal{R}) \rightarrow [0, 1]$ is said to be *compatible* with P iff $P' = P$ on $\mathcal{R} \times \mathcal{R}$.

It turns out that the causal measure almost completely determines its compatible probability measures, the exception being the probabilities conditioned on events that are not realisations. To show this, we first introduce a definition.

Definition 7 (\mathcal{R}_U, Σ_U). Let \mathcal{R} be a set of realisations. For any given U , define $\mathcal{R}_U := U \cap \mathcal{R}$ and $\Sigma_U := U \cap \sigma(\mathcal{R})$.

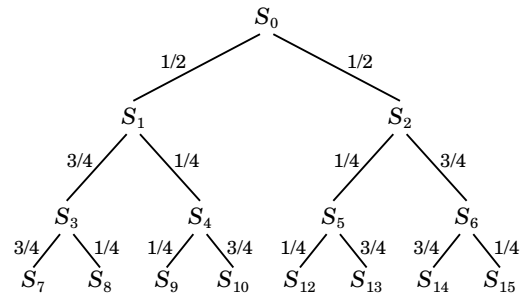

Fig. 17. A causal space for the experiment.

Observe that \mathcal{R}_U is a set of realisations based on U as the sample space. Furthermore, it is well-known (Ash and Doléans-Dade, 1999, Chapter 1.2) that

$$\Sigma_U = U \cap \sigma(\mathcal{R}) = \sigma_U(U \cap \mathcal{R})$$

where $\sigma_U(U \cap \mathcal{R})$ is the σ -algebra generated by subsets of U , i.e. where U rather than Ω is taken as the sample space. The aforementioned uniqueness result follows.

Proposition 8. Let P_1 and P_2 be two probability measures that are compatible with a causal measure P over \mathcal{R} . Then, for each $U \in \mathcal{R}$, $V \in \Sigma_U$, $P_1(V|U) = P_2(V|U)$.

Proof: First we note that each \mathcal{R}_U is a π -system, i.e. a family of subsets of U that is stable under finite intersection: $U, V \in \mathcal{R}_U$ implies $U \cap V \in \mathcal{R}_U$. This is because, for any $U \in \mathcal{R}_U$, $U \cap U \in \mathcal{R}_U$; and for all distinct $U, V \in \mathcal{R}_U$, either $U \cap V = \emptyset$ or $U \subset V$ or $V \subset U$ implies that either $U \cap V = \emptyset = U \setminus U$ or $U \cap V = U$ or $V \cap U = V$, which are all members of \mathcal{R}_U .

Next we prove that for each $U \in \mathcal{R}$, $V \in \Sigma_U$, $P_1(V|U) = P_2(V|U)$. Lemma 1.6. in Williams (1991) states that, if two probability measures agree on a π -system, then they also agree on the σ -algebra generated by the π -system. Pick any $U \in \mathcal{R}$. Applying the lemma, we conclude that for all $V \in \Sigma_U$, $P_1(V|U) = P_2(V|U)$. Since $U \in \mathcal{R}$ is arbitrary, the statement of the proposition is proven. ■

Given the previous definition, we are ready to define our main object: the causal space. A causal space, like a standard probability space, serves the purpose of characterising a random experiment, but with the important difference that it also contains information about the causal dependencies among the events of the experiment.

Definition 9 (Causal Space). A *causal space* is a tuple $C = (\Omega, \mathcal{R}, P)$, where Ω is a set of outcomes, \mathcal{R} is a set of realisations on Ω , and P is a causal measure over \mathcal{R} .

Intuitively, it is clear that a causal space contains enough information to characterise probability spaces that represent the same experiment. These probability spaces are defined as follows.

Definition 10 (Compatible Probability Space). Given a causal space $C = (\Omega, \mathcal{R}, P)$, a probability space $S = (\Omega, \mathcal{F}, P')$ is said to be compatible with C if $\mathcal{F} = \sigma(\mathcal{R})$ and P' is compatible with P .

An immediate consequence of the previous results is that compatible probability spaces are essentially unique.

Corollary 11. *Let $S_1 = (\Omega, \mathcal{F}_1, P_1)$ and $S_2 = (\Omega, \mathcal{F}_2, P_2)$ be two probability spaces compatible with a given causal space $C = (\Omega, \mathcal{R}, P)$. Then,*

- 1) *their σ -algebras are equal, i.e. $\mathcal{F}_1 = \mathcal{F}_2$;*
- 2) *and their probability measures are equal on any condition $U \in \mathcal{R}$ and σ -algebras Σ_U , i.e. for any $U \in \mathcal{R}$, $V \in \Sigma_U$, $P_1(V|U) = P_2(V|U)$.*

Importantly though, one cannot derive a unique causal space from a probability space; that is to say, given a probability space, there is in general more than one causal space that can give rise to it. Crucially, these causal spaces can differ in the causal dependencies they enforce on the events of the experiment, thus representing incompatible causal realisations.

B. Causal Interventions

The additional causal information contained in causal spaces serve the purpose of characterising cause-effect relations (e.g. functional dependencies) and the effects of interventions of a random experiment. Interventions modify realisation processes in order to steer the outcome of a random experiment into a desired direction.

We begin this subsection with the formalisation of a sub-process as a sequence of realisations of the experiment, that is, as a realisation *interval*.

Definition 12 (Interval). Let $U, V \in \mathcal{R}$. Define

$$\mathcal{I} := \{W \in \mathcal{R} : U \supset W \text{ and } W \supset V\}.$$

Then, based on \mathcal{I} , define:

$$\begin{aligned} [U, V]_{\mathcal{R}} &:= \mathcal{I}, && \text{(closed interval)} \\ (U, V]_{\mathcal{R}} &:= \mathcal{I} \setminus \{U\}, && \text{(right-closed interval)} \\ [U, V)_{\mathcal{R}} &:= \mathcal{I} \setminus \{V\}, && \text{(left-closed interval)} \\ (U, V)_{\mathcal{R}} &:= \mathcal{I} \setminus \{U, V\}. && \text{(open interval)} \end{aligned}$$

Obviously, for all $U, V \in \mathcal{R}$,

$$[U, V]_{\mathcal{R}} \neq \emptyset \quad \Leftrightarrow \quad U \supset V,$$

so that non-empty intervals necessarily have a causal direction. Although the previous definition covers open, half-open, and closed intervals, we will see further down that only closed intervals play an important rôle in the context of interventions.

For example, in Fig. 17 we have:

$$\begin{aligned} [S_0, S_{12}]_{\mathcal{R}} &= \{S_0, S_2, S_5, S_{12}\} \\ [S_0, S_{12})_{\mathcal{R}} &= \{S_0, S_2, S_5\} \\ [S_{12}, S_0]_{\mathcal{R}} &= \emptyset. \end{aligned}$$

In a random experiment, two sub-processes with the same initial conditions can lead to two different outcomes. Next, I define a *bifurcation* and a *discriminant*, the former corresponding to the exact moment when these two processes separate from each other and the latter to the instant right afterwards—that is, the instant that unambiguously determines the start of

a new causal course. Notice that in what follows, I will drop the subscript \mathcal{R} when it is clear from the context.

Definition 13 (Bifurcations & Discriminants). Let \mathcal{R} be a set of realisations, and let $\mathcal{I}_1 = [U, V_1]$ and $\mathcal{I}_2 = [U, V_2]$ be two closed intervals in \mathcal{R} with same initial starting point U and non-overlapping endpoints $V_1 \cap V_2 = \emptyset$. A member $\lambda \in \mathcal{R}$ is said to be a *bifurcation* of \mathcal{I}_1 and \mathcal{I}_2 iff $[U, \lambda] = \mathcal{I}_1 \cap \mathcal{I}_2$. A member $\xi \in \mathcal{R}$ is said to be a *discriminant* of \mathcal{I}_1 from \mathcal{I}_2 iff $\mathcal{I}_1 \setminus \mathcal{I}_2 = [\xi, V_1]$.

For instance, relative to the causal space in Fig. 17, consider the intervals

$$[S_0, S_7]_{\mathcal{R}} \quad \text{and} \quad [S_0, S_9]_{\mathcal{R}}.$$

Then, the bifurcation is S_1 , because

$$[S_0, S_7]_{\mathcal{R}} \cap [S_0, S_9]_{\mathcal{R}} = [S_0, S_1]_{\mathcal{R}};$$

and their discriminants are S_3 and S_4 respectively, because

$$\begin{aligned} [S_0, S_7]_{\mathcal{R}} \setminus [S_0, S_9]_{\mathcal{R}} &= [S_3, S_7]_{\mathcal{R}} \quad \text{and} \\ [S_0, S_9]_{\mathcal{R}} \setminus [S_0, S_7]_{\mathcal{R}} &= [S_4, S_9]_{\mathcal{R}}. \end{aligned}$$

In principle, bifurcations and discriminants might not exist; or if they exist, they might not be unique. The following lemma disproves this possibility by showing that bifurcations and discriminants always exist and are unique.

Lemma 14. *Let \mathcal{R} be a set of realisations, and let $\mathcal{I}_1 = [U, V_1]$ and $\mathcal{I}_2 = [U, V_2]$ be two closed intervals in \mathcal{R} with same initial starting point U and non-overlapping endpoints $V_1 \cap V_2 = \emptyset$. Then, there exists*

- a) *a unique bifurcation of \mathcal{I}_1 and \mathcal{I}_2 ;*
- b) *a unique discriminant of \mathcal{I}_1 from \mathcal{I}_2 ;*
- c) *and a unique discriminant of \mathcal{I}_2 from \mathcal{I}_1 .*

Proof: First, we observe that there cannot be any $V \in \mathcal{I}_1$ such that $V \cap V_1 = \emptyset$. For if this was true, then we would have that for all $W \in [V, V_1]$, $W \cap V_1 = \emptyset$, which would lead to a contradiction since we know that for $W = V_1$, $W \cap V_1 \neq \emptyset$. Repeating the same argument for \mathcal{I}_2 , we also conclude that there cannot be any $V \in \mathcal{I}_2$ such that $V \cap V_2 = \emptyset$.

Second, using a similar argument as above, if $V \in \mathcal{I}_1$ is such that $V \cap V_2 = \emptyset$, then for all $W \in [V, V_1]$, $W \cap V_2 = \emptyset$; and if $V \in \mathcal{I}_1$ is such that $V \cap V_2 \neq \emptyset$, then for all $W \in [\Omega, V]$, $W \cap V \neq \emptyset$. This leads us to conclude that \mathcal{I}_1 can be partitioned into

$$\begin{aligned} [U, R_1] &:= \{W \in \mathcal{I}_1 : W \cap V_2 \neq \emptyset\} \\ \text{and } (S_1, V_1] &:= \{W \in \mathcal{I}_1 : W \cap V_2 = \emptyset\}, \end{aligned}$$

for some $R_1, S_1 \subset \Omega$, that is to say, where $\mathcal{I}_1 = [U, R_1] \cup (S_1, V_1]$ and $[U, R_1] \cap (S_1, V_1] = \emptyset$. But, due to axiom R4, both intervals must be closed. Hence, in particular, it is true that $[\Omega, R_1] = [\Omega, \lambda_1]$ for some $\lambda_1 \in \mathcal{I}_1$. Similarly, \mathcal{I}_2 can be partitioned into

$$\begin{aligned} [U, R_2] &:= \{W \in \mathcal{I}_2 : W \cap V_1 \neq \emptyset\} \\ \text{and } (S_2, V_2] &:= \{W \in \mathcal{I}_2 : W \cap V_1 = \emptyset\}, \end{aligned}$$

and again, $[U, R_2] = [U, \lambda_2]$ for some $\lambda_2 \in \mathcal{I}_2$. Now, if $W \in \mathcal{I}_1 \cup \mathcal{I}_2$, then $W \in [U, \lambda_1] \Leftrightarrow W \in [U, \lambda_2]$. Hence, $\lambda_1 = \lambda_2$ is

unique and is a bifurcation, proving part (a). For parts (b) and (c), we note that $(R_1, V_1) = [\xi_1, V_1]$ and $(R_2, V_2) = [\xi_2, V_2]$ for some $\xi_1 \in \mathcal{I}_1 \setminus \mathcal{I}_2$ and $\xi_2 \in \mathcal{I}_2 \setminus \mathcal{I}_1$ respectively due to axiom R4. But since $\mathcal{I}_1 \setminus \mathcal{I}_2 = \mathcal{I}_1 \setminus [U, \lambda_1] = [\xi_1, V_1]$, and similarly $\mathcal{I}_2 \setminus \mathcal{I}_1 = [\xi_2, V_2]$, the members ξ_1 and ξ_2 are the desired discriminants, and they are unique. ■

The important consequence of this lemma is that there is always a pair of closed intervals $[\lambda, \xi_1]$ and $[\lambda, \xi_2]$ that precisely capture the sub-process, or *mechanism*, during which a realisation can split into two mutually exclusive causal branches.

To intervene a random experiment in order to give rise to a particular event A , we first need to identify all the sub-processes that can split the course of the realisation into intervals leading to A or its negation A^c . These sub-processes will start and end at instants that will be called A -bifurcations and A -discriminants respectively. Again, a lemma guarantees that these sub-processes exist and are unique.

Definition 15 (A -Bifurcations, A -Discriminants). Let \mathcal{R} be a set of realisations, and let $A \in \sigma(\mathcal{R})$ be a member of the generated σ -algebra of \mathcal{R} .

- 1) A member $\lambda \in \mathcal{R}$ is said to be an A -bifurcation iff it is a bifurcation of two intervals $[\Omega, V_A]$ and $[\Omega, V_{A^c}]$ with endpoints V_A and V_{A^c} in some representations of A and A^c respectively. The set of A -bifurcations is the subset $\lambda(A) \subset \mathcal{R}$ of all A -bifurcations.
- 2) Let $\lambda \in \lambda(A)$ be an A -bifurcation. A member $\xi \in \mathcal{R}$ is said to be an A -discriminant for λ iff there exists V_A in a representation of A such that $[\xi, V_A] = [\Omega, V_A] \setminus [\Omega, \lambda]$. The set of A -discriminants for λ is denoted as $\xi(\lambda)$.

Figure 18 illustrates the set of A -bifurcations for A defined as

$$A = S_7 \cup S_9 \cup S_{12} \cup S_{13} = \{1, 3, 4, 5, 6, 7\}.$$

The set of A -bifurcations is

$$\lambda(A) = \{S_0, S_1, S_2, S_3, S_4\}.$$

Each member has an associated set of A -discriminants. For instance,

$$\xi(S_0) = \{S_1, S_2\} \quad \text{and} \quad \xi(S_2) = \{S_5\}.$$

The critical bifurcations that appear in the figure are a subset of the bifurcations, and they will be defined later in the text.

Lemma 16. Let \mathcal{R} be a set of realisations, and let $A \in \sigma(\mathcal{R})$ be a member of the generated σ -algebra of \mathcal{R} . Then, the set of A -bifurcations $\lambda(A)$ and the sets of A -discriminants $\xi(\lambda)$, $\lambda \in \lambda(A)$, exist, are countable, and unique.

Proof: Let \mathcal{A}_1 and \mathcal{A}_1^c be representations of A and A^c respectively. Consider the set $\lambda_1(A) \subset \mathcal{R}$ of bifurcations of $[\Omega, V_A]$ and $[\Omega, V_{A^c}]$ generated by all pairs of endpoints $(V_A, V_{A^c}) \in \mathcal{A} \times \mathcal{A}^c$. Due to the representation theorem, we know that both \mathcal{A} and \mathcal{A}^c are countable. Therefore, $\mathcal{A} \times \mathcal{A}^c$ and $\lambda_1(A)$ are countable too. Now, repeat the same procedure to construct a set $\lambda_2(A)$ of bifurcations from two representations \mathcal{A}_2 and \mathcal{A}_2^c of A and A^c respectively.

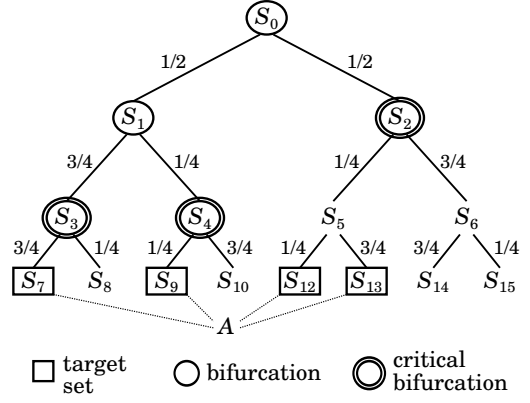

Fig. 18. A -bifurcations.

Let $R \in \lambda_1(A)$. Then, there exists $R_A \in \mathcal{A}_1$ and $R_{A^c} \in \mathcal{A}_1^c$ such that $[\Omega, R] = [\Omega, R_A] \cap [\Omega, R_{A^c}]$. Since \mathcal{A}_2 and \mathcal{A}_2^c are representations of A and A^c respectively, there must be members $S_A \in \mathcal{A}_2$ and $S_{A^c} \in \mathcal{A}_2^c$ such that $R_A \cap S_A \neq \emptyset$ and $R_{A^c} \cap S_{A^c} \neq \emptyset$. Due to axiom R2, it must be that either $R_A \subset S_A$ or $S_A \subset R_A$; similarly, either $R_{A^c} \subset S_{A^c}$ or $S_{A^c} \subset R_{A^c}$. But then, $[\Omega, S_A] \cap [\Omega, S_{A^c}] = [\Omega, R]$, implying that $R \in \lambda_2(A)$. Since R is arbitrary, $\lambda_1(A) = \lambda_2(A)$. Hence, we have proven that $\lambda(A)$ exists, is countable, and unique.

Let $\lambda \in \lambda(A)$ be an arbitrary A -bifurcation. Let \mathcal{A}_1 and \mathcal{A}_2 be two representations of A . Because A -representations are countable, there exists a countable number of intervals $[\Omega, V_A]$, $V_A \in \mathcal{A}_1$, containing λ and an associated discriminant. Let $\xi_1(\lambda)$ be the collection of those discriminants. Following an argument analogous as above, it is easy to see that $\xi_2(\lambda)$, the set of discriminants constructed from the intervals associated to the representation \mathcal{A} , must be equal to $\xi_1(\lambda)$. Hence, for each $\lambda \in \lambda(A)$, $\xi(\lambda)$ exists, is countable and unique. ■

We are now ready to define interventions on a causal space. In the next definition, an A -intervention is defined as the change of the causal measure at the bifurcations such that the desired event A will inevitably take place. This is done by removing all the probability mass leading to the undesired event A^c and renormalising thereafter.

Definition 17 (Intervention). Let \mathcal{R} be a set of realisations, P be a causal measure, and A be a member of the generated σ -algebra of \mathcal{R} . A causal measure P' is said to be an A -intervention of P iff for all $U, V \in \mathcal{R}$ such that $V \cap A \neq \emptyset$,

$$P'(V|U) \cdot G(U, V) = P(V|U), \quad (1)$$

where $G(U, V)$ is the gain of the interval $[U, V]$ defined by

$$G(U, V) := \prod_{\lambda \in \Lambda} \sum_{\xi \in \xi(\lambda)} P(\xi|\lambda). \quad (2)$$

Here, $\Lambda := [U, V] \cap \lambda(A)$ is the set of bifurcations in $[U, V]$, and each $\xi(\lambda)$ is the set of A -discriminants of $\lambda \in \Lambda$.

In the tree visualisation, an A -intervention can be thought of as a reallocation of the probability mass at the A -bifurcations (see Fig. 19). Essentially, this is done by first removing the probability mass from the transitions that do not have any

successor realisation in A and then by renormalising the remaining transitions, *i.e.* the ones rooted at A -discriminants.

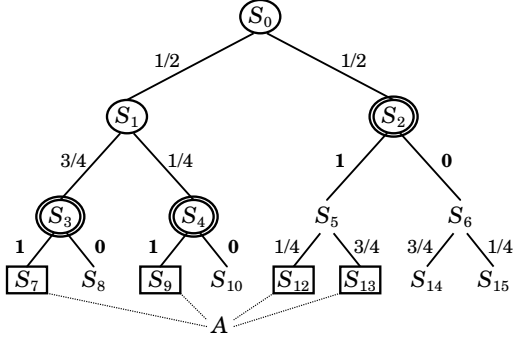

Fig. 19. A -intervention.

Theorem 18 (Uniqueness of A -Interventions). *Let \mathcal{R} be a set of realisations, P be a causal measure, and A be a member of the generated σ -algebra of \mathcal{R} . The A -intervention is unique if for each bifurcation $\lambda \in \lambda(A)$, the corresponding A -discriminants are not null, *i.e.* they are such that*

$$\sum_{\xi \in \xi(\lambda)} P(\xi|\lambda) > 0. \quad (3)$$

Proof: Let P' be an A -intervention. Because it is a causal measure, $P'(V|U) = 1$ when $V \supset U$ and $P'(V|U) = 0$ when $V \cap U = \emptyset$. It remains to check that $P'(V|U)$ is unique when $V \subset U$. If $V \cap A \neq \emptyset$, then the definition applies. Here, $\lambda(A)$ and the $\{\xi(\lambda)\}_{\lambda \in \lambda(A)}$ are unique due to Lemma 14, thus so are the $\Lambda := [U, V] \cap \lambda(A)$ for each $U, V \in \mathcal{R}$. Hence, we see that if condition (3) holds for all $\lambda \in \lambda(A)$, then (1) has a unique solution for $P'(V|U)$. Finally, if $V \cap A = \emptyset$ then $P'(V|U)$ depends on where $[U, V]$ contains an A -bifurcation. If it does not, then $P'(V|U) = P(V|U)$. If it does, then Axiom C3 implies $P'(V|U) = 0$. ■

Corollary 19. *A -interventions are unique up to intervals containing only null discriminants. In other words, given two A -interventions P'_1 and P'_2 let $U, V \in \mathcal{R}$. Then, $P'_1(V|U) = P'_2(V|U)$ if for all $\lambda \in [U, V] \cap \lambda(A)$, there exists $\xi \in \xi(\lambda)$ such that $P(\xi|\lambda) > 0$.*

Finally, the next proposition shows that the intervention is indeed correct in the sense that the desired event occurs with certainty after the intervention.

Proposition 20. *Let \mathcal{R} be a set of realisations and let A be a member of the generated σ -algebra Σ of \mathcal{R} . Furthermore, let P' be probability measure compatible with an A -intervention of a causal measure P . Then, $P'(A|\Omega) = 1$.*

Proof: Let A and A^c be representations of A and A^c in \mathcal{R} respectively. Then, each $V \in \mathcal{A}^c$ is such that $V \cap A = \emptyset$. Hence, due to (I1),

$$P'(A^c|\Omega) = \sum_{V \in \mathcal{A}^c} P'(V|\Omega) = 0.$$

But then, since P' is a probability measure,

$$P'(A|\Omega) = 1 - P'(A^c|\Omega) = 1.$$

A closer look at the definition of an A -intervention reveals that, while the set of bifurcations $\lambda(A)$ contains all the logically required bifurcations (*i.e.* all moments having a branch leading to the undesired event A^c), some of them remain unaltered after the intervention. In particular, this is always the case when the mechanisms assign zero probability to the branches leading to A^c . ■

Definition 21 (Critical Bifurcations). *Let \mathcal{R} be a set of realisations, P be a causal measure, and A be a member of the generated σ -algebra of \mathcal{R} . A bifurcation $\lambda \in \lambda(A)$ is said to be *critical* iff the corresponding A -discriminants are not complete, *i.e.* they are such that*

$$\sum_{\xi \in \xi(\lambda)} P(\xi|\lambda) < 1. \quad (4)$$

Proposition 22. *The gain (2) is equal to*

$$G(U, V) = \prod_{\lambda \in \Gamma} \sum_{\xi \in \xi(\lambda)} P(\xi|\lambda) \quad (5)$$

where Γ is the set of critical bifurcations in the interval from U to V , and each $\xi(\lambda)$ is the set of A -discriminants of $\lambda \in \Lambda$.

Proof: Partition Λ into Γ and $\bar{\Gamma} = \Lambda \setminus \Gamma$, where Γ contains only the critical A -bifurcations. Then,

$$\begin{aligned} \prod_{\lambda \in \Lambda} \sum_{\xi \in \xi(\lambda)} P(\xi|\lambda) &= \left\{ \prod_{\lambda \in \bar{\Gamma}} \sum_{\xi \in \xi(\lambda)} P(\xi|\lambda) \right\} \cdot \left\{ \prod_{\lambda \in \Gamma} \sum_{\xi \in \xi(\lambda)} P(\xi|\lambda) \right\} \\ &= 1 \cdot \left\{ \prod_{\lambda \in \Gamma} \sum_{\xi \in \xi(\lambda)} P(\xi|\lambda) \right\} = \prod_{\lambda \in \Gamma} \sum_{\xi \in \xi(\lambda)} P(\xi|\lambda). \end{aligned}$$

C. Random Variables

We recall the formal definition of a random variable. Let (Ω, Σ, P) be a probability space and (S, Ξ) be a measurable space. Then an (S, Ξ) -valued random variable is a function $X : \Omega \rightarrow S$ which is (Σ, Ξ) -measurable, *i.e.* for every member $B \in \Xi$, its preimage $X^{-1}(B) \in \Sigma$ where $X^{-1}(B) = \{\omega : X(\omega) \in B\}$. If we have a collection $(X_\gamma : \gamma \in \Gamma)$ of mappings $X_\gamma : \Omega \rightarrow S_\gamma$, then

$$\Sigma := \sigma(X_\gamma : \gamma \in \Gamma)$$

is the smallest σ -algebra Σ such that each X_γ is Σ -measurable.

The lesson we have learnt so far is that it is not enough to just specify the σ -algebra of a random experiment in order to understand the effect of interventions; rather, we need to endow the σ -algebra with a causal structure. While one would expect the same to hold for random variables one wishes to intervene, we will see that it is not necessary to explicitly model causal dependencies among them. Instead, it is sufficient to establish a link to some abstract causal space that is shared by all the random variables. We begin this investigation thus with a definition of a function having causal structure.

Definition 23 (Realisable Function). *Let Ω, S be sets and \mathcal{R} and \mathcal{S} be sets of realisations over Ω and S respectively. A*

function $X : \Omega \rightarrow S$ is said to be (\mathcal{R}, S) -realisable iff for every $B \in S$, the preimage $X^{-1}(B)$ is a member of \mathcal{R} . The following picture illustrates this:

$$\begin{array}{c} \Omega \xrightarrow{X} S \\ \\ \mathcal{R} \xleftarrow{X^{-1}} S \end{array}$$

The next proposition shows that realisable functions are measurable functions, but not vice versa—as intuition immediately predicts.

Proposition 24. *Let \mathcal{R} and S be two sets of realisations over sets Ω and S respectively. Let $\Sigma = \sigma(\mathcal{R})$ and $\Xi = \sigma(S)$. If a mapping $X : \Omega \rightarrow S$ is (\mathcal{R}, S) -realisable then it is also (Σ, Ξ) -measurable. However, the converse is not necessarily true. In a diagram:*

$$\begin{array}{ccc} \Omega \xrightarrow{X} S & & \Omega \xrightarrow{X} S \\ & \Rightarrow & \\ \mathcal{R} \xleftarrow{X^{-1}} S & & \Sigma \xleftarrow{X^{-1}} \Xi \end{array}$$

Proof: Let $B \in \Xi$. Then, Theorem 4 tells us that there exists a representation \mathcal{B} of B in S . Since X is (\mathcal{R}, S) -realisable, every member $V \in \mathcal{B}$ has a preimage that is in \mathcal{R} , i.e. $X^{-1}(V) \in \mathcal{R}$. But $\bigcup_{V \in \mathcal{B}} X^{-1}(V) = X^{-1}(B)$ and $\bigcup_{V \in \mathcal{B}} X^{-1}(V) \in \Sigma$, hence X is (Σ, Ξ) -measurable.

To disprove the converse, consider the following counterexample. Take $\Omega = \{\omega_1, \omega_2, \omega_3, \omega_4\}$ and $S = \{s_1, s_2\}$. Let $\mathcal{R} = \{R_1, \dots, R_8\}$, where: $R_1 = \Omega$; $R_2 = \{\omega_1, \omega_2\}$; $R_3 = \{\omega_3, \omega_4\}$; $R_4 = \{\omega_1\}$; $R_5 = \{\omega_2\}$; $R_6 = \{\omega_3\}$; $R_7 = \{\omega_4\}$; and $R_8 = \emptyset$. Furthermore, let $S = \{S_1, S_2, S_3, S_4\}$, where: $S_1 = S$; $S_2 = \{s_1\}$; $S_3 = \{s_2\}$; and $S_4 = \emptyset$. Let X be such that $X(R_2) = S_2$ and $X(R_6) = S_3$. Observe that $S_1 = S_2 \cup S_3 \in \Xi$ and $S_4 = S_1^c \in \Xi$, and in particular $S_1, S_4 \in S$. However, $X^{-1}(S_1) = R_2 \cup R_6$, which is obviously in Σ but not in \mathcal{R} . ■

Next, realisable random variables are simply defined as realisable functions endowed with a causal measure.

Definition 25 (Realisable Random Variable). Let (Ω, \mathcal{R}, P) be a causal space. A *realisable random variable* X is an (S, Ξ) -valued function that is (\mathcal{R}, S) -realisable, where $\Xi = \sigma(S)$.

Finally, we define the intervention of a random variable. Let B be a measurable event in Ξ , the σ -algebra in the range of X . Then, a B -intervention of X is done in two steps: first, B is translated into its corresponding event A living in the abstract σ -algebra Σ ; second, the resulting event A is intervened.

Definition 26 (Intervention of a Random Variable). Let (Ω, \mathcal{R}, P) be a causal space and let X be a (\mathcal{R}, S) -realisable random variable. Given a set $B \in \Xi = \sigma(S)$ of the generated σ -algebra, a B -intervention of the realisable random variable X is a $X^{-1}(B)$ -intervention of the causal measure P .

Corollary 27. *B -interventions of a realisable random variable are unique up to intervals containing only null discriminants.*

This concludes our abstract model of causality. It is immediately seen that a causal stochastic process can be characterised as a collection $(X_\gamma : \gamma \in \Gamma)$ of (\mathcal{R}, S_γ) -realisable random variables $X : \Omega \rightarrow S_\gamma$ respectively defined over a shared causal space (Ω, \mathcal{R}, P) . This is in perfect accordance with the theory so far developed.

For instance, consider a collection of four binary random variables X, Y, Z , and U accommodated within the causal space $C = (\Omega, \mathcal{R}, P)$ from the example shown in Fig. 17. For these random variables to be realisable, they must map elements from the sample space Ω into $S = \{0, 1\}$ such that the partition induced contains only members in the set of realisations \mathcal{R} . This is achieved by ensuring that each path from the root to a leaf contains *exactly one* value assignment for each random variable (technically, a *cut* through the tree) as exemplified in Fig. 20. For instance, all the realisation paths must necessarily pass either through S_1 or S_2 where X assumes the value $X = 0$ or $X = 1$ respectively.

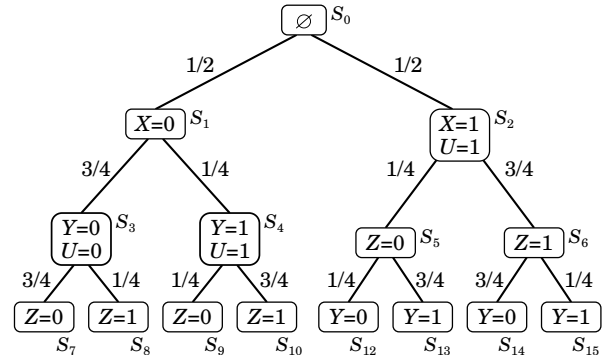

Fig. 20. A causal stochastic process.

The causal measure over \mathcal{R} extends to the random variables in the obvious way; thus here, we have

$$\begin{aligned} P(X = 0) &= \frac{1}{2}, & P(X = 1) &= \frac{1}{2}, \\ P(Y = 0|X = 0) &= \frac{3}{4}, & P(Y = 1|X = 0) &= \frac{1}{4}, \\ P(Z = 0|X = 1) &= \frac{1}{4}, & P(Z = 1|X = 1) &= \frac{3}{4}, \\ & & & \vdots \end{aligned}$$

and so on.

The example also illustrates the possibility of modelling dynamically instantiated causal dependencies. This is seen by noting that Y precedes Z if $X = 0$ but Y succeeds Z if $X = 1$, i.e. X is a second-order causal dependency that controls whether Y causes Z or *vice versa*. Obviously, the same idea can be applied to model higher-order causal dependencies.

Fig. 21 shows three interventions, namely $X \leftarrow 1$, $Z \leftarrow 1$, and $U \leftarrow 0$, where the critical bifurcations are highlighted with thicker outlines. As mentioned before, the intervention $X \leftarrow 1$ picks the direction of the causal dependency of the pair (Y, Z) by setting Z to be the cause and Y its effect. If instead the subject is interested in finding out how to bring about $Z = 1$ herself, then she can do so by inspecting the intervention $Z \leftarrow$

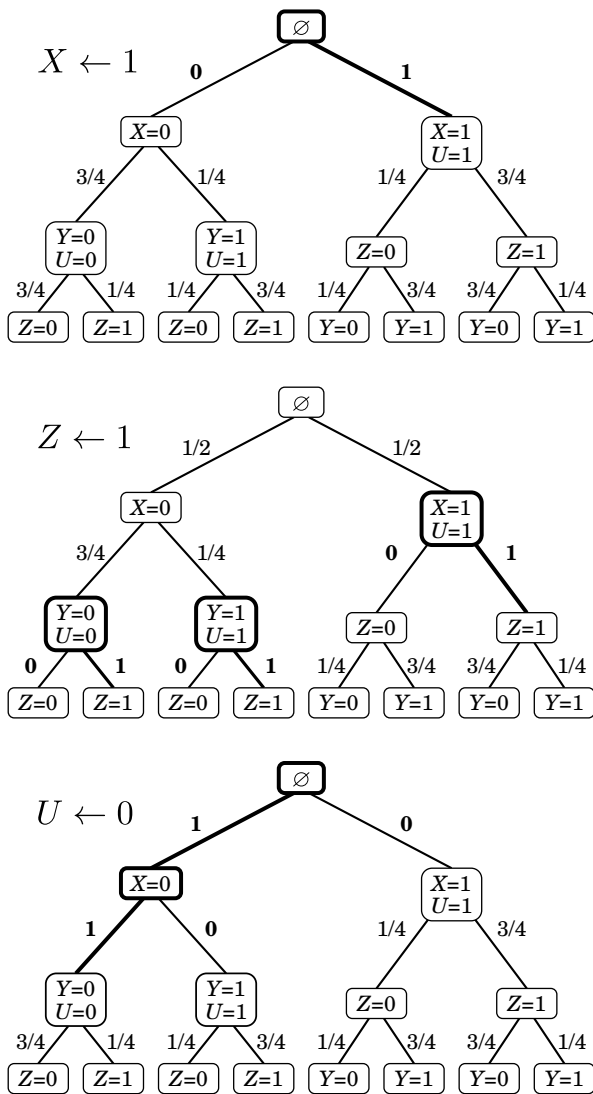

Fig. 21. Three example interventions.

1. Enumerating the critical bifurcations, she can conclude that there are three mutually exclusive circumstances where this can occur, following two different causal narratives. Finally, she decides to pick the leftmost one through the intervention $U \leftarrow 1$ which combines changes at two critical bifurcations.

REFERENCES

- Ash, R., Doléans-Dade, C., 1999. *Probability & Measure Theory*. 2nd ed., Academic Press.
- Bayes, T., 1763. An Essay towards Solving a Problem in the Doctrine of Chances. By the Late Rev. Mr. Bayes, F. R. S. Communicated by Mr. Price, in a Letter to John Canton, A. M. F. R. S. *Philosophical Transactions* 53, 370–418.
- Billingsley, P., 1978. *Ergodic theory and information*. R. E. Krieger Pub. Co.
- Burkitt, I., 2008. Subjectivity, Self and Everyday Life in Contemporary Capitalism. *Subjectivity* 23, 236–245.
- Cantor, G., 1874. Ueber eine Eigenschaft des Inbegriffes aller

- reellen algebraischen Zahlen. *Journal für die reine und angewandte Mathematik* 77, 258–262.
- Cartwright, N., 1983. *How the Laws of Physics Lie*. Oxford University Press.
- Chomsky, N., 1957. *Syntactic Structures*. Mouton & Co.
- Cox, R., 1961. *The Algebra of Probable Inference*. Johns Hopkins.
- Dawid, A.P., 2007. *Fundamentals of Statistical Causality*. Research Report 279. Department of Statistical Science, University College London.
- Dawid, A.P., 2010. Seeing and Doing: The Pearlian Synthesis, in: Dechter, R., Geffner, H., Halpern, J. (Eds.), *Heuristics, Probability and Causality*. Cambridge University Press.
- Dawid, A.P., 2015. *Statistical Causality from a Decision-Theoretic Perspective*. *Annual Review of Statistics and its Application* 2, 273–303.
- De Finetti, B., 1937. La Prévision: Ses Lois Logiques, Ses Sources Subjectives, in: *Annales de l'Institut Henri Poincaré*, pp. 1–68.
- Descartes, R., 1637. *Discours de la méthode: pour bien conduire sa raison, et chercher la vérité dans les sciences (Discourse on the Method)*.
- Feynman, R., Leighton, R., Sands, M., 1964. *The Feynman Lectures on Physics (Vol. I)*. Addison-Wesley.
- Fink, B., 1996. *The Lacanian Subject*. Princeton University Press.
- Foucault, M., 1964. *Histoire de la folie à l'âge classique (Madness and civilization: A history of insanity in the age of reason)*. Pantheon Books.
- Frege, G., 1892. Über Sinn und Bedeutung (On Sense and Reference). *Zeitschrift für Philosophie und Philosophische Kritik* 100, 25–50.
- Freud, S., 1899. *Die Traumdeutung (The Interpretation of Dreams)*. Franz Deuticke, Leipzig & Vienna.
- Heidegger, M., 1927. *Sein und Zeit*. Max Niemeyer, Tübingen.
- Hume, D., 1748. *An Enquiry Concerning Human Understanding*.
- Illari, P., Russo, F., 2014. *Causality: Philosophical Theory Meets Scientific Practice*. Oxford University Press.
- Jaynes, E., Bretthorst, L., 2003. *Probability Theory: The Logic of Science*. Cambridge University Press.
- Kim, J., 2005. *Philosophy of Mind. Dimensions of Philosophy*. 2nd edition ed., Westview Press.
- Knape, J., 2000. *Was ist Rhetorik? (What is Rhetoric)*. Reclam, Philipp, jun. GmbH.
- Kolmogorov, A., 1933. *Grundbegriffe der Wahrscheinlichkeitsrechnung*. Springer, Berlin.
- Lacan, J., 1973. *Les quatre concepts fondamentaux de la psychanalyse (The Four Fundamental Concepts of Psychoanalysis)*. Le Seuil.
- Lacan, J., 1977. *Fonction et champ de la parole et du langage en psychanalyse (The function and field of speech and language in psychoanalysis)*. Tavistock Publications. pp. 30–113. Translated by Alan Sheridan.
- Laplace, P.S., 1774. *Mémoires sur la probabilité des causes par les évènements. Mémoires de mathématique et des physiques présentés à l'Académie royale des sciences, par divers savans, & lus dans ses assemblées* 6, 621–656.

- Lauritzen, S.L., Richardson, T.S., 2002. Chain graph models and their causal interpretations. *Journal of the Royal Statistical Society: Series B (Statistical Methodology)* 64, 321–348.
- Lebesgue, H., 1902. *Integrale, longueur, aire*. Ph.D. thesis. Université de Paris.
- Mansfield, N., 2000. *Subjectivity: Theories of the Self from Freud to Haraway*. NYU Press.
- Maturana, H., 1970. *Biology of Cognition*. Technical Report. Biological Computer Laboratory: Urbana, IL.
- Maturana, H., Varela, F., 1987. *The Tree of Knowledge: The biological roots of human understanding*. 1st ed., Shambala Publications, Inc.
- Menzies, P., Price, H., 1993. Causation as a secondary quality. *British Journal for the Philosophy of Science*, 187–203.
- Nietzsche, F., 1887. *Zur Genealogie der Moral (On the Genealogy of Morality)*.
- Ortega, P., 2011. Bayesian Causal Induction, in: 2011 NIPS Workshop in Philosophy and Machine Learning.
- Osborne, M., Rubinstein, A., 1999. *A Course in Game Theory*. MIT Press.
- Pearl, J., 1993. Graphical Models, Causality, and Intervention. *Statistical Science* 8, 266–273.
- Pearl, J., 2009. *Causality: Models, Reasoning, and Inference*. Cambridge University Press, Cambridge, UK.
- Pearson, K., Lee, A., Bramley-Moore, L., 1899. *Mathematical Contributions to the Theory of Evolution. VI. Genetic (Reproductive) Selection: Inheritance of Fertility in Man, and of Fecundity in Thoroughbred Racehorses*. *Philosophical Transactions of the Royal Society of London. Series A, Containing Papers of a Mathematical or Physical Character* 192, 257–330.
- Popper, K., 1934. *The Logic of Scientific Discovery (Routledge Classics)*. Routledge.
- Quine, W., 1951. Two Dogmas of Empiricism. *The Philosophical Review* 60, 20–43. Reprinted in W.V.O. Quine, *From a Logical Point of View (Harvard University Press, 1953; second, revised, edition 1961)*.
- Ramsey, F.P., 1931. *The Foundations of Mathematics and Other Logical Essays*. reprinted ed.. Harcourt, Brace and Co., New York. chapter ‘Truth and Probability’.
- Rubin, D., 1974. Estimating Causal Effects of Treatments in Randomized and Nonrandomized Studies. *Journal of Educational Psychology* 66, 688–701.
- Russell, B., 1905. On Denoting. *Mind* 14, 479–493.
- Russell, B., 1913. On the Notion of Cause. *Proceedings of the Aristotelian Society* 13, 1–26.
- Russell, S., Norvig, P., 2009. *Artificial Intelligence: A Modern Approach*. 3rd edition ed., Prentice-Hall, Englewood Cliffs, NJ.
- Salmon, W., 1980. Probabilistic Causality. *The Pacific Philosophical Quarterly and Personalist* 61, 50–74.
- de Saussure, F., 1916. *Cours de linguistique générale (Course in General Linguistics)*.
- Savage, L., 1954. *The Foundations of Statistics*. John Wiley and Sons, New York.
- Sejnowski, T., van Hemmen, J., 2006. *23 Problems in Systems Neuroscience*. Oxford University Press.
- Shafer, G., 1996. *The Art of Causal Conjecture*. MIT Press.
- Simon, H., 1977. *Models of Discovery: and Other Topics in the methods of Science*. Boston Studies in the Philosophy and History of Science (Book 54), Springer.
- Spirtes, P., Scheines, R., 2001. *Causation, Prediction, and Search*, Second Edition. MIT Press.
- Suppes, P., 1970. *A Probabilistic Theory of Causality*. Amsterdam: North-Holland Publishing Company.
- Tallis, R., 1996. Burying Freud. *Lancet* 347, 669–671.
- Turing, A.M., 1936–1937. On computable numbers, with an application to the *Entscheidungsproblem*. *Proceeding of the London Mathematical Society, series 2* 42, 230–265.
- Von Neumann, J., Morgenstern, O., 1944. *Theory of Games and Economic Behavior*. Princeton University Press, Princeton.
- Žižek, S., 1992. *Looking Awry: An Introduction to Jacques Lacan through Popular Culture*. The MIT Press.
- Žižek, S., 2009. *The sublime object of ideology*. The Essential Žižek. 2nd ed., Verso.
- Williams, D., 1991. *Probability with Martingales*. Cambridge mathematical textbooks, Cambridge University Press.
- Williamson, J., 2009. Probabilistic theories of causation. Oxford University Press. pp. 185–212.
- Wittgenstein, L., 1921–1933. *Logisch-Philosophische Abhandlungen (Tractatus Logico-Philosophicus)*. *Annalen der Naturphilosophie*.
- Wittgenstein, L., 1953. *Philosophische Untersuchungen (Philosophical Investigations)*. Blackwell. Translated by G.E.M. Anscombe.
- Woodward, J., 2013. Causation and Manipulability, in: Zalta, E.N. (Ed.), *The Stanford Encyclopedia of Philosophy*. winter 2013 ed.