DEEP EMOTION RECOGNITION IN TEXTUAL CONVERSATIONS: A SURVEY

A PREPRINT

• **Patrícia Pereira**

INESC-ID and Instituto Superior Técnico,
Universidade de Lisboa,
Portugal
patriciaspereira@tecnico.ulisboa.pt

• **Helena Moniz**

INESC-ID and Faculdade de Letras,
Universidade de Lisboa,
Portugal
helena.moniz@inesc-id.pt

• **Joao Paulo Carvalho**

INESC-ID and Instituto Superior Técnico,
Universidade de Lisboa,
Portugal
joao.carvalho@inesc-id.pt

May 24, 2024

ABSTRACT

While Emotion Recognition in Conversations (ERC) has seen a tremendous advancement in the last few years, new applications and implementation scenarios present novel challenges and opportunities. These range from leveraging the conversational context, speaker and emotion dynamics modelling, to interpreting common sense expressions, informal language and sarcasm, addressing challenges of real time ERC, recognizing emotion causes, different taxonomies across datasets, multilingual ERC to interpretability. This survey starts by introducing ERC, elaborating on the challenges and opportunities pertaining to this task. It proceeds with a description of the emotion taxonomies and a variety of ERC benchmark datasets employing such taxonomies. This is followed by descriptions of the most prominent works in ERC with explanations of the Deep Learning architectures employed. Then, it provides advisable ERC practices towards better frameworks, elaborating on methods to deal with subjectivity in annotations and modelling and methods to deal with the typically unbalanced ERC datasets. Finally, it presents systematic review tables comparing several works regarding the methods used and their performance. The survey highlights the advantage of leveraging techniques to address unbalanced data, the exploration of mixed emotions and the benefits of incorporating annotation subjectivity in the learning phase.

Keywords Emotion Recognition · Conversations · Deep Learning · Sentiment Analysis · Dialogue

1 Introduction

Emotion recognition capabilities are essential not only for successful interpersonal relationships, but also for human-machine interaction. Understanding and knowing how to react to emotions significantly improves the interaction and its outcome. It is therefore a crucial component in the development of empathetic machines, which substantially enriches the experiences these can provide.

Emotion Recognition in Conversation (ERC) modules are useful for a wide range of applications, from automatic opinion mining, to emotion-aware conversational agents and as assisting modules for therapeutic practices. ERC is therefore an actively growing research field, with high applicability and potential. Figure 1 depicts the evolution of the number of ERC publications across the years, using the most established benchmark datasets [8][97][139][70],

supporting the observation that the field is indeed growing. Note that it does not account for datasets that contain emotion causes, a research direction that recently gained traction, neither datasets from shared tasks.

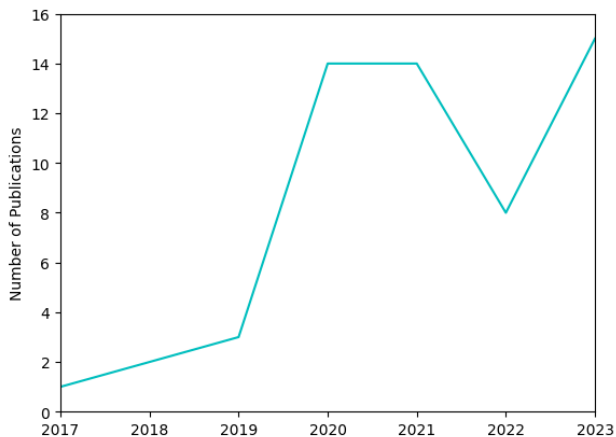

Figure 1: Evolution of the number of ERC publications across the years

It should be noted that emotions are only fully recognizable by the person having the emotion. Thus emotion recognition should be interpreted as *"inferring an emotional state from observations of emotional expressions and behavior, and through reasoning about an emotion-generating situation"* [93].

Progress in ERC benefits from the advancements in Sentiment Analysis, particularly in dialogues, whose tasks include determining the polarity and emotion of text. Research in Sentiment Analysis has come a long way and there is a perception that the field has reached its maturity, but there are still aspects and sub-tasks that need to be thoroughly addressed in order to attain true sentiment understanding [96]. Such statement applies to ERC as well. Emotion and sentiment are used interchangeably throughout this survey, but one should bear in mind they have different meanings: emotion is a psychological state while sentiment is the mental attitude created through the existence of the emotion [16].

The conversational setting presents additional challenges and opportunities, besides the ones pertaining to Emotion Recognition, such as the presence of intricate dependencies between the emotional states of the subjects who participate in the conversation, and the use of context and common sense to express emotions, amongst others described in this survey.

1.1 Survey Contributions

To the best of our knowledge, the existent surveys on Emotion Recognition in Conversations are by Poria et al [99], focusing on the challenges and advances in text ERC, pointing out conversational context modelling, speaker specific modelling, the presence of emotion shift, multiparty conversations and the presence of sarcasm, and a more recent survey by Fu et al [27], on multimodal ERC, that covers context modeling in conversations, speaker dependency, methods for fusing multimodal information and presents challenges such as real world ERC and classification on the typical ERC imbalanced datasets.

Our survey discusses additional challenges for this task, such as recognizing emotion causes, different taxonomies across datasets, multilingual ERC and interpretability. It also extensively covers solutions to dealing with the imbalanced ERC datasets and to learning with subjectivity from annotators.

This is also the first survey presenting an extensive list of Deep Learning works in ERC, stating their methods, modalities and performance across various datasets, while also describing key works on the topic.

Moreover, our survey provides comprehensive descriptions of Deep Learning methods from the Multi Layer Perceptron, Recurrent Neural Networks, Long Short-Term Memory Networks, Gated Recurrent Units, Convolutional Neural Networks, Graph Neural Networks, Attention Mechanisms to the Transformer, in the light of Emotion Recognition in Conversations. While these methods are transversal to all emotion recognition tasks, and therefore all emotion recognition surveys, some are more appropriate for ERC. Examples are Transformer-based architectures that are better at preserving long-term dependencies between sequences of utterances than recurrent neural networks.

Related relevant surveys covered sentiment analysis research challenges and directions [96] and textual emotion recognition and its challenges [19], the latter including a section on textual emotion recognition in dialogue, elaborating on utterance context modelling and dynamic emotion modelling. However, these are not specific for conversations, not specifying how the models and practices employed in general textual emotion recognition relate to conversations, neither covering the several challenges we cover since such challenges pertain to ERC.

We also set up an online repository¹ with the sources we present, organized into categories such as overviews, datasets and works on ERC.

1.2 Survey Methodology

For the review of ERC works, we have used the keyword “emotion” for most of the research references in top NLP conferences (ACL, EMNLP, NAACL, COLING, Findings) and also other conferences such as AACL, INTERSPEECH and ICASSP and journals such as IEEE Access and TAFFC. We also resorted to searching mechanisms that output similar papers when prompted with a paper such as Connected Papers. For the sections on specific topics, we searched for the respective topics’ keywords.

1.3 Outline

This survey is organised as follows: Section 1 introduces the topic of Emotion Recognition in Conversations and Section 2 presents its challenges and opportunities. Section 3 describes the emotion taxonomies and a variety of ERC benchmark datasets employing such taxonomies. Section 4 provides descriptions of the most prominent works in ERC and explains the Deep Learning architectures employed. Section 5 describes advisable ERC practices towards better frameworks, elaborating on methods to deal with subjectivity in annotations and methods to deal with the typically unbalanced ERC datasets. Section 6 consists in systematic review tables comparing several works regarding the methods used and their performance. Section 7 provides insights into how the aforementioned works attempted to solve the ERC challenges presented in section 2. Finally, Section 8 presents the conclusions and takeaways of the study.

2 ERC Challenges and Opportunities

Research in ERC has come a long way and several challenges have been addressed, as described in this section. From context, to speaker and emotion shift modelling to interpreting common sense, informal language and sarcasm, Deep Learning architectures have demonstrated its potential to address this aspects, although there is room for improvement. Application scenarios such as real time ERC pose additional challenges. In this section, we describe the challenges and point to the sections that are connected with each challenge and in Section 7 we wrap up the challenges, elaborating on how they are currently being addressed.

2.1 Context, Speaker and Emotion Dynamics Modelling

While early works [60][129] have tackled challenges from conversational context modelling, to speaker specific modelling and emotion dynamics, recent ERC approaches have leveraged the novel developments in Deep Learning to address this aspects.

Context modelling can be interpreted as leveraging information from previous or surrounding words or utterances. Speaker specific modelling leverages information about each speaker’s utterances, capitalizing on the fact that an utterance belongs to a given speaker, being extremely important in multiparty conversations. Emotion dynamics concerns the variations of the emotions of the participants in the conversation, being more informative but also harder to model than emotion shift. Emotions concern not only who expresses them but also the receiver. For example, more conscious and reflective people tend to be more sensitive regarding other’s emotions.

Concerning these challenges, gated and graph-based neural networks and transformer-based architectures are successful at modelling long range dependencies between words in utterances and relations between utterances. Key ERC works on Section 4 are described with regards to how these Deep Learning architectures were employed to address these challenges.

¹<http://github.com/patricia-pereira/deep-emotion-recognition-in-textual-conversations>

2.2 Common Sense, Informal Language and Sarcasm

Contextual embeddings from language models, such as BERT [20] and RoBERTA [73], are pre-trained with large amounts of data, which makes them suitable to deal with informal language, sarcasm and the use of common sense to express emotions, although there is room for improvement. Most of the ERC works featured in this survey make use of these contextual embeddings.

Regarding common sense, commonsense knowledge bases such as COMET [5] were developed to aid in leveraging the meaning behind phrases employing such knowledge. Three key ERC works described in Section 4 make use of knowledge bases. These knowledge bases, however, are not specific for emotions, which could be an extension to consider.

Concerning sarcasm, speaker specific modelling can aid in identifying the sarcastic participants in the conversation, to more accurately classify their utterances [99].

2.3 Real Time ERC

Systems to be deployed in a real life conversational scenarios may require real time emotion recognition [24], which is challenging not only for modelling and recognition but also in annotation because emotion expressions have to be simultaneously identified as its boundaries [93]. Datasets such as the ones described in subsection 3.2.7 feature annotations in continuous time, being more suitable for real time ERC.

2.4 Recognizing Emotion Causes

Recognizing emotion causes, or what triggered the emotions in the conversation, is also an only recently addressed challenge [98][121][50]. It involves resorting to datasets enriched with emotion causes, guiding classifiers to identify not only the emotion at stake but also what caused that emotion to arise. Addressing this challenge can greatly contribute towards more complete emotion understanding.

2.5 Different Taxonomies

With the use of different taxonomies and taxonomy types, as described in subsection 3.1 and reflected in the different emotion representations in the datasets in subsection 3.2, it is not straightforward to compare and establish connections between the different datasets, making it difficult, for example, to fine-tune the same ERC model with data from more than a few datasets in which adjustments can be made to their respective taxonomies.

2.6 Multilingual ERC

Most of the benchmark datasets used to evaluate models and develop ERC applications are in English, as it can be observed in subsection 3.2. Translating the English conversations to the target application languages is not ideal, since some emotion can be lost in translation. The collection and annotation of multilingual datasets for ERC would benefit research in this direction. There are also dialogues that involve code-switching, i.e., featuring several languages in the same dialogue or even utterance, posing an additional challenge [56].

2.7 Interpretability

A property lacking in most of the works resorting to deep learning architectures is interpretability. It is difficult to interpret the reasoning behind these models' decisions and identify what are the characteristic features of each class. Examining attention weights are a way of determining to which features the models were attending to while computing classifications which can aid interpretability although there are some issues raised in the community [49, 126].

3 ERC Taxonomies and Benchmark Datasets

In this section, a description of different taxonomies, i.e., ways of representing emotions, is provided, followed by the presentation of various datasets that resort to such taxonomies. The "dialogues in the datasets reflect our daily communication way" [70], therefore encompassing several emotions across different taxonomies.

3.1 Emotion Taxonomies

One of the most important issues in the study of emotion is whether there are basic types of affect or whether affective states should be modelled as combinations of locations on shared dimensions [138]. These two dominant views corresponded to the categorical approach, defended by Panksepp [88], and to the dimensional approach, proposed by Russell [106], respectively. This is reflected in two main taxonomy approaches, that are described and compared in this section. The Plutchik [94] wheel of emotions is also described.

3.1.1 Dimensional vs Categorical Approach

The description of emotions can follow a dimensional approach, a continuous model that allows for an unlimited states' description. Following this approach, an emotion is described by a range of values for valence, arousal and dominance, the so called VAD model [82]. Valence is a measure of pleasure or displeasure of an emotion: happiness has a positive valence, fear has a negative valence; arousal ranges from excitement to calmness: anger is high in arousal, sadness is low in arousal; dominance measures how much choice one has over an emotion: fear is low dominance, admiration is high dominance. The distribution of common emotions over the VAD 3-dimensional space can be observed in Figure 2.

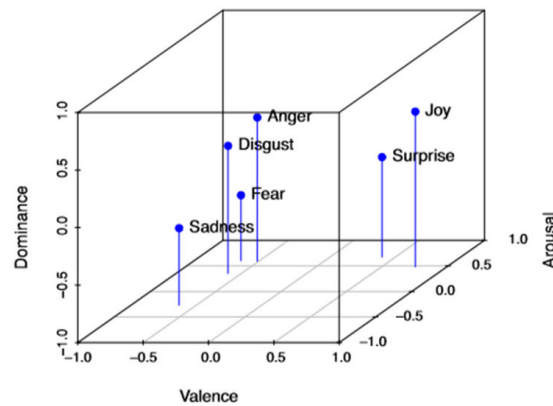

Figure 2: Distribution of common emotions over the VAD 3-dimensional space [3]

Although there are only three dimensions, the unlimited states' possibility makes annotations hard.

A motivation for the use of the dimensional description could be the existence of mixed emotions, elaborated in subsection 3.1.3.

The description can also follow a categorical approach, in which an emotion is assigned to one or more labels from a set of classes. Comparing to the dimensional approach, this categorical discrete framework makes it easier to annotate emotions but is more limited. Several scholars proposed to identify a set of primary emotions. Ekman's basic emotions constitute a standard for this emotion description, categorized into joy, anger, sadness, surprise, fear, and disgust [22].

3.1.2 Plutchik Wheel of Emotions

The Plutchik wheel of emotions, depicted in Figure 3, identifies eight core emotions, organized in opposite pairs of a wheel: sadness and joy, anger and fear, expectation and surprise, and trust and disgust. These have associated emotions according to its intensities and also combine to form new emotional states [94].

3.1.3 Mixed Emotions

A person can experience simultaneously several emotions. For example, one can experience joy and surprise at the same time and sometimes even opposite emotions simultaneously [4]. While the VAD model allows for an unlimited description of emotions so that a mixture of emotions can be expressed in a single VAD description, the single label categorical approach does not account for mixed emotions. This motivates the need to classify emotions with multiple labels when using the categorical approach. This need is very obvious when using a low number of labels, but there are also multi-label datasets with a high number of emotion labels, such as the GoEmotions dataset [18].

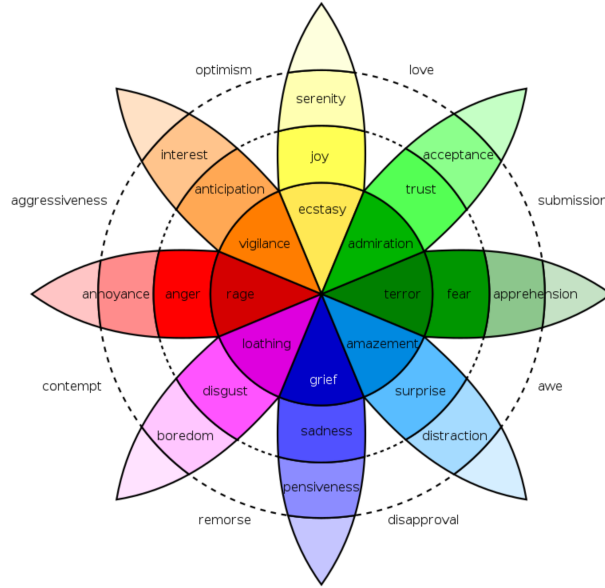

Figure 3: The Plutchik wheel of emotions. Image retrieved from Wikipedia.

3.1.4 ERC Taxonomy Considerations

The existent taxonomies are usually transversally applied along all Emotion Recognition tasks. However, for ERC, it can be observed that there are coincident predominant classes in several benchmark datasets, such as Neutral and Happiness/Joy, as it can be seen on the class distribution of the datasets on subsection 3.2. Within different ERC domains such as chit-chat vs task-oriented, such as mental health [21] and customer support [39], there are specific classes of emotions that will be more represented than others in each domain. With such a rich diversity of possible classes for this task, the dimensional approach can encompass all classes but might make it harder to distinguish between differentiated emotional displays.

3.2 ERC Benchmark Datasets

In this subsection, different categorical, single label datasets are presented, that were used by the works benchmarked in this survey. These works are organized on Tables 7 and 8. Other relevant datasets are also presented. Overall, their class imbalance is significant suggesting the use of balancing techniques that will be elaborated on in subsection 5.2. All datasets are in English, which is a limitation concerning multilingual ERC, as pointed out in section 2.

3.2.1 IEMOCAP [8]

The IEMOCAP dataset consists in 151 videos of two speakers' dialogues, comprising 7.433 utterances with an average length of 11,6 words. Each utterance is labelled with one of 8 emotions: happy, sad, neutral, angry, excited, frustrated fear and disgust. Most of the works, however, benchmark their performance on the first 6 classes, whose label distribution is displayed on Table 1. The maximum class imbalance ratio is 1:3 (happy:frustrated).

Table 1: IEMOCAP dataset label distribution.

Hap	Sad	Neutral	Ang	Exc	Frust
648	1084	1708	1103	1041	1849

Sample: "Is that, is that - is that just foam? I can't even tell. Although, if you can't tell, it's probably isn't them. It'll probably be unmistakable, don't you think?" **Label:** Excited

3.2.2 MELD [97]

The Multimodal EmotionLines Dataset (MELD) contains about 13.000 utterances from 1.433 dialogues from the TV-series Friends. Each utterance encompasses audio, visual, and textual modalities, with average length of 8,0 words.

Emotion categories are Ekman’s basic emotions and neutral. The label distribution is given in Table 2. The maximum class imbalance ratio is 1:18 (fear:neutral).

Table 2: Friends dataset label distribution.

Neutral	Ang	Dis	Fea	Joy	Sad	Sur
6436	1607	361	358	2308	1002	1636

Sample: *"Are we okay now?"* **Label:** Fear

3.2.3 EmoryNLP [139]

EmoryNLP is a text dataset extracted from transcripts of the TV show Friends. It contains 12.606 utterances, labeled with one of the six primary emotions in Willcox’s feeling wheel [127]: sad, mad, scared, powerful, peaceful, joyful, and a neutral label, whose distribution in the dataset is displayed on Table 3. The maximum class imbalance ration is 1:4 (sad:neutral).

Table 3: EmoryNLP dataset label distribution.

Neutral	Joy	Peace	Pow	Scared	Mad	Sad
3776	2755	1190	1063	1646	1332	844

Sample: *"What a coincidence, I listen in my sleep."* **Label:** Peaceful

3.2.4 DailyDialog [70]

DailyDialog is a large text dataset built from websites used to practice English dialogue in daily life, containing 12.218 multi-turn dialogues, comprising 102.879 utterances with an average length of 14,6 words. Each utterance is labelled with one of the six Ekman’s basic emotions or other. The label distribution is displayed on table 4. The maximum class imbalance ratio is 1:1156 (fear:other).

Table 4: DailyDialog dataset label distribution.

Ang	Dis	Fear	Hap	Sad	Sur	Other
1022	353	74	12885	1150	1823	85572

Sample: *"I was scared stiff of giving my first performance"* **Label:** Disgust

3.2.5 Friends [42]

Friends consists in a Friends TV Scripts corpus in which a scene is treated as a dialogue, containing 1000 text dialogues and 17.799 utterances with an average length of 10,7 words. Each utterance is labelled with one of the six Ekman’s basic emotions and neutral and non-neutral, assigned when the utterance has more than two emotions. The label distribution is given in Table 5. The maximum class imbalance ratio is 1:11 (fear:non-neutral).

Table 5: Friends dataset label distribution.

Neutral	Joy	Sad	Fea	Ang	Sur	Dis	Non-neu
7565	2215	619	283	900	2104	389	3724

Sample: *"Oh my God, oh my God! Poor Monica!"* **Label:** Surprise

3.2.6 EmoContext [10]

EmoContext consists in textual dialogues from user interaction with a conversational agent. It contains 38.424 dialogues with three turns each, with an average lenght of 7,6 words per turn, and the dialogues contain emojis. Each dialogue is labeled as angry, happy, sad or others, whose label distribution is displayed on Table 6. The maximum class imbalance ratio is 1:5 (happy:others).

Sample: *"How dare you to slap my child If you spoil my car, I will do that to you too Just try to do that once"* **Label:** Angry

Table 6: EmoContext dataset label distribution.

Happy	Sad	Angry	Others
4669	5838	5954	21963

3.2.7 Other Datasets

The SEMAINE dataset [81] consists in audiovisual recordings of interactions between a human and an operator undertaking the role of an avatar with four personalities. Its five core emotion dimensions are valence, activation, power, anticipation/expectation, and intensity.

The RECOLA dataset [103] is a multimodal corpus of spontaneous human interactions collected from a collaborative task. It includes not only audio and video, but also electrocardiogram and electrodermal activity data. Emotional behaviours are annotated in terms of arousal and valence, in continuous time, and social behaviours in terms of agreement, dominance, engagement, performance and rapport, in discrete time.

The SILICONE dataset [9] consists of preexisting datasets which have been considered challenging and interesting. It has annotations on Dialog Acts and Sentiment/Emotion. Concerning the latter, it comprises DailyDialog, MELD, IEMOCAP and SEMAINE.

4 Deep Learning for Emotion Recognition in Conversations

In this section, key ERC works are described, focusing on the challenges and opportunities of the conversational scenario, presented in Section 2 and on the diverse Deep Learning architectures that can be employed for the task. Descriptions of key Deep Learning models are provided along with descriptions of works that resorted to those models. The works on Emotion Recognition in Conversations using Deep Learning described in this survey were chosen to be representative of the different techniques that are employed, covering gated Neural Networks with and without bidirectionality, Memory Networks, Graph Neural Networks, Attention Mechanisms and Transformers. It is remarkable to observe how in four years research evolved from a simple LSTM, taking into account the context of the conversation, to complex gated and graph neural network architectures and how the invention of transformers was reflected in not only word embeddings, such as BERT, but also in new classifier architectures. Comparisons between these works are performed based on the reported weighted-F1-score without the majority class on the IEMOCAP dataset, the choice of most authors including the prominent works of [95], [37], [78], [31], [149], [107], [30], [122], [65], [108], [108] and [62], since the dataset is not too imbalanced.

4.1 Convolutional Neural Networks for Feature Extraction

Convolutional Neural Networks (CNNs) are a type of feedforward neural networks inspired by the biology of the visual cortex that mimic the local filtering over the input space performed by the receptive fields. In the case of text, a linear layer is applied to a sequence of words, each represented by its embeddings, separately and in the same way for each sequence. The convolutional layer can have many filters, each extracting a different feature, and is usually followed by a pooling operation. In the case of Emotion Recognition in Conversations, convolutional layers act as feature extractors, useful since strong predictors of the label can appear in different places in the input. With the advent of Pre-Trained Language Models for utterance representation, elaborated on subsection 4.9.4, convolutional neural networks have been less used.

4.2 The Multi Layer Perceptron

Emotion Recognition is a classification task. The most simple neural network architecture that can be employed for such task is the Multi Layer Perceptron.

The Multi Layer Perceptron (MLP) is a non-linear function approximator that can be used for classification and regression. It is a class of feed-forward artificial neural networks that is composed of at least three layers: an input layer, a hidden layer and an output layer. Its complexity and representation power increases with the number of layers. A MLP is mathematically described by the following equation:

$$\hat{y} = f_L(W_L(\dots f_2(W_2(f_1(W_1x + b_1) + b_2) \dots)) + b_L, \quad (1)$$

In which L is the number of layers, $W_l \in R^{l-1} \times R^l$ and $b \in R^l$ are the weight matrix and bias vector corresponding to layer l , and f_l is a non linear activation function corresponding to layer l . Except for the input layer, all layers' units

are followed by a non linear activation function, such as the sigmoid, the hyperbolic tangent or the rectifier linear unit. When performing classification, the last layer is followed by the sigmoid activation function for binary classification or the softmax activation function for multiclass classification. A multiclass MLP with one hidden layer can be depicted in Figure 4.

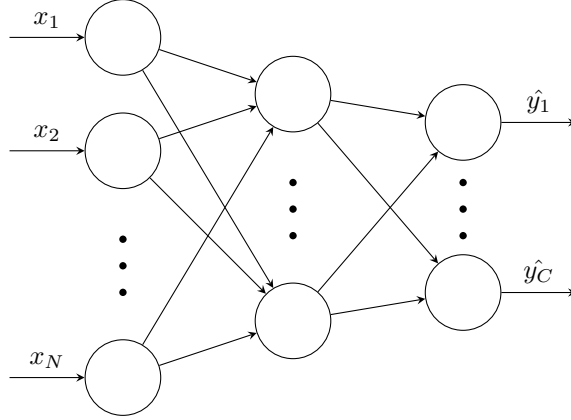

Figure 4: A Multilayer Perceptron with one hidden layer, input layer with feature dimension N and output layer with feature dimension C .

The MLP is commonly trained with the Backpropagation algorithm [105]. The idea is to update the model parameters in the opposite direction of the gradient, such that a loss computed from the prediction error is minimized. The algorithm is composed of a forward pass and a backward pass. In the forward pass, the input is passed through all the layers in the network, yielding a prediction. In the backward pass, the gradients of the model’s parameters are computed with respect to the loss function, making use of the chain rule. These are computed one layer at a time, iterating backward from the last layer. The computation of the gradients along with weight update are done following an optimization method, commonly using Stochastic Gradient Descent (SGD) algorithms.

When used for Emotion Recognition, the input to the network is a set of extracted features representing each utterance obtained for example with the Bag of Words approach for text, which does not account for the order of the words, fitting this type of network but not being the ideal method for the task. That is the main reason why state-of-the-art works do not resort to this architecture.

4.3 Elman Recurrent Neural Network

Feed-forward neural networks, such as the above, assume data has no sequential dependencies which is not the case in Emotion Recognition in which an utterance is a sequence of words that can also comprise sequential data from other modalities. Recurrent Neural Networks (RNNs) introduce memory into the network, being able to learn sequences. They process one input, such as a word, at a time, producing a hidden state which is a summary of the sequence of inputs up to the current timestep. The most simple one, the Elman RNN [23], updates the hidden state as in the following equation:

$$h_t = f(Wx_t + Uh_{t-1} + b), \quad (2)$$

where $h_t \in \mathbb{R}^h$ is the hidden state at time t , $x_t \in \mathbb{R}^N$ is the input at time t , $W \in \mathbb{R}^{h \times N}$, $U \in \mathbb{R}^{h \times h}$ and $b \in \mathbb{R}^h$ are parameters to be learned and f is a non linear activation function such as the sigmoid or the hyperbolic tangent. At each timestep the RNN can produce an output:

$$\hat{y}_t = g(Vh_t + c), \quad (3)$$

where $y_t \in \mathbb{R}^y$ is the output at time t , $V \in \mathbb{R}^{y \times h}$ and $c \in \mathbb{R}^y$ are parameters to be learned and g is a non linear activation function.

A visualization of the RNN update through time-steps is provided in Figure 5.

RNNs are trained with a modification of the Backpropagation algorithm, the Backpropagation Through Time (BPTT) algorithm [125]. All the parameters are shared between all time steps and it can be observed that an unrolled RNN is comparable to a feed-forward neural network with the same parameters shared over layers.

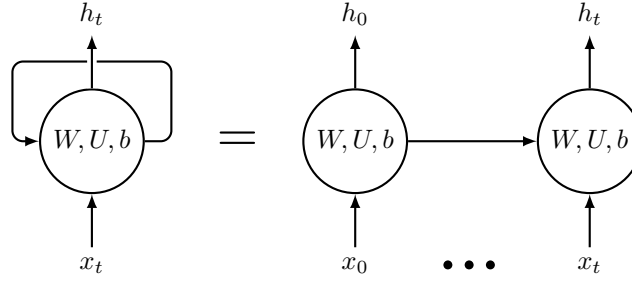

Figure 5: Two visual descriptions of the Recurrent Neural Network. The description on the left is unrolled, highlighting that parameters W , U and b are shared between timesteps.

In the case of Emotion Recognition the input to the network is a sequential utterance, for example the combination of text, audio and visuals corresponding to one word being fed per timestep, and the output is the predicted emotion.

In some cases, particularly when dealing with long sequences such as when considering several utterances to model context in Emotion Recognition in Conversations, the backpropagation algorithm yields vanishingly small gradients, preventing the parameters from changing their values and eventually stopping training.

4.4 Long Short-Term Memory Networks

To overcome this problem, Long Short-Term Memory Networks (LSTMs) [40] were proposed. LSTMs are composed of a memory cell and three gates. The memory cell stores the information about the input sequence across timesteps while the gates control the flow of information across the memory cell: the input gate controls the proportion of the current input to include in the memory cell; the forget gate the proportion of the previous memory cell to forget; the information gate the information to output from the current memory cell. This can be described by the following equations:

$$i_t = \text{sigm}(W_i x_t + U_i h_{t-1} + b_i) \quad (4)$$

$$f_t = \text{sigm}(W_f x_t + U_f h_{t-1} + b_f) \quad (5)$$

$$o_t = \text{sigm}(W_o x_t + U_o h_{t-1} + b_o) \quad (6)$$

$$c_t = f_t \odot c_{t-1} + i_t \odot \text{tanh}(W_c x_t + U_c h_{t-1} + b_c) \quad (7)$$

$$h_t = o_t \odot \text{tanh}(c_t), \quad (8)$$

where i_t is the input gate, f_t the forget gate, o_t the output gate, c_t the memory cell and sigm and tanh the element-wise sigmoid and hyperbolic tangent activation functions respectively. The several W , U and b are parameters to be learned. A visual depiction of an LSTM cell is provided in Figure 6.

The vanishing gradient problem is overcome by the gates, specially the forget gate.

As in the Elman RNN, in the case of Emotion Recognition the input to the network can be a sequential utterance and the output is the predicted emotion. LSTMs are usually leveraged to model dependencies between several sequential utterances. In this case the input to the network is a sequence of utterances.

The LSTM described in the equations above does not capture information from future time steps, which is useful for example in text applications when the context of a word is made up by both previous and subsequent words in the phrase. Therefore, Bidirectional Long Short-Term Memory networks (Bi-LSTM) [33] were proposed. Bi-LSTMs consist in two LSTMs: one executing a forward pass and the other a backward pass. A sequence of hidden states is produced for each direction that are usually joined into a unique sequence of hidden states through concatenation.

4.4.1 Context-Dependent Emotion Recognition [95]

There is a strong correlation and influence in emotion distribution between sequential utterances in a conversation. Leveraging those contextual dependencies is key to the performance of a classifier. An utterance is a unit of speech which is bound by breathes or pauses [87]. In this line, the work of [95] considers interdependences among utterances. The approach consists in an architecture made of LSTMs to extract contextual features from the utterances. The model enables consecutive utterances to share information while preserving its order. The authors propose the contextual LSTM, consisting of unidirectional LSTM cells, the hidden-LSTM, in which the dense layer after the LSTM cell is omitted and the bi-directional contextual LSTM that considers information from before and after the targeted utterance. It achieved an F1-score of 54.95% on the IEMOCAP dataset.

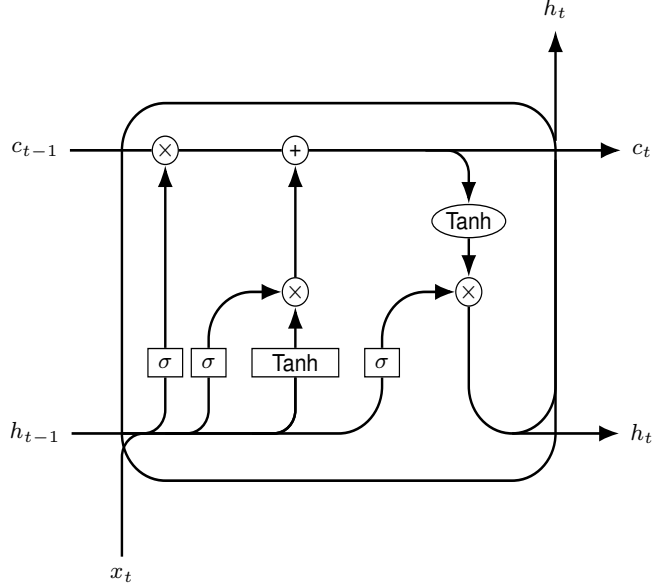

Figure 6: Long-Short Term Memory Network cell

4.5 Gated Recurrent Units

Another RNN, which structure is somehow similar but with fewer parameters than the LSTM, is the Gated Recurrent Unit (GRU) [14] that can be described by the following equations:

$$r_t = \text{sigm}(W_r x_t + U_r h_{t-1} + b_r) \quad (9)$$

$$z_t = \text{sigm}(W_z x_t + U_z h_{t-1} + b_z) \quad (10)$$

$$\hat{h}_t = \text{tanh}(W_h x_t + U_h h_{t-1} + b_h) \quad (11)$$

$$h_t = z_t \odot h_{t-1} + (1 - z_t) \odot \hat{h}_t, \quad (12)$$

in which the r_t is the reset gate that leads the candidate hidden state \hat{h}_t , to ignore or not the previous hidden state, and z_t is the update gate that controls the proportion of the information from the previous hidden state to carry over to the current hidden state.

GRUs can work better than LSTMs when there is less available data.

4.5.1 DialogueRNN [78]

DialogueRNN combines GRUs in a sophisticated way, in which each GRU plays a specific role in modelling the conversation.

DialogueRNN predicts the emotion of an utterance based on the speaker, the context of preceding utterances and the emotions from preceding utterances. The model has three components all modeled by GRUs. The party state models the parties' emotion dynamics throughout the conversation. The global state has the encoding of preceding utterances and the party state, modeling the context of the utterance. Finally, the emotion representation is based on the party state and the global state and is used to perform the final classification.

Several variants of the method are proposed. DialogueRNN_l considers an additional listener state while a speaker utters, BiDialogueRNN uses a Bi-directional RNN, DialogueRNN+Att uses attention over all surrounding emotion representations and BiDialogueRNN+Att combines the latter approaches.

It yielded an F1-score of 62.75% on the IEMOCAP dataset. The authors believe it outperforms the contextual LSTM due to better context representation.

4.6 Attention Mechanisms

The aforementioned work mentions the use of attention over surrounding emotion representations. To motivate Attention Mechanisms (AM) [2] we now introduce Sequence to Sequence (Seq2Seq) models. Seq2Seq models are composed of a RNN encoder that takes the input sequence and outputs a context vector, the last encoder hidden state, that is fed into an RNN decoder that generates an output sequence from this vector. When the input sequence is very long the context vector does not have enough capacity to represent the information from the entire sequence. This is where AM are useful. Taking inspiration from the human visual system that attends to different parts of the space, while building its representation of the scene, the AM allow the decoder to attend to the relevant encoder hidden states. At each timestep, a context vector is obtained by a weighted sum of these hidden states, where the weights of the sum are proportional to the similarity between the current decoded hidden state and the encoded hidden states, as described in the following equations:

$$a_{ti} = \frac{\exp(\text{score}(h_t^d, h_i^e))}{\sum_{j=1}^T \exp(\text{score}(h_t^d, h_j^e))} \quad (13)$$

$$c_t = \sum_{j=1}^T a_{tj} h_j^e, \quad (14)$$

where h_t^d is the decoder hidden state and h_i^e and h_j^e are the encoder hidden states. The most common similarity score function is the dot product. By introducing AM in a RNN the performance of a classifier usually increases.

4.7 Memory Networks

4.7.1 Conversational Memory Network [37]

The recurrent networks described before are limited in terms of long-range summarization. The Conversational Memory Network (CMN) accounts for this factor by the use of memory networks, which can better capture long-term dependencies and have attention models that can summarize specific details.

The work is based on the notion that emotional dynamics involves self and inter-speaker emotional influence. Separate histories for each speaker, consisting in the speaker’s previous utterances, are modeled into memory cells of the Conversational Memory Network using GRUs. Memory networks provide a memory component that can be read from and written to and also perform inference. The CMN then employs an attention mechanism over historical utterances from each speaker to filter out relevant content for the current utterance. This mechanism is repeated for multiple hops of the network to subsequently classify the utterance. CMN achieves an F1-score of 56.13% in the IEMOCAP dataset.

4.7.2 Interactive Conversational Memory Network [36]

The Interactive Conversational Memory Network (ICON) is an improvement upon CMN that has an additional dynamic global influence module to model inter-personal emotional influence, a module that maintains a global representation of the conversation, a global state that is updated using a GRU operation on the previous state and current speaker’s history. ICON yields an F1-score of 58.54% on the IEMOCAP dataset.

4.8 Graph Neural Networks

An alternative to gated neural networks that is also useful to capture long term dependencies is using graph neural networks. Graph neural networks are based on graphs. The latter model a set of objects, nodes, and their relationships, edges. While standard neural networks such as CNNs and RNNs cannot handle the graph input properly since they need a specific order for the nodes, the output of GNNs is invariant for the input order of nodes. Furthermore, while in standard neural networks, dependencies between nodes are a node feature, in GNNs there are edges to represent these dependencies. GNNs can propagate information by the graph structure instead of using it as part of features [150].

Two common types of GNNs are recurrent GNNs (RecGNNs) and convolutional GNNs (ConvGNNs). RecGNNs learn node representations with recurrent neural architectures, assuming that a node in a graph constantly exchanges information with its neighbors until a stable equilibrium is reached. ConvGNNs generalize the convolution operation from grid structure to graph structure, generating a node representation by aggregating its features with its neighbours’ features. For classification tasks, such as Emotion Recognition, an end-to-end framework can be constructed for example by stacking graph convolutional layers followed by a softmax layer [131].

4.8.1 DialogueGCN [31]

Dialogue Graph Convolutional Network (GCN) takes into account intra and inter-speaker dependency and background information, having a sequential and a speaker-level encoder. The sequential context encoder encodes the utterances using a bidirectional GRU and is speaker agnostic. The speaker-level context encoder creates a directed edge-labeled graph in which each utterance is a node in the graph. The informations from neighbor nodes are then aggregated and passed to a neural network in each node, resulting in an updated representation of each node that takes into account its neighbors. In DialogueGCN, node features are initialized with sequentially encoded feature vectors from the sequential context encoders and edge weights are set using a similarity based attention module. The utterance level emotion classification is turned into a problem of node classification in the graph. DialogueGCN achieves an F1-score of 64.18% on the IEMOCAP dataset.

4.9 Transformer

Despite the success of recurrent and graph neural networks in a wide variety of tasks including Emotion Recognition, a more powerful network model exists, constituting the current state-of-the-art: the Transformer [120]. The Transformer is also better at capturing long-term dependencies than gated RNNs, due to its shorter path of information flow, which is useful when modelling several utterances in Emotion Recognition in Conversations. It does not resort to recurrence nor convolutions. It is also more parallelizable and needs less training time. It is composed of an Encoder and Decoder, that can be visualized in Figure 7.

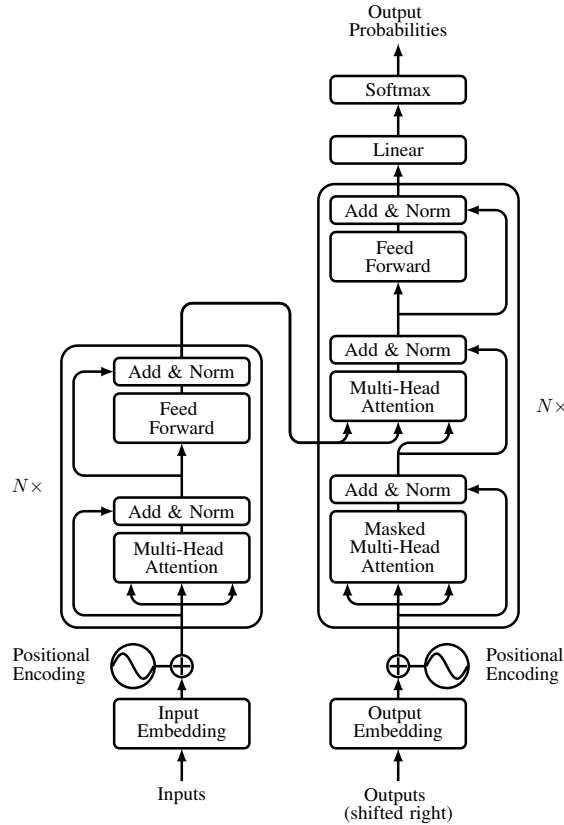

Figure 7: The Transformer. The Encoder on the left and Decoder on the right display some similar components.

Each Encoder layer is composed of two sub-layers. The first is a so called self-attention layer for building the context of the sequence that calculates the relevance of the tokens in the sequence for each given token.

The self-attention mechanism takes as input three matrices, the Query, Key and Value matrices. These are computed from the dot product between the input sequence matrix and weight matrices learned in the training phase. It then computes a vector of attention scores, as described in the following equation:

$$Attention(Q, K, V) = softmax\left(\frac{QK^T}{\sqrt{k}}\right)V, \quad (15)$$

in which $Q \in \mathbb{R}^{N \times m}$, $K \in \mathbb{R}^{N \times m}$ and $V \in \mathbb{R}^{N \times m}$ are the Query, Key and Value matrices, respectively, and m is the model output dimension. The dot product of the Query matrix with the Key matrix represents scores that are then multiplied by the Value matrix to keep intact the values of relevant words and drown-out the irrelevant ones. The $\frac{1}{\sqrt{k}}$ helps stabilizing the gradients.

The self-attention layer uses a multi-head attention mechanism so that the attention score vectors do not exclusively give a high probability score for its corresponding token, defined by the following equations:

$$MultiHead(Q, K, V) = Concat(head_1, \dots, head_h)W^O, \quad (16)$$

where

$$head_i = Attention(QW_i^Q, KW_i^K, VW_i^V), \quad (17)$$

in which $W_i^Q \in \mathbb{R}^{m \times k}$, $W_i^K \in \mathbb{R}^{m \times k}$ and $W_i^V \in \mathbb{R}^{m \times v}$ are projection matrices and $W^O \in \mathbb{R}^{hv \times m}$, being h the number of heads and $k=v=m/h$.

The output of the self-attention layer is fed to the second layer, a fully connected feed-forward network, with two linear transformations with a ReLU activation in between, applied separately and in the same way to each position, allowing for parallelization.

A residual connection is applied around each of the two sub-layers, followed by layer normalization.

Each Decoder layer is composed of three sublayers. The first is a masked self-attention layer similar to the self-attention layer described mathematically in Equations 16 and 17, but in which each position in the decoder attends to all positions in the decoder up to and including that position, which is attained by masking out values in the softmax. The second is a ‘‘encoder-decoder attention’’ layer, described mathematically in the same equations, where K and V come from the output of the encoder and Q comes from the output of the decoder’s masked self-attention layer, mimicking the typical encoder-decoder attention mechanisms in Seq2Seq models. The last layer is a feed-forward neural network, similar to the Encoder layer.

Similar to the Encoder, a residual connection is applied around each of the two sub-layers, followed by layer normalization.

Positional encodings are added to the embeddings that are fed to the Encoder and Decoder to introduce information about the position of the tokens in the sequence.

The most common use of the Transformer is as backbone for a fine-tune pre-trained transformer-based language model, such as BERT [20], described in subsection 4.9.4. These language models are trained with large amounts of data to perform many tasks and only need to be fine-tuned for the specific task at hand. In the case of a classification task such as Emotion Recognition one just needs to add a linear layer or a more complex neural network architecture on top of the language model. The training is performed with supervised learning, resorting to backpropagation algorithms.

4.9.1 Knowledge-Enriched Transformer [149]

The invention of the Transformer [120] led to new state-of-the-art results in several Natural Language Processing tasks. The Knowledge-Enriched Transformer (KET) uses self-attention to model context and response using the Transformer, that has shorter path of information flow than gated RNNs, overcoming the difficulty in capturing long-term dependencies. Conversations are modeled in the entire Transformer.

First, concepts are retrieved for each word in the conversation using an external knowledge base, a graph of concepts, then the concept representation is computed using a dynamic context-aware graph attention mechanism over the concepts, using measures of relatedness and affectiveness. Self-attention is used to learn utterance representations individually and hierarchical self attention is applied to the context to learn the context representation. After having the context passed into the encoder the response is passed into the decoder. Finally, the encoder and decoder attention mechanism is applied, followed by max pooling and a linear layer. KET achieves an F1-score of 59.56% on the IEMOCAP dataset.

4.9.2 CESTa [122]

The CESTa or Contextualized Emotion Sequence Tagging approaches ERC as a task of sequence tagging, choosing the set of tags with the highest likelihood for the whole utterance sequence at once, by using a Conditional Random Field (CRF) [57]. In order to capture long-range global context, utterance representations are generated by a multi-layer Transformer encoder. These are then fed to a bi-LSTM encoder that captures self and inter-speaker dependencies, resulting in contextualized representations of utterances that are then passed to the CRF layer. It achieves an F1-score of 67.10% in the IEMOCAP dataset.

4.9.3 DialogXL [107]

DialogXL is an adaptation of the pretrained language model XLNet [137], which is based on the Transformer-XL [15], for Emotion Recognition in Conversations. It replaces XLNet’s segment recurrence by a memory utterance recurrence to leverage historical utterances. These utterances’ hidden states are stored in a memory bank to reuse them while identifying a query utterance. The approach also replaces XLNet’s vanilla self-attention proposing a dialog-aware self-attention to grasp useful intra- and inter-speaker dependencies. This is composed of four types of self-attention: global and local self-attention for different sizes of receptive fields, and speaker and listener self-attention for intra- and inter-speaker dependencies. DialogXL achieves an F1-score of 65.94% on the IEMOCAP dataset.

4.9.4 Embeddings from Pre-Trained Transformer Language Models

Text features must represent words in a way that is useful for the models, in this case, numeric vectors referred to as word embeddings. These embeddings yield similar representations for similar words.

Static embeddings [83][90][84] are obtained based on the co-occurrence of adjacent words and have a fixed representation for the words, not taking into account its context.

Contrarily, contextual embeddings include information from the context in the word representation, a representation that differs according to the occurrence of the word. The only disadvantage of this kind of representation is that we cannot use pre-trained embeddings as in static embeddings so there is an inference time for generating the embeddings. The models are pre-trained with large amounts of data, in order to enable generating good embeddings. A first approach, Embeddings from Language Models (ELMo) [92] is based on a stack of two Bi-LSTMs, leveraging the full context of a word. It provides a context free representation of the word along with context information of the sense of the word and its syntax. The second approach, Bidirectional Encoder Representations from Transformers (BERT) [20], built from a Transformer encoder stack, leads to state-of-the-art results in multiple Natural Language Processing tasks. The input given to BERT is the sum of three embeddings, the token embedding corresponding to the sequence of words, the segment embedding containing information on which sentence each token belongs to, and the position embedding, defining the position of each token in the sequence and distance to other tokens taking into account the order of the sequence. An improvement upon BERT, RoBERTa [73] is trained with more data and for a longer period of time. Given that context is key for text Emotion Recognition in Conversations, contextual word embeddings are more adequate for the task than static embeddings, as it can be seen in the higher performance of works that resort to these embeddings, namely resultant from Pre-trained language models, such as BERT-based embeddings. The latter are also more tailored to deal with common sense, informal language and sarcasm, ERC challenges described in Section 2, since they are pre-trained on a large amounts of text.

4.9.5 COSMIC [30]

Besides choosing appropriate utterance representations and classifier architectures, there are other factors that can be leveraged for the task of ERC. One such factor is the commonsense knowledge of the interlocutors that plays a central role in inferring the latent variables of a conversation, such as speaker state and intent.

COSMIC extracts commonsense features resorting to COMET [5], a commonsense transformer encoder-decoder model trained on the task of generative commonsense knowledge construction that uses GPT [101] as its generative model. The approach uses RoBERTa for context independent feature extraction, passes each utterance concatenated with a relation phrase through COMET’s encoder and extracts the activations from the final time-step. COSMIC maintains a context state and attention vector which are always shared between the participants of the conversation. Five GRUs are used to model context state, internal state, external state, intent state, and emotion state, being the latter used for the emotion classification. This work achieves an F1-score of 65.28% in the IEMOCAP dataset.

4.9.6 Psychological [65]

Psychological also leverages COMET as commonsense knowledge base and resorts to RoBERTa as utterance-level encoder. It proposes SKAIG as a conversation-level encoder, a locally connected graph, where the targeted utterance receives information from that past and future context and is also self-connected.

Assuming that the influence of an utterance on contextual utterances is locally effective, the targeted node is connected with contextual nodes in a window of a given size of utterances in the past and future. Knowledge from COMET is introduced to enrich the edges with different relations. To propagate information through SKAIG a Graph Transformer [110] is used. Finally a linear unit predicts the emotion distributions. This work achieves an F1-score of 66.96% in the IEMOCAP dataset.

4.9.7 DAG-ERC [108]

Graph-based methods tend to neglect the distant utterances and sequential information. On the other hand, recurrence-based methods leverage those, but tend to update the query utterance's state with limited information from the nearest utterances. Combining both graph and recurrence structures explores their advantages and mitigates their drawbacks. This is the idea behind DAG-ERC, that regards each conversation as a directed acyclic graph (DAG), a combination of both structures. DAG-ERC is based on the DAGNN [113] architecture, with two improvements: a relation-aware feature transformation that gathers information based on speaker identity and a contextual information unit that enhances the information of historical context. The state-of-the-art RoBERTa-Large is used as feature extractor. It achieves an F1-score of 68.03% in the IEMOCAP dataset, outperforming the previous approaches.

4.9.8 ERC in a Generative Framework

With the advent of Generative Large Language Models (LLMs), such as the GPT series [100][101][7] and Llama [114], classification tasks started to be reformulated within generative frameworks. The idea is to prompt the LLM with the utterance to be classified and other relevant additional input, and request an emotion label for the utterance. Open source LLMs can also be fine-tuned and even pre-trained.

4.9.9 InstructERC [62]

In InstructERC the prompt consists in the utterance to be classified, the ERC instruction, the conversational context, the set of possible classification labels and similar utterances together with its emotion labels. The LLM is pre-trained with a speaker identification task and fine-tuned both with the main ERC task and an emotion influence prediction task to improve overall performance. Experiments were made with several LLMs, and best results were obtained with LLama2. InstructERC achieves 71.39% in the IEMOCAP dataset, outperforming the previous approaches.

5 Advisable ERC Practices

This section provides useful methods towards better ERC frameworks, from different ways of dealing with subjectivity in emotion annotation and modelling, to several ways of dealing with the typically unbalanced ERC datasets.

5.1 Learning Subjectivity

All human annotation tasks involve some degree of uncertainty, that can stem amongst other factors from the subjectivity inherent to the annotator, being Emotion Recognition amongst the most subjective tasks [119]. Given that subjectivity is the main source of uncertainty in Emotion Recognition annotation, we address uncertainty as subjectivity in this survey [104]. A good annotation practice is to resort to several annotators to avoid biasing the results towards a single annotator's subjectivity. This will naturally yield different labels from each annotator, the so called annotation disagreement. The more appropriately one deals with the disagreement in the annotated labels the more reliable will the data and classifiers be. Several techniques for dealing with disagreement are described in this section. They are divided into techniques that address subjectivity by adapting the labels, towards an estimate of a gold label, and techniques that embrace subjectivity by adapting the classifier architectures to deal with the subjectivity of the labels, leveraging such property.

5.1.1 Addressing Subjectivity

For categorical labels, considering that a gold or true label exists for each sample, the simple way to obtain it would be through majority voting, choosing the label with the most annotations. However, this does not account for the different annotator skill levels neither sample inherent difficulty.

Thus, a common process is to calculate an inter-annotator agreement score to find low agreement data. A very simplistic way of calculating inter-annotator agreement for categorical labels would be to use the percent agreement, dividing the number of agreement classifications by the total number of classifications. However, non-expert annotators do not always know which label to use so they sometimes just guess, resulting in a random label. Cohen pointed out that there is some level of agreement in these random labels and developed Cohen's Kappa to take that factor into account [80]. The related Fleiss' Kappa [26] is the adaptation of Cohen's Kappa for 3 or more annotators.

The low agreement data can then be discarded or trained on and evaluated separately from the high agreement data. It can be considered random noise if it does not reveal the existence of annotator bias [119].

For interval labels, weighted fusion of data can be performed with approaches such as the Evaluator Weighted Estimator (EWE) [34], that weights each rater's annotations based on its rater-specific inter-reliability scores, or the Weighted Trustability Evaluator (WTE) [35], which is instead based on each rater's performance consistency.

5.1.2 Embracing Subjectivity [104]

The annotator (dis)agreement can be used as privileged information for master-class learning, being viewed as samples' additional information [25] to facilitate learning in the training phase, that might or not be required for making predictions during testing to, for example, weigh positively the loss of the corresponding samples. In this setting it is useful to learn the meaning of high rater disagreement means for the particular dataset in use.

Instead of considering the existence of a hard label, as in subsection 5.1.1, one can calculate the distribution of label annotations to define a soft label distribution per sample, which encodes the subjectivity for each sample and allows for the classifier to learn label correlations. Another approach is to model the annotations of each particular rater, through an ensemble of models. It allows to give more importance to expert raters rather than novices or spammers. The addition of an "unsure" label would facilitate annotator's workload and also make the model learn the ambiguity ground-truth, although not having to predict "unsure" labels during testing. Furthermore, methods to understand whether a sample is mislabelled by certain raters or inherently ambiguous could inform the model and annotators during active learning processes.

In ERC, the context of the interactions is not always explicit and the dialogues contain a variety of topics that can exacerbate subjectivity even more, making it much more advisable to embrace subjectivity in this domain.

5.2 Dealing with Unbalanced Data

All the benchmark datasets used for ERC are unbalanced, some of them are severely unbalanced: the unbalance ratio varies from 1:3 up to 1:1156. In the presence of these unbalances, most classifiers tend to favor the majority classes which, in these datasets, corresponds to the neutral emotion class. Hence, unless the unbalance issue is addressed, most models will be trained and evaluated based on the neutral class results, which is far from intended. All classes should be equally relevant in ERC, and even when Accuracy values look acceptable, a more detailed analysis usually reveals a very poor performance in minority classes.

5.2.1 Metrics for Unbalanced Data

The performance metrics used for Emotion Recognition in Conversations are the Accuracy, Precision, Recall and F-score or F1, the harmonic mean of Precision and Recall. These are commonly used metrics in many classification applications. One can consider the weighted version of these metrics, that take into account the relative frequencies of each class, or micro-averaging, in which all samples equally contribute to the final averaged metric. Since both weighted versions and micro-averaging depend more on the classes with a bigger number of items, those are not good indicators of the performance on the minority classes. Therefore, those should not be used when the classes have the same importance and unequal frequencies. In unweighted macro-averaging the metric is computed for each class, and the results are averaged over all the classes. By maximizing an unweighted metric, one is maximizing the performance of the model in correctly classifying all classes regardless of the number of items they have.

ERC is clearly a task that deals with real-world unbalanced data. As such, a proper evaluation should always be performed on a test set that maintains the real-world unbalance of the data and using unweighted metrics such as macro F-score. Ideally, performance results on each of the individual classes should also be presented. Accuracy,

micro-averaging and weighted metrics are mostly irrelevant in what concerns the performance of the models since they are mostly dependent on the majority class, usually neutral. Unweighted metrics that are not affected by dataset unbalance, such as Recall, should also be avoided, unless used in conjunction with those that are, such as Precision.

5.2.2 Balancing Techniques

Besides the use of appropriate metrics, another way of dealing with dataset unbalance is to apply balancing techniques to the training set. Common such techniques are random under-sampling, removing observations from the majority class and random over-sampling, adding copies to the minority class. More elaborate techniques, such as Smote - Synthetic Minority Oversampling Technique [11], usually improve the results.

Balancing a training set has its advantages, but it is of utmost importance that the test set maintains the original set balance. Otherwise, metrics such as Precision and F-score are artificially improved and the model is unlikely to be effective in an unbalanced real-world dataset. It should be noted that Recall is not affected when training and testing on an artificially balanced dataset so ignoring Precision and looking only at Recall as an evaluation metric will not be a good indicator for real world performance of a model when there is a real-world imbalance among classes.

5.2.3 Few-Shot Learning

Few-Shot Learning [123] is also an efficient method for dealing with unbalanced data. Contrary to supervised learning, it does not require a high number of training examples. Instead of learning to generalize class identities from a training set to a test set, the Few-Shot Learning models learn to discriminate the similarities and differences between classes, by training a function that predicts similarity.

6 Systematic Review Tables of ERC Works

In Tables 7 and 8, a plethora of works on ERC, from 2017 to 2023, are displayed along with the methods they use and their reported performance. Tables are split by datasets and works are split by methods.

Table 7: Summary of publications on Emotion Recognition in Conversations, reporting the methods used along with their performance across several datasets. A * indicates that the work is multimodal.

Author, Year	Methods	IEMO w-F1(6)	MELD w-F1	ENLP w-F1	DD m-F1
GRU					
Jiao et al., 2020 [53]*	Bi-GRU, Attention	62.7	58.1		
Majumder et al., 2019 [78]*	Bi-GRU, Attention	62.75			
Nwe et al., 2020 [86]	Bi-GRU, Attention	63.90			
Lu et al., 2020 [75]	Bi-GRU, Attention	64.37	60.72		
Zhang et al., 2020 [140]*	Bi-GRU, Attention	65.3			
Zhang and Chai., 2021 [143]*	Bi-GRU, Attention	65.37			
LSTM					
Partaourides et al., 2020 [89]	Bi-LSTM, GRU, Attention	53.0			
Poria et al., 2017 [95]*	LSTM	54.95			
Xing et al., 2022 [134]*	Bi-LSTM, GRU, Attention	64.30	60.45		
Li et al., 2022a [69]	Bi-LSTM	64.59	60.9		
Hu et al., 2021 [44]	Bi-LSTM, Attention	66.20	58.39		
Memory Network					
Hazarika et al., 2018 [37]*	Memory Network, GRU, Attention	56.13			
Hazarika et al., 2018 [36]*	Memory Network, GRU, Attention	58.54			
Lai et al., 2020 [58]*	Memory Network, GRU, Attention	62.43			
Graph Neural Network (GNN)					
Ghosal et al., 2019 [31]	Graph Neural Network, GRU	64.18	58.10		
Ishiwatari et al., 2020 [48]	Graph Neural Network, Attention	65.22	60.91	34.42	54.31
Hu et al., 2021 [45]*	Graph Neural Network	66.22	58.65		
Sheng et al., 2020 [109]	Graph Neural Network, Bi-LSTM, Attention	66.61	58.45		
Hu et al., 2022 [43]*	Graph Neural Network, Bi-GRU	68.18	59.46		
Li et al., 2021 [68]*	Quantum-inspired Neural Network	59.88	58.00		

Continued on next page

Table 7: Summary of publications on Emotion Recognition in Conversations (continued)

Author, Year	Methods	IEMO	MELD	ENLP	DD
	Transformer				
Hazarika et al., 2021 [38]	Transformer, GRU	58.8			
Zhong et al., 2019 [149]	Transformer, Knowledge Base (KB)	59.56	58.18	34.39	53.37
Zhang et al., 2020 [142]	Transformer	61.43	58.97	35.59	54.71
Zhu et al., 2021 [151]	Transformer, KB	62.81	68.23	43.12	58.47
Kang and Cho., 2023 [54]	Transformer, GNN, Few-Shot Learning	63.16			52.83
Sun et al., 2021 [112]	Transformer, Bi-LSTM, GNN	64.10	64.22	36.38	
Li et al., 2020 [66]	Transformer	64.50	61.94	36.75	
Ghosal et al., 2020 [30]	Transformer, GRU, KB	65.28	65.21	38.15	58.48
Tu et al., 2023 [116]	Transformer, GRU, KB	65.69	66.12	39.47	
Shen et al., 2021 [107]	Transformer	65.94	62.41	34.73	54.93
Li et al., 2021 [?]	Transformer, Contrastive Learning [28]	66.18	64.81	39.04	56.29
Zhang et al., 2023 [144]	Transformer, Attention	66.35		38.93	61.22
Li et al., 2021 [65]	Transformer, GNN, KB	66.96	65.18	38.88	59.75
Xie et al., 2021 [133]	Transformer, KB, Attention	66.98	63.24		57.30
Wang et al., 2020 [122]	Transformer, Bi-LSTM, CRF	67.10	58.36		63.12
Tu et al., 2023 [117]	Transformer, Constrastive Learning	67.16	66.21	40.23	60.96
Zhang et al., 2023 [141]	Transformer, GNN	67.68	66.90	40.69	61.84
Shen et al., 2021 [108]	Transformer, DAGNN, GRU	68.03	63.65	39.02	59.33
Tu et al., 2023 [118]	Transformer, GNN, Contrastive Learning	68.49	65.34	39.20	
Yang et al., 2022 [136]	Transformer, GNN	68.73	66.18	46.11	59.76
Liu et al., 2022 [74]	Transformer, Attention	68.93	65.37		
Liang et al., 2022 [72]	Transformer, GNN	68.93	64.17	40.05	64.18
Wu et al., 2023 [130]*	Transformer, Bi-LSTM, Attention	69.09			
Mao et al., 2021 [79]*	Transformer	69.23	63.55		
Zhang and Li., 2023 [145]*	Transformer, GNN	69.6	62.3		
Song et al., 2022 [111]	Transformer, Contrastive Learning	69.74	67.25	40.94	
Yang et al., 2023 [135]	Transformer, Adapter, Contrastive Learning	69.81	65.70	38.75	62.51
Zhang et al., 2023 [146]*	Transformer - Generative LLM	69.93	71.90	40.05	
Hou et al., 2023 [41]	Transformer, GNN, Contrastive Learning	70.16	66.65	41.06	62.19
Tu et al., 2023 [115]	Transformer, GNN	70.43	66.19	40.51	
Li et al., 2023 [64]*	Transformer, GNN	71.03	61.77		
Lei et al., 2023 [62]	Transformer - Generative LLM	71.39	69.15	41.37	
Wei et al., 2023 [124]*	Transformer, GNN	71.60	63.92		
Li et al., 2022b [71]*	Transformer, Bi-LSTM	71.77	64.00		
Jiang et al., 2023 [51]	Transformer, KB		58.66	35.77	54.82
Lee and Choi., 2021 [59]	Transformer, GNN		65.36	39.24	61.91
Chen et al., 2023 [12]	Transformer, GRU		66.08	39.48	
Zhao et al., 2022 [147]	Transformer, GRU, Attention		65.37	40.09	
Li et al., 2020b [67]	Transformer		61.86	35.92	
Sun et al., 2021 [112]	Transformer, GNN, Bi-LSTM		64.22	36.38	
Kim et al., 2020 [55]	Transformer				59.20

6.1 Benchmark of ERC Works

Several authors resorted to gated neural networks, which can capture dependencies between words and utterances. This effort led to high reported results on the benchmark datasets. Some authors presented works using graph neural networks and the performances obtained are comparable to the ones obtained with gated neural networks. The best performances, however, were yielded when using transformers or transformer-based models, that better capture dependencies in long utterances, combined with the aforementioned state-of-the-art deep gated and graph-based network architectures for context modelling. This may reflect the promising role that transformers and pre-trained transformer-based language models play in Natural Language Processing and Emotion Recognition in Conversations and the suitability of recurrent gated and graph-based neural network architectures, as elaborated in previous sections.

Table 8: Summary of publications on Emotion Recognition in Conversations, reporting the methods used along with their performance.

Author, Year	Methods	Dataset, Metric
	Transformer	Friends, w-F1
Huang et al., 2019 [47]	Transformer	80.8
	GRU	Friends, w-A
Deep et al., 2019 [17]	Bi-GRU	75.94
	Transformer	
Ma et al., 2021 [76]	Transformer, Bi-GRU, Hierarchical, Attention	78.2
Jiang et al., 2020 [52]	Transformer, Bi-GRU, Hierarchical, Attention	84.1
	LSTM	EC, m-F1
González et al., 2019 [32]	Bi-LSTM, Attention	73.40
Boucekif et al., 2019 [6]	Bi-LSTM, Bi-GRU	74.5
Zhong et al., 2019 [148]	Bi-LSTM	74.63
Ge et al., 2019 [29]	LSTM, CNN, Attention	75.42
Ma et al., 2019 [77]	Bi-LSTM, Attention	75.57
Lee et al., 2019 [61]	Bi-GRU	75.81
Ragheb et al., 2019 [102]	Bi-LSTM	75.82
Li et al., 2019 [63]	Bi-GRU, Bi-LSTM, Attention, XGBoost [13]	75.88
Agrawal et al., 2019 [1]	LSTM, GRU, Attention	77.65
	Transformer	
Xiao et al., 2019 [132]	Transformer	76.08
Winata et al., 2019 [128]	Transformer, Hierarchical, LSTM	76.77
Huang et al., 2019 [46]	Transformer, LSTM, Hierarchical, Attention	77.09

7 ERC Challenges Revisited

Practically all works leveraged the information of preceding and sometimes also subsequent [65] utterances, resorting to gated or graph neural networks for context modelling of the utterances that were represented by embeddings from fine-tuned pre-trained language models. Another viable way to perform context modelling is to feed several appended utterances to the pre-trained language model [91]. For speaker specific modelling, also gated [78], graph [31] neural networks and a combination of both [108] architectures were used. Emotion dynamics modelling was less explored. One work considered a GRU to model the emotion dynamics of each party [78]. Some works considered a knowledge base [149] [30] [65] to aid in interpreting the meaning behind commonsense knowledge. However, such knowledge bases are not specific for emotions, which is an extension to consider. The majority of the works resorted to fine-tuning large pre-trained language models to obtain embeddings, which also aids in capturing the meaning behind commonsense knowledge expressions and informal language. Since most benchmark datasets provide a label for each utterance, guiding the models towards classifying emotions per utterance, there are still plenty of research opportunities with regards to real time ERC. The same applies to recognizing emotion causes. Regarding different taxonomies, as benchmarking is made on each dataset separately, there are few incentives to match emotions from one dataset to another, which could be a promising practice to consider. Concerning multilingual ERC, the collection and emotion annotation of multilingual datasets is encouraged, and has become more feasible with the advent of multilingual platforms for chat. Interpretability is still a challenge since most works focus on performance rather than explainability.

8 Conclusion

Research in Emotion Recognition in Conversations is advancing at a high pace and novel application scenarios pose new challenges and opportunities. This survey introduced and elaborated on the challenges pertaining to ERC. Many pipeline processes, from annotation to classification, need to be carefully considered: from leveraging the conversational context, speaker and emotion dynamics modelling, interpreting common sense expressions, informal language and sarcasm, addressing the challenges of real time ERC, recognizing emotion causes, multilingual ERC, different taxonomies to improving interpretability of the models. This survey went on to provide a description of the emotion taxonomies, benchmark datasets, descriptions of the most prominent works in ERC, with explanations of the Deep Learning architectures employed and advisable ERC practices towards better frameworks, elaborating on methods to deal with

subjectivity in annotations and modelling and methods to deal with the typically unbalanced ERC datasets. Finally, the survey presented systematic review tables comparing several works regarding the methods used and their performance.

The key takeaways put forward in this survey are now emphasized. Most datasets are unbalanced, motivating the need to leverage techniques and use appropriate performance metrics to address this unbalance. Further exploring mixed emotions with multi label datasets and classifiers is also an aspect to consider. Regarding subjectivity uncertainty in annotations, there are benefits in using inter-annotator (dis)agreement measures to weight or filter annotator’s opinions, to incorporate these measures as additional information to the classifiers and to consider soft label distributions per sample. Concerning deep learning classifier architectures, transformer-based language models play a promising role in Natural Language Processing and Emotion Recognition in Conversations and the most suitable network architectures for the task are gated and graph-based neural networks. ERC in a Generative Framework leveraging LLMs is also promising. Real time ERC, recognizing emotion causes, dealing with different taxonomies across datasets and multilingual ERC remain challenging.

Although research in Emotion Recognition in Conversations has come a long way, there is still much room for improvement, as it can be seen by the performance of the classifiers on the benchmark datasets and the several unexplored directions put forward in this section. While this survey described how current work has addressed several challenges, it also pointed out the opportunities that partly or fully unaddressed challenges constitute.

Finally, important ethical aspects pertaining to Emotion Recognition are now presented. These aspects are, for example and not limited to, whether an Emotion Recognition module should be developed or used for a certain purpose, which data to collect and the subjects behind the data, diversity and inclusiveness, privacy and control, and possible biases and misuses of the application [85]. Research in these directions will benefit the community with better Emotion Recognition in Conversation modules for current and novel applications.

9 Acknowledgments

This work was supported by Fundação para a Ciência e a Tecnologia (FCT), through Portuguese national funds, Ref. UIDB/50021/2020, DOI: 10.54499/UIDB/50021/2020 and Ref. UI/BD/154561/2022 and the Portuguese Recovery and Resilience Plan through project C645008882-00000055 (Responsible.AI). DeCLaRe Lab made a list of pointers to works on Emotion Recognition in Conversations that were featured in this survey, publicly available on its Github. Deep Learning TikZ images were based on contributions from Mark Wibrow, user121799 and J. Leon V on StackExchange and Renato Negrinho on Github.

References

- [1] Parag Agrawal and Anshuman Suri. NELEC at SemEval-2019 task 3: Think twice before going deep. In *Proceedings of the 13th International Workshop on Semantic Evaluation*, pages 266–271, Minneapolis, Minnesota, USA, June 2019. Association for Computational Linguistics.
- [2] Dzmitry Bahdanau, Kyunghyun Cho, and Yoshua Bengio. Neural machine translation by jointly learning to align and translate. *arXiv preprint arXiv:1409.0473*, 2014.
- [3] Oana Bălan, Gabriela Moise, Livia Petrescu, Alin Moldoveanu, Marius Leordeanu, and Florica Moldoveanu. Emotion classification based on biophysical signals and machine learning techniques. *Symmetry*, 12(1):21, 2019.
- [4] Raul Berrios, Peter Totterdell, and Stephen Kellett. Eliciting mixed emotions: a meta-analysis comparing models, types, and measures. *Frontiers in psychology*, 6:428, 2015.
- [5] Antoine Bosselut, Hannah Rashkin, Maarten Sap, Chaitanya Malaviya, Asli Celikyilmaz, and Yejin Choi. COMET: Commonsense transformers for automatic knowledge graph construction. In *Proceedings of the 57th Annual Meeting of the Association for Computational Linguistics*, pages 4762–4779, Florence, Italy, July 2019. Association for Computational Linguistics.
- [6] Abdessalam Boucekif, Praveen Joshi, Latifa Boucekif, and Haithem Afli. Epita-adapt at semeval-2019 task 3: Detecting emotions in textual conversations using deep learning models combination. In *Proceedings of the 13th International Workshop on Semantic Evaluation*, pages 215–219, 2019.
- [7] Tom Brown, Benjamin Mann, Nick Ryder, Melanie Subbiah, Jared D Kaplan, Prafulla Dhariwal, Arvind Neelakantan, Pranav Shyam, Girish Sastry, Amanda Askell, et al. Language models are few-shot learners. *Advances in neural information processing systems*, 33:1877–1901, 2020.
- [8] Carlos Busso, Murtaza Bulut, Chi-Chun Lee, Abe Kazemzadeh, Emily Mower, Samuel Kim, Jeannette N Chang, Sungbok Lee, and Shrikanth S Narayanan. Iemocap: Interactive emotional dyadic motion capture database. *Language resources and evaluation*, 42(4):335–359, 2008.

- [9] Emile Chapuis, Pierre Colombo, Matteo Manica, Matthieu Labeau, and Chloé Clavel. Hierarchical pre-training for sequence labelling in spoken dialog. In *Findings of the Association for Computational Linguistics: EMNLP 2020*, pages 2636–2648, Online, November 2020. Association for Computational Linguistics.
- [10] Ankush Chatterjee, Kedhar Nath Narahari, Meghana Joshi, and Puneet Agrawal. Semeval-2019 task 3: Emotion-contextual emotion detection in text. In *Proceedings of the 13th International Workshop on Semantic Evaluation*, pages 39–48, 2019.
- [11] Nitesh V Chawla, Kevin W Bowyer, Lawrence O Hall, and W Philip Kegelmeyer. Smote: synthetic minority over-sampling technique. *Journal of artificial intelligence research*, 16:321–357, 2002.
- [12] Jiawei Chen, Peijie Huang, Guotai Huang, Qianer Li, and Yuhong Xu. Sdtn: Speaker dynamics tracking network for emotion recognition in conversation. In *ICASSP 2023 - 2023 IEEE International Conference on Acoustics, Speech and Signal Processing (ICASSP)*, pages 1–5, 2023.
- [13] Tianqi Chen and Carlos Guestrin. Xgboost: A scalable tree boosting system. In *Proceedings of the 22nd acm sigkdd international conference on knowledge discovery and data mining*, pages 785–794, 2016.
- [14] Kyunghyun Cho, Bart van Merriënboer, Caglar Gulcehre, Dzmitry Bahdanau, Fethi Bougares, Holger Schwenk, and Yoshua Bengio. Learning phrase representations using RNN encoder–decoder for statistical machine translation. In *Proceedings of the 2014 Conference on Empirical Methods in Natural Language Processing (EMNLP)*, pages 1724–1734, Doha, Qatar, October 2014. Association for Computational Linguistics.
- [15] Zihang Dai, Zhilin Yang, Yiming Yang, Jaime Carbonell, Quoc Le, and Ruslan Salakhutdinov. Transformer-XL: Attentive language models beyond a fixed-length context. In *Proceedings of the 57th Annual Meeting of the Association for Computational Linguistics*, pages 2978–2988, Florence, Italy, July 2019. Association for Computational Linguistics.
- [16] António Damásio. *Sentir & Saber - A Caminho da Consciência*. Temas & Debates, 2020.
- [17] Kumar Shikhar Deep, Asif Ekbal, and Pushpak Bhattacharyya. A deep neural framework for contextual affect detection. In *International Conference on Neural Information Processing*, pages 398–409. Springer, 2019.
- [18] Dorottya Demszky, Dana Movshovitz-Attias, Jeongwoo Ko, Alan Cowen, Gaurav Nemade, and Sujith Ravi. GoEmotions: A dataset of fine-grained emotions. In *Proceedings of the 58th Annual Meeting of the Association for Computational Linguistics*, pages 4040–4054, Online, July 2020. Association for Computational Linguistics.
- [19] Jiawen Deng and Fuji Ren. A survey of textual emotion recognition and its challenges. *IEEE Transactions on Affective Computing*, 2021.
- [20] Jacob Devlin, Ming-Wei Chang, Kenton Lee, and Kristina Toutanova. BERT: Pre-training of deep bidirectional transformers for language understanding. In *Proceedings of the 2019 Conference of the North American Chapter of the Association for Computational Linguistics: Human Language Technologies, Volume 1 (Long and Short Papers)*, pages 4171–4186, Minneapolis, Minnesota, June 2019. Association for Computational Linguistics.
- [21] Kodati Dheeraj and Tene Ramakrishnu. Negative emotions detection on online mental-health related patients texts using the deep learning with mha-bcnn model. *Expert Systems with Applications*, 182:115–265, 2021.
- [22] Paul Ekman. Basic emotions. *Handbook of cognition and emotion*, 98(45-60):16, 1999.
- [23] Jeffrey L Elman. Distributed representations, simple recurrent networks, and grammatical structure. *Machine learning*, 7(2):195–225, 1991.
- [24] Florian Eyben, Martin Wöllmer, Alex Graves, Björn Schuller, Ellen Douglas-Cowie, and Roddy Cowie. On-line emotion recognition in a 3-d activation-valence-time continuum using acoustic and linguistic cues. *Journal on Multimodal User Interfaces*, 3(1):7–19, 2010.
- [25] Florian Eyben, Martin Wöllmer, and Björn Schuller. A multitask approach to continuous five-dimensional affect sensing in natural speech. *ACM Transactions on Interactive Intelligent Systems (TiiS)*, 2(1):1–29, 2012.
- [26] Joseph L Fleiss. Measuring nominal scale agreement among many raters. *Psychological bulletin*, 76(5):378, 1971.
- [27] Yao Fu, Shaoyang Yuan, Chi Zhang, and Juan Cao. Emotion recognition in conversations: A survey focusing on context, speaker dependencies, and fusion methods. *Electronics*, 12(22), 2023.
- [28] Tianyu Gao, Xingcheng Yao, and Danqi Chen. SimCSE: Simple contrastive learning of sentence embeddings. In *Proceedings of the 2021 Conference on Empirical Methods in Natural Language Processing*, pages 6894–6910, Online and Punta Cana, Dominican Republic, November 2021. Association for Computational Linguistics.
- [29] Suyu Ge, Tao Qi, Chuhan Wu, and Yongfeng Huang. Thu_ngn at semeval-2019 task 3: dialog emotion classification using attentional lstm-cnn. In *Proceedings of the 13th International Workshop on Semantic Evaluation*, pages 340–344, 2019.

- [30] Deepanway Ghosal, Navonil Majumder, Alexander Gelbukh, Rada Mihalcea, and Soujanya Poria. COSMIC: COMmonSense knowledge for eMotion identification in conversations. In *Findings of the Association for Computational Linguistics: EMNLP 2020*, pages 2470–2481, Online, November 2020. Association for Computational Linguistics.
- [31] Deepanway Ghosal, Navonil Majumder, Soujanya Poria, Niyati Chhaya, and Alexander Gelbukh. DialogueGCN: A graph convolutional neural network for emotion recognition in conversation. In *Proceedings of the 2019 Conference on Empirical Methods in Natural Language Processing and the 9th International Joint Conference on Natural Language Processing (EMNLP-IJCNLP)*, pages 154–164, Hong Kong, China, November 2019. Association for Computational Linguistics.
- [32] Ana Valeria González, Victor Petré Bach Hansen, Joachim Bingel, and Anders Søgaard. Coastal at semeval-2019 task 3: Affect classification in dialogue using attentive bilstms. In *Proceedings of the 13th International Workshop on Semantic Evaluation*, pages 169–174, 2019.
- [33] Alex Graves, Santiago Fernández, and Jürgen Schmidhuber. Bidirectional lstm networks for improved phoneme classification and recognition. In *International conference on artificial neural networks*, pages 799–804. Springer, 2005.
- [34] Michael Grimm and Kristian Kroschel. Evaluation of natural emotions using self assessment manikins. In *IEEE Workshop on Automatic Speech Recognition and Understanding, 2005.*, pages 381–385. IEEE, 2005.
- [35] Simone Hantke, Erik Marchi, and Björn Schuller. Introducing the weighted trustability evaluator for crowdsourcing exemplified by speaker likability classification. In *Proceedings of the Tenth International Conference on Language Resources and Evaluation (LREC’16)*, pages 2156–2161, 2016.
- [36] Devamanyu Hazarika, Soujanya Poria, Rada Mihalcea, Erik Cambria, and Roger Zimmermann. Icon: interactive conversational memory network for multimodal emotion detection. In *Proceedings of the 2018 conference on empirical methods in natural language processing*, pages 2594–2604, 2018.
- [37] Devamanyu Hazarika, Soujanya Poria, Amir Zadeh, Erik Cambria, Louis-Philippe Morency, and Roger Zimmermann. Conversational memory network for emotion recognition in dyadic dialogue videos. In *Proceedings of the conference. Association for Computational Linguistics. North American Chapter. Meeting*, volume 2018, page 2122. NIH Public Access, 2018.
- [38] Devamanyu Hazarika, Soujanya Poria, Roger Zimmermann, and Rada Mihalcea. Conversational transfer learning for emotion recognition. *Information Fusion*, 65:1–12, 2021.
- [39] Jonathan Herzig, Guy Feigenblat, Michal Shmueli-Scheuer, David Konopnicki, Anat Rafaeli, Daniel Altman, and David Spivak. Classifying emotions in customer support dialogues in social media. In *Proceedings of the 17th Annual Meeting of the Special Interest Group on Discourse and Dialogue*, pages 64–73, Los Angeles, September 2016. Association for Computational Linguistics.
- [40] Sepp Hochreiter and Jürgen Schmidhuber. Long short-term memory. *Neural computation*, 9(8):1735–1780, 1997.
- [41] Guiyang Hou, Yongliang Shen, Wenqi Zhang, Wei Xue, and Weiming Lu. Enhancing emotion recognition in conversation via multi-view feature alignment and memorization. In Houda Bouamor, Juan Pino, and Kalika Bali, editors, *Findings of the Association for Computational Linguistics: EMNLP 2023*, pages 12651–12663, Singapore, December 2023. Association for Computational Linguistics.
- [42] Chao-Chun Hsu, Sheng-Yeh Chen, Chuan-Chun Kuo, Ting-Hao Huang, and Lun-Wei Ku. EmotionLines: An emotion corpus of multi-party conversations. In *Proceedings of the Eleventh International Conference on Language Resources and Evaluation (LREC 2018)*, Miyazaki, Japan, May 2018. European Language Resources Association (ELRA).
- [43] Dou Hu, Xiaolong Hou, Lingwei Wei, Lianxin Jiang, and Yang Mo. Mm-dfn: Multimodal dynamic fusion network for emotion recognition in conversations. In *ICASSP 2022-2022 IEEE International Conference on Acoustics, Speech and Signal Processing (ICASSP)*, pages 7037–7041. IEEE, 2022.
- [44] Dou Hu, Lingwei Wei, and Xiaoyong Huai. DialogueCRN: Contextual reasoning networks for emotion recognition in conversations. In *Proceedings of the 59th Annual Meeting of the Association for Computational Linguistics and the 11th International Joint Conference on Natural Language Processing (Volume 1: Long Papers)*, pages 7042–7052, Online, August 2021. Association for Computational Linguistics.
- [45] Jingwen Hu, Yuchen Liu, Jinming Zhao, and Qin Jin. MMGCN: Multimodal fusion via deep graph convolution network for emotion recognition in conversation. In *Proceedings of the 59th Annual Meeting of the Association for Computational Linguistics and the 11th International Joint Conference on Natural Language Processing (Volume 1: Long Papers)*, pages 5666–5675, Online, August 2021. Association for Computational Linguistics.

- [46] Chenyang Huang, Amine Trabelsi, and Osmar Zaiane. ANA at SemEval-2019 task 3: Contextual emotion detection in conversations through hierarchical LSTMs and BERT. In *Proceedings of the 13th International Workshop on Semantic Evaluation*, pages 49–53, Minneapolis, Minnesota, USA, June 2019. Association for Computational Linguistics.
- [47] Yen-Hao Huang, Ssu-Rui Lee, Mau-Yun Ma, Yi-Hsin Chen, Ya-Wen Yu, and Yi-Shin Chen. Emotionx-idea: Emotion bert—an affectional model for conversation. *arXiv preprint arXiv:1908.06264*, 2019.
- [48] Taichi Ishiwatari, Yuki Yasuda, Taro Miyazaki, and Jun Goto. Relation-aware graph attention networks with relational position encodings for emotion recognition in conversations. In *Proceedings of the 2020 Conference on Empirical Methods in Natural Language Processing (EMNLP)*, pages 7360–7370, 2020.
- [49] Sarthak Jain and Byron C. Wallace. Attention is not Explanation. In *Proceedings of the 2019 Conference of the North American Chapter of the Association for Computational Linguistics: Human Language Technologies, Volume 1 (Long and Short Papers)*, pages 3543–3556, Minneapolis, Minnesota, June 2019. Association for Computational Linguistics.
- [50] DongJin Jeong and JinYeong Bak. Conversational emotion-cause pair extraction with guided mixture of experts. In Andreas Vlachos and Isabelle Augenstein, editors, *Proceedings of the 17th Conference of the European Chapter of the Association for Computational Linguistics*, pages 3288–3298, Dubrovnik, Croatia, May 2023. Association for Computational Linguistics.
- [51] Dazhi Jiang, Runguo Wei, Jintao Wen, Geng Tu, and Erik Cambria. Automl-emo: Automatic knowledge selection using congruent effect for emotion identification in conversations. *IEEE Transactions on Affective Computing*, 14(3):1845–1856, 2023.
- [52] Ting Jiang, Bing Xu, Tiejun Zhao, and Sheng Li. Can-gru: A hierarchical model for emotion recognition in dialogue. In *China National Conference on Chinese Computational Linguistics*, pages 374–387. Springer, 2020.
- [53] Wenxiang Jiao, Michael Lyu, and Irwin King. Real-time emotion recognition via attention gated hierarchical memory network. In *Proceedings of the AAAI Conference on Artificial Intelligence*, volume 34, pages 8002–8009, 2020.
- [54] Yujin Kang and Yoon-Sik Cho. Directed acyclic graphs with prototypical networks for few-shot emotion recognition in conversation. *IEEE Access*, 11:117633–117642, 2023.
- [55] Jonggu Kim, Hyeonmok Ko, Seoha Song, Saebom Jang, and Jiyeon Hong. Contextual augmentation of pretrained language models for emotion recognition in conversations. In *Proceedings of the Third Workshop on Computational Modeling of People’s Opinions, Personality, and Emotion’s in Social Media*, pages 64–73, 2020.
- [56] Shivani Kumar, Ramaneswaran S, Md Akhtar, and Tanmoy Chakraborty. From multilingual complexity to emotional clarity: Leveraging commonsense to unveil emotions in code-mixed dialogues. In Houda Bouamor, Juan Pino, and Kalika Bali, editors, *Proceedings of the 2023 Conference on Empirical Methods in Natural Language Processing*, pages 9638–9652, Singapore, December 2023. Association for Computational Linguistics.
- [57] John D. Lafferty, Andrew McCallum, and Fernando C. N. Pereira. Conditional random fields: Probabilistic models for segmenting and labeling sequence data. In *Proceedings of the Eighteenth International Conference on Machine Learning, ICML ’01*, page 282–289, San Francisco, CA, USA, 2001. Morgan Kaufmann Publishers Inc.
- [58] Helang Lai, Hongying Chen, and Shuangyan Wu. Different contextual window sizes based rnns for multimodal emotion detection in interactive conversations. *IEEE Access*, 8:119516–119526, 2020.
- [59] Bongseok Lee and Yong Suk Choi. Graph based network with contextualized representations of turns in dialogue. In *Proceedings of the 2021 Conference on Empirical Methods in Natural Language Processing*, pages 443–455, Online and Punta Cana, Dominican Republic, November 2021. Association for Computational Linguistics.
- [60] Chi-Chun Lee, Carlos Busso, Sungbok Lee, and Shrikanth S Narayanan. Modeling mutual influence of interlocutor emotion states in dyadic spoken interactions. In *Tenth Annual Conference of the International Speech Communication Association*, 2009.
- [61] Yoonhyung Lee, Yanghoon Kim, and Kyomin Jung. Milab at semeval-2019 task 3: Multi-view turn-by-turn model for context-aware sentiment analysis. In *Proceedings of the 13th International Workshop on Semantic Evaluation*, pages 256–260, 2019.
- [62] Shanglin Lei, Guanting Dong, Xiaoping Wang, Keheng Wang, and Sirui Wang. Instructorc: Reforming emotion recognition in conversation with a retrieval multi-task llms framework. *arXiv preprint arXiv:2309.11911*, 2023.
- [63] Dawei Li, Jin Wang, and Xuejie Zhang. Yun-hpcc at semeval-2019 task 3: Multi-step ensemble neural network for sentiment analysis in textual conversation. In *Proceedings of the 13th International Workshop on Semantic Evaluation*, pages 360–364, 2019.

- [64] Dongyuan Li, Yusong Wang, Kotaro Funakoshi, and Manabu Okumura. Joyful: Joint modality fusion and graph contrastive learning for multimodal emotion recognition. In Houda Bouamor, Juan Pino, and Kalika Bali, editors, *Proceedings of the 2023 Conference on Empirical Methods in Natural Language Processing*, pages 16051–16069, Singapore, December 2023. Association for Computational Linguistics.
- [65] Jiangnan Li, Zheng Lin, Peng Fu, and Weiping Wang. Past, present, and future: Conversational emotion recognition through structural modeling of psychological knowledge. In *Findings of the Association for Computational Linguistics: EMNLP 2021*, pages 1204–1214, 2021.
- [66] Jingye Li, Donghong Ji, Fei Li, Meishan Zhang, and Yijiang Liu. Hitrans: A transformer-based context- and speaker-sensitive model for emotion detection in conversations. In *Proceedings of the 28th International Conference on Computational Linguistics*, pages 4190–4200, 2020.
- [67] Qingbiao Li, Chunhua Wu, Zhe Wang, and Kangfeng Zheng. Hierarchical transformer network for utterance-level emotion recognition. *Applied Sciences*, 10(13):4447, 2020.
- [68] Qiuchi Li, Dimitris Gkoumas, Alessandro Sordani, Jian-Yun Nie, and Massimo Melucci. Quantum-inspired neural network for conversational emotion recognition. In *Proceedings of the AAAI Conference on Artificial Intelligence*, volume 35, pages 13270–13278, 2021.
- [69] Wei Li, Wei Shao, Shaoxiong Ji, and Erik Cambria. Bieru: Bidirectional emotional recurrent unit for conversational sentiment analysis. *Neurocomput.*, 467(C):73–82, jan 2022.
- [70] Yanran Li, Hui Su, Xiaoyu Shen, Wenjie Li, Ziqiang Cao, and Shuzi Niu. DailyDialog: A manually labelled multi-turn dialogue dataset. In *Proceedings of the Eighth International Joint Conference on Natural Language Processing (Volume 1: Long Papers)*, pages 986–995, Taipei, Taiwan, November 2017. Asian Federation of Natural Language Processing.
- [71] Zaijing Li, Fengxiao Tang, Ming Zhao, and Yusen Zhu. EmoCaps: Emotion capsule based model for conversational emotion recognition. In *Findings of the Association for Computational Linguistics: ACL 2022*, pages 1610–1618, Dublin, Ireland, May 2022. Association for Computational Linguistics.
- [72] Chen Liang, Jing Xu, Yangkun Lin, Chong Yang, and Yongliang Wang. S+PAGE: A speaker and position-aware graph neural network model for emotion recognition in conversation. In *Proceedings of the 2nd Conference of the Asia-Pacific Chapter of the Association for Computational Linguistics and the 12th International Joint Conference on Natural Language Processing (Volume 1: Long Papers)*, pages 148–157, Online only, November 2022. Association for Computational Linguistics.
- [73] Yinhan Liu, Myle Ott, Naman Goyal, Jingfei Du, Mandar Joshi, Danqi Chen, Omer Levy, Mike Lewis, Luke Zettlemoyer, and Veselin Stoyanov. Roberta: A robustly optimized bert pretraining approach. *arXiv preprint arXiv:1907.11692*, 2019.
- [74] Yuchen Liu, Jinming Zhao, Jingwen Hu, Ruichen Li, and Qin Jin. DialogueEIN: Emotion interaction network for dialogue affective analysis. In Nicoletta Calzolari, Chu-Ren Huang, Hansaem Kim, James Pustejovsky, Leo Wanner, Key-Sun Choi, Pum-Mo Ryu, Hsin-Hsi Chen, Lucia Donatelli, Heng Ji, Sadao Kurohashi, Patrizia Paggio, Nianwen Xue, Seokhwan Kim, Younggyun Hahm, Zhong He, Tony Kyungil Lee, Enrico Santus, Francis Bond, and Seung-Hoon Na, editors, *Proceedings of the 29th International Conference on Computational Linguistics*, pages 684–693, Gyeongju, Republic of Korea, October 2022. International Committee on Computational Linguistics.
- [75] Xin Lu, Yanyan Zhao, Yang Wu, Yijian Tian, Huipeng Chen, and Bing Qin. An iterative emotion interaction network for emotion recognition in conversations. In *Proceedings of the 28th International Conference on Computational Linguistics*, pages 4078–4088, 2020.
- [76] Hui Ma, Jian Wang, Lingfei Qian, and Hongfei Lin. Han-regru: hierarchical attention network with residual gated recurrent unit for emotion recognition in conversation. *Neural Computing and Applications*, 33(7):2685–2703, 2021.
- [77] Luyao Ma, Long Zhang, Wei Ye, and Wenhui Hu. Pkuse at semeval-2019 task 3: emotion detection with emotion-oriented neural attention network. In *Proceedings of the 13th International Workshop on Semantic Evaluation*, pages 287–291, 2019.
- [78] Navonil Majumder, Soujanya Poria, Devamanyu Hazarika, Rada Mihalcea, Alexander Gelbukh, and Erik Cambria. Dialoguernn: An attentive rnn for emotion detection in conversations. In *Proceedings of the AAAI Conference on Artificial Intelligence*, volume 33, pages 6818–6825, 2019.
- [79] Yuzhao Mao, Guang Liu, Xiaojie Wang, Weiguo Gao, and Xuan Li. DialogueTRM: Exploring multi-modal emotional dynamics in a conversation. In *Findings of the Association for Computational Linguistics: EMNLP 2021*, pages 2694–2704, Punta Cana, Dominican Republic, November 2021. Association for Computational Linguistics.

- [80] Mary L McHugh. Interrater reliability: the kappa statistic. *Biochemia medica*, 22(3):276–282, 2012.
- [81] Gary McKeown, Michel Valstar, Roddy Cowie, Maja Pantic, and Marc Schroder. The semaine database: Annotated multimodal records of emotionally colored conversations between a person and a limited agent. *IEEE transactions on affective computing*, 3(1):5–17, 2011.
- [82] Albert Mehrabian. *Basic Dimensions for a General Psychological Theory: Implications for Personality, Social, Environmental, and Developmental Studies*. Oelgeschlager, Gunn & Hain, Cambridge, 1980.
- [83] Tomas Mikolov, Kai Chen, Greg Corrado, and Jeffrey Dean. Efficient estimation of word representations in vector space. *arXiv preprint arXiv:1301.3781*, 2013.
- [84] Tomas Mikolov, Edouard Grave, Piotr Bojanowski, Christian Puhersch, and Armand Joulin. Advances in pre-training distributed word representations. In *Proceedings of the Eleventh International Conference on Language Resources and Evaluation (LREC 2018)*, Miyazaki, Japan, May 2018. European Language Resources Association (ELRA).
- [85] Saif M Mohammad. Ethics sheet for automatic emotion recognition and sentiment analysis. *Computational Linguistics*, 48(2):239–278, 2022.
- [86] Nang Su Lin Nwe, Yanan Wang, Jianming Wu, Gen Hattori, and Aye Thida. Analysis of utterance combinations for emotion recognition in conversation. In *Proceedings of the The 34th Annual Conference of the Japanese Society for Artificial Intelligence*, 2020.
- [87] David Olson. From utterance to text: The bias of language in speech and writing. *Harvard educational review*, 47(3):257–281, 1977.
- [88] Jaak Panksepp. *Affective neuroscience: The foundations of human and animal emotions*. Oxford university press, 2004.
- [89] Harris Partaourides, Kostantinos Papadamou, Nicolas Kourtellis, Ilias Leontiades, and Sotirios Chatzis. A self-attentive emotion recognition network. In *ICASSP 2020-2020 IEEE International Conference on Acoustics, Speech and Signal Processing (ICASSP)*, pages 7199–7203. IEEE, 2020.
- [90] Jeffrey Pennington, Richard Socher, and Christopher D Manning. Glove: Global vectors for word representation. In *Proceedings of the 2014 conference on empirical methoailys in natural language processing (EMNLP)*, pages 1532–1543, 2014.
- [91] Patrícia Pereira, Helena Moniz, Isabel Dias, and Joao Paulo Carvalho. Context-dependent embedding utterance representations for emotion recognition in conversations. In *Proceedings of the 13th Workshop on Computational Approaches to Subjectivity, Sentiment, & Social Media Analysis*, pages 228–236. Association for Computational Linguistics, 2023.
- [92] Matthew E. Peters, Mark Neumann, Mohit Iyyer, Matt Gardner, Christopher Clark, Kenton Lee, and Luke Zettlemoyer. Deep contextualized word representations. In *Proceedings of the 2018 Conference of the North American Chapter of the Association for Computational Linguistics: Human Language Technologies, Volume 1 (Long Papers)*, pages 2227–2237, New Orleans, Louisiana, June 2018. Association for Computational Linguistics.
- [93] Rosalind W Picard. *Affective computing*. MIT press, 2000.
- [94] Robert Plutchik. A psychoevolutionary theory of emotions. *Social Science Information*, 21(4-5):529–553, 1982.
- [95] Soujanya Poria, Erik Cambria, Devamanyu Hazarika, Navonil Majumder, Amir Zadeh, and Louis-Philippe Morency. Context-dependent sentiment analysis in user-generated videos. In *Proceedings of the 55th annual meeting of the association for computational linguistics (volume 1: Long papers)*, pages 873–883, 2017.
- [96] Soujanya Poria, Devamanyu Hazarika, Navonil Majumder, and Rada Mihalcea. Beneath the tip of the iceberg: Current challenges and new directions in sentiment analysis research. *IEEE Transactions on Affective Computing*, 14(1):108–132, 2023.
- [97] Soujanya Poria, Devamanyu Hazarika, Navonil Majumder, Gautam Naik, Erik Cambria, and Rada Mihalcea. MELD: A multimodal multi-party dataset for emotion recognition in conversations. In *Proceedings of the 57th Annual Meeting of the Association for Computational Linguistics*, pages 527–536, Florence, Italy, July 2019. Association for Computational Linguistics.
- [98] Soujanya Poria, Navonil Majumder, Devamanyu Hazarika, Deepanway Ghosal, Rishabh Bhardwaj, Samson Yu Bai Jian, Pengfei Hong, Romila Ghosh, Abhinaba Roy, Niyati Chhaya, et al. Recognizing emotion cause in conversations. *Cognitive Computation*, 13(5):1317–1332, 2021.
- [99] Soujanya Poria, Navonil Majumder, Rada Mihalcea, and Eduard Hovy. Emotion recognition in conversation: Research challenges, datasets, and recent advances. *IEEE Access*, 7:100943–100953, 2019.

- [100] Alec Radford, Karthik Narasimhan, Tim Salimans, Ilya Sutskever, et al. Improving language understanding by generative pre-training. *OpenAI blog*, 2018.
- [101] Alec Radford, Jeffrey Wu, Rewon Child, David Luan, Dario Amodei, Ilya Sutskever, et al. Language models are unsupervised multitask learners. *OpenAI blog*, 1(8):9, 2019.
- [102] Waleed Ragheb, Jérôme Azé, Sandra Bringay, and Maximilien Servajean. Lirmm-advance at semeval-2019 task 3: Attentive conversation modeling for emotion detection and classification. In *SemEval: Semantic Evaluation in NAACL-HLT*, pages 251–255, 2019.
- [103] Fabien Ringeval, Andreas Sonderegger, Juergen Sauer, and Denis Lalanne. Introducing the recola multimodal corpus of remote collaborative and affective interactions. In *2013 10th IEEE international conference and workshops on automatic face and gesture recognition (FG)*, pages 1–8. IEEE, 2013.
- [104] Georgios Rizos and Björn W Schuller. Average jane, where art thou?—recent avenues in efficient machine learning under subjectivity uncertainty. In *International Conference on Information Processing and Management of Uncertainty in Knowledge-Based Systems*, pages 42–55. Springer, 2020.
- [105] David E Rumelhart, Geoffrey E Hinton, and Ronald J Williams. Learning representations by back-propagating errors. *nature*, 323(6088):533–536, 1986.
- [106] James A Russell. A circumplex model of affect. *Journal of personality and social psychology*, 39(6):1161, 1980.
- [107] Weizhou Shen, Junqing Chen, Xiaojun Quan, and Zhixian Xie. Dialogxl: All-in-one xlnet for multi-party conversation emotion recognition. In *Proceedings of the AAAI Conference on Artificial Intelligence*, volume 35, pages 13789–13797, 2021.
- [108] Weizhou Shen, Siyue Wu, Yunyi Yang, and Xiaojun Quan. Directed acyclic graph network for conversational emotion recognition. In *Proceedings of the 59th Annual Meeting of the Association for Computational Linguistics and the 11th International Joint Conference on Natural Language Processing (Volume 1: Long Papers)*, pages 1551–1560, Online, August 2021. Association for Computational Linguistics.
- [109] Dongming Sheng, Dong Wang, Ying Shen, Haitao Zheng, and Haozhuang Liu. Summarize before aggregate: A global-to-local heterogeneous graph inference network for conversational emotion recognition. In *Proceedings of the 28th International Conference on Computational Linguistics*, pages 4153–4163, 2020.
- [110] Yunsheng Shi, Zhengjie Huang, Shikun Feng, Hui Zhong, Wenjing Wang, and Yu Sun. Masked label prediction: Unified message passing model for semi-supervised classification. In *Proceedings of the Thirtieth International Joint Conference on Artificial Intelligence, IJCAI-21*, pages 1548–1554. International Joint Conferences on Artificial Intelligence Organization, 8 2021. Main Track.
- [111] Xiaohui Song, Longtao Huang, Hui Xue, and Songlin Hu. Supervised prototypical contrastive learning for emotion recognition in conversation. In *Proceedings of the 2022 Conference on Empirical Methods in Natural Language Processing*, pages 5197–5206, Abu Dhabi, United Arab Emirates, December 2022. Association for Computational Linguistics.
- [112] Yang Sun, Nan Yu, and Guohong Fu. A discourse-aware graph neural network for emotion recognition in multi-party conversation. In *Findings of the Association for Computational Linguistics: EMNLP 2021*, pages 2949–2958, 2021.
- [113] Veronika Thost and Jie Chen. Directed acyclic graph neural networks. *arXiv preprint arXiv:2101.07965*, 2021.
- [114] Hugo Touvron, Thibaut Lavril, Gautier Izacard, Xavier Martinet, Marie-Anne Lachaux, Timothée Lacroix, Baptiste Rozière, Naman Goyal, Eric Hambro, Faisal Azhar, et al. Llama: Open and efficient foundation language models. *arXiv preprint arXiv:2302.13971*, 2023.
- [115] Geng Tu, Ran Jing, Bin Liang, Min Yang, Kam-Fai Wong, and Ruifeng Xu. A training-free debiasing framework with counterfactual reasoning for conversational emotion detection. In Houda Bouamor, Juan Pino, and Kalika Bali, editors, *Proceedings of the 2023 Conference on Empirical Methods in Natural Language Processing*, pages 15639–15650, Singapore, December 2023. Association for Computational Linguistics.
- [116] Geng Tu, Bin Liang, Dazhi Jiang, and Ruifeng Xu. Sentiment- emotion- and context-guided knowledge selection framework for emotion recognition in conversations. *IEEE Transactions on Affective Computing*, 14(3):1803–1816, 2023.
- [117] Geng Tu, Bin Liang, Ruibin Mao, Min Yang, and Ruifeng Xu. Context or knowledge is not always necessary: A contrastive learning framework for emotion recognition in conversations. In *Findings of the Association for Computational Linguistics: ACL 2023*, pages 14054–14067, Toronto, Canada, July 2023. Association for Computational Linguistics.

- [118] Geng Tu, Bin Liang, Bing Qin, Kam-Fai Wong, and Ruifeng Xu. An empirical study on multiple knowledge from ChatGPT for emotion recognition in conversations. In Houda Bouamor, Juan Pino, and Kalika Bali, editors, *Findings of the Association for Computational Linguistics: EMNLP 2023*, pages 12160–12173, Singapore, December 2023. Association for Computational Linguistics.
- [119] Alexandra N Uma, Tommaso Fornaciari, Dirk Hovy, Silviu Paun, Barbara Plank, and Massimo Poesio. Learning from disagreement: A survey. *Journal of Artificial Intelligence Research*, 72:1385–1470, 2021.
- [120] Ashish Vaswani, Noam Shazeer, Niki Parmar, Jakob Uszkoreit, Llion Jones, Aidan N Gomez, Łukasz Kaiser, and Illia Polosukhin. Attention is all you need. In *Advances in Neural Information Processing Systems*, volume 30. Curran Associates, Inc., 2017.
- [121] Fanfan Wang, Jianfei Yu, and Rui Xia. Generative emotion cause triplet extraction in conversations with commonsense knowledge. In Houda Bouamor, Juan Pino, and Kalika Bali, editors, *Findings of the Association for Computational Linguistics: EMNLP 2023*, pages 3952–3963, Singapore, December 2023. Association for Computational Linguistics.
- [122] Yan Wang, Jiayu Zhang, Jun Ma, Shaojun Wang, and Jing Xiao. Contextualized emotion recognition in conversation as sequence tagging. In *Proceedings of the 21th Annual Meeting of the Special Interest Group on Discourse and Dialogue*, pages 186–195, 2020.
- [123] Yaqing Wang, Quanming Yao, James T Kwok, and Lionel M Ni. Generalizing from a few examples: A survey on few-shot learning. *ACM Computing Surveys (CSUR)*, 53(3):1–34, 2020.
- [124] Jie Wei, Guanyu Hu, Luu Anh Tuan, Xinyu Yang, and Wenjing Zhu. Multi-scale receptive field graph model for emotion recognition in conversations. In *ICASSP 2023 - 2023 IEEE International Conference on Acoustics, Speech and Signal Processing (ICASSP)*, pages 1–5, 2023.
- [125] Paul J Werbos. Backpropagation through time: what it does and how to do it. *Proceedings of the IEEE*, 78(10):1550–1560, 1990.
- [126] Sarah Wiegrefe and Yuval Pinter. Attention is not not explanation. In *Proceedings of the 2019 Conference on Empirical Methods in Natural Language Processing and the 9th International Joint Conference on Natural Language Processing (EMNLP-IJCNLP)*, pages 11–20, Hong Kong, China, November 2019. Association for Computational Linguistics.
- [127] Gloria Willcox. The feeling wheel: A tool for expanding awareness of emotions and increasing spontaneity and intimacy. *Transactional Analysis Journal*, 12(4):274–276, 1982.
- [128] Genta Indra Winata, Andrea Madotto, Zhaojiang Lin, Jamin Shin, Yan Xu, Peng Xu, and Pascale Fung. CAiRE_HKUST at SemEval-2019 task 3: Hierarchical attention for dialogue emotion classification. In *Proceedings of the 13th International Workshop on Semantic Evaluation*, pages 142–147, Minneapolis, Minnesota, USA, June 2019. Association for Computational Linguistics.
- [129] Martin Wöllmer, Angeliki Metallinou, Florian Eyben, Björn Schuller, and Shrikanth Narayanan. Context-sensitive multimodal emotion recognition from speech and facial expression using bidirectional lstm modeling. In *Proc. INTERSPEECH 2010, Makuhari, Japan*, pages 2362–2365, 2010.
- [130] Xiaolong Wu, Chang Feng, Mingxing Xu, Thomas Fang Zheng, and Askar Hamdulla. Dialoguepcn: Perception and cognition network for emotion recognition in conversations. *IEEE Access*, 11:141251–141260, 2023.
- [131] Zonghan Wu, Shirui Pan, Fengwen Chen, Guodong Long, Chengqi Zhang, and S Yu Philip. A comprehensive survey on graph neural networks. *IEEE transactions on neural networks and learning systems*, 32(1):4–24, 2020.
- [132] Joan Xiao. Figure eight at semeval-2019 task 3: ensemble of transfer learning methods for contextual emotion detection. In *Proceedings of the 13th International Workshop on Semantic Evaluation*, pages 220–224, 2019.
- [133] Yunhe Xie, Kailai Yang, Cheng-Jie Sun, Bingquan Liu, and Zhenzhou Ji. Knowledge-interactive network with sentiment polarity intensity-aware multi-task learning for emotion recognition in conversations. In *Findings of the Association for Computational Linguistics: EMNLP 2021*, pages 2879–2889, 2021.
- [134] Songlong Xing, Sijie Mai, and Haifeng Hu. Adapted dynamic memory network for emotion recognition in conversation. *IEEE Transactions on Affective Computing*, 13(3):1426–1439, 2022.
- [135] Kailai Yang, Tianlin Zhang, Hassan Alhuzali, and Sophia Ananiadou. Cluster-level contrastive learning for emotion recognition in conversations. *IEEE Transactions on Affective Computing*, 14(4):3269–3280, 2023.
- [136] Lin Yang, Yi Shen, Yue Mao, and Longjun Cai. Hybrid curriculum learning for emotion recognition in conversation. In *Proceedings of the AAAI Conference on Artificial Intelligence*, volume 36, pages 11595–11603, 2022.

- [137] Zhilin Yang, Zihang Dai, Yiming Yang, Jaime Carbonell, Russ R Salakhutdinov, and Quoc V Le. Xlnet: Generalized autoregressive pretraining for language understanding. *Advances in Neural Information Processing Systems*, 32, 2019.
- [138] Peter Zachar and Ralph D Ellis. *Categorical versus dimensional models of affect: a seminar on the theories of Panksepp and Russell*, volume 7. John Benjamins Publishing, 2012.
- [139] Sayyed M Zahiri and Jinho D Choi. Emotion detection on tv show transcripts with sequence-based convolutional neural networks. In *1st Workshop on Affective Content Analysis*, 2018.
- [140] Dong Zhang, Weisheng Zhang, Shoushan Li, Qiaoming Zhu, and Guodong Zhou. Modeling both intra-and inter-modal influence for real-time emotion detection in conversations. In *Proceedings of the 28th ACM International Conference on Multimedia*, pages 503–511, 2020.
- [141] Duzhen Zhang, Feilong Chen, and Xiuyi Chen. DualGATs: Dual graph attention networks for emotion recognition in conversations. In *Proceedings of the 61st Annual Meeting of the Association for Computational Linguistics (Volume 1: Long Papers)*, pages 7395–7408, Toronto, Canada, July 2023. Association for Computational Linguistics.
- [142] Duzhen Zhang, Xiuyi Chen, Shuang Xu, and Bo Xu. Knowledge aware emotion recognition in textual conversations via multi-task incremental transformer. In *Proceedings of the 28th International Conference on Computational Linguistics*, pages 4429–4440, 2020.
- [143] Haidong Zhang and Yekun Chai. Coin: Conversational interactive networks for emotion recognition in conversation. In *Proceedings of the Third Workshop on Multimodal Artificial Intelligence*, pages 12–18, 2021.
- [144] Mian Zhang, Xiabing Zhou, Wenliang Chen, and Min Zhang. Emotion recognition in conversation from variable-length context. In *ICASSP 2023 - 2023 IEEE International Conference on Acoustics, Speech and Signal Processing (ICASSP)*, pages 1–5, 2023.
- [145] Xiaoheng Zhang and Yang Li. A cross-modality context fusion and semantic refinement network for emotion recognition in conversation. In *Proceedings of the 61st Annual Meeting of the Association for Computational Linguistics (Volume 1: Long Papers)*, pages 13099–13110, Toronto, Canada, July 2023. Association for Computational Linguistics.
- [146] Yazhou Zhang, Mengyao Wang, Prayag Tiwari, Qiuchi Li, Benyou Wang, and Jing Qin. DialogueLLM: Context and emotion knowledge-tuned llama models for emotion recognition in conversations. *arXiv preprint arXiv:2310.11374*, 2023.
- [147] Weixiang Zhao, Yanyan Zhao, and Bing Qin. MuCDN: Mutual conversational detachment network for emotion recognition in multi-party conversations. In Nicoletta Calzolari, Chu-Ren Huang, Hansaem Kim, James Pustejovsky, Leo Wanner, Key-Sun Choi, Pum-Mo Ryu, Hsin-Hsi Chen, Lucia Donatelli, Heng Ji, Sadao Kurohashi, Patrizia Paggio, Nianwen Xue, Seokhwan Kim, Younggyun Hahm, Zhong He, Tony Kyungil Lee, Enrico Santus, Francis Bond, and Seung-Hoon Na, editors, *Proceedings of the 29th International Conference on Computational Linguistics*, pages 7020–7030, Gyeongju, Republic of Korea, October 2022. International Committee on Computational Linguistics.
- [148] Peixiang Zhong and Chunyan Miao. ntuer at SemEval-2019 task 3: Emotion classification with word and sentence representations in RCNN. *Proceedings of the 13th International Workshop on Semantic Evaluation*, pages 282–286, June 2019.
- [149] Peixiang Zhong, Di Wang, and Chunyan Miao. Knowledge-enriched transformer for emotion detection in textual conversations. In *Proceedings of the 2019 Conference on Empirical Methods in Natural Language Processing and the 9th International Joint Conference on Natural Language Processing (EMNLP-IJCNLP)*, pages 165–176, Hong Kong, China, November 2019. Association for Computational Linguistics.
- [150] Jie Zhou, Ganqu Cui, Shengding Hu, Zhengyan Zhang, Cheng Yang, Zhiyuan Liu, Lifeng Wang, Changcheng Li, and Maosong Sun. Graph neural networks: A review of methods and applications. *AI Open*, 1:57–81, 2020.
- [151] Lixing Zhu, Gabriele Pergola, Lin Gui, Deyu Zhou, and Yulan He. Topic-driven and knowledge-aware transformer for dialogue emotion detection. In *Proceedings of the 59th Annual Meeting of the Association for Computational Linguistics and the 11th International Joint Conference on Natural Language Processing (Volume 1: Long Papers)*, pages 1571–1582, Online, August 2021. Association for Computational Linguistics.