Multi-Agent Learning of Efficient Fulfilment and Routing Strategies in E-Commerce

Omkar Shelke
TCS Research
Mumbai, India
shelke.omkar@tcs.com

Pranavi Pathakota
TCS Research
Mumbai, India
p.pranavi@tcs.com

Anandsingh Chauhan
TCS Research
Mumbai, India
anandsingh.chauhan@tcs.com

Harshad Khadilkar
TCS Research, IIT Bombay
Mumbai, India
harshad.khadilkar@tcs.com
harshadk@iitb.ac.in

Hardik Meisheri
TCS Research
Mumbai, India
hardik.meisheri@gmail.com

Balaraman Ravindran
RBCDSAI, IIT Madras
India
ravi@cse.iitm.ac.in

Abstract

This paper presents an integrated algorithmic framework for minimising product delivery costs in e-commerce (known as the cost-to-serve or C2S). One of the major challenges in e-commerce is the large volume of spatio-temporally diverse orders from multiple customers, each of which has to be fulfilled from one of several warehouses using a fleet of vehicles. This results in two levels of decision-making: (i) selection of a fulfillment node for each order (including the option of deferral to a future time), and then (ii) routing of vehicles (each of which can carry multiple orders originating from the same warehouse). We propose an approach that combines graph neural networks and reinforcement learning to train the node selection and vehicle routing agents. We include real-world constraints such as warehouse inventory capacity, vehicle characteristics such as travel times, service times, carrying capacity, and customer constraints including time windows for delivery. The complexity of this problem arises from the fact that outcomes (rewards) are driven both by the fulfillment node mapping as well as the routing algorithms, and are spatio-temporally distributed. Our experiments show that this algorithmic pipeline outperforms pure heuristic policies.

1 Introduction

1.1 Motivation

Efficient operation of supply chains has been a problem area of interest for several decades (Holt et al., 1955; Haley and Higgins, 1973; Lambert and Cooper, 2000; Pathakota et al., 2023). However, it is still an open problem because of the constant disruptions in this field. In recent years, the advent of electronic commerce (abbreviated to ‘e-commerce’) has created new challenges. Specifically, the traditional retail supply chain network consisting of warehouses and stores has been abruptly extended to include individual customer delivery locations. The fulfillment of e-commerce orders

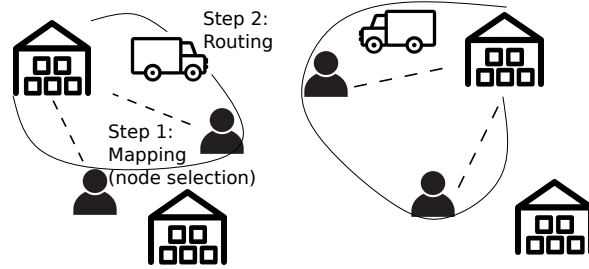

Figure 1: Illustration of e-commerce supply chain. The proposed algorithm learns to optimise the node selection and routing steps in an integrated fashion.

from a warehouse (‘fulfillment node’) requires two types of decisions; first, the selection of the fulfillment node from which the order is to be served, and second, the routing of vehicles from these nodes to a set of delivery locations. We define the total cost resulting from these decisions as the cost-to-serve, or C2S. Presently, these decisions are based on simple heuristics or rules – the nearest fulfillment node to every customer location is chosen, and then vehicles are sent to individual clusters of delivery locations. Our hypothesis in this paper is that the fulfillment node selection and vehicle routing are interdependent problems, and should be solved using an integrated approach. This improves the efficiency of the system both from resource utilization as well as turn around time. We show that a reinforcement learning algorithm trained to perform this task is able to outperform heuristics on several key performance indicators, and has the ability to adapt to changes in business objectives using weights on the individual reward terms.

1.2 Overview

We consider the scenario of last-mile delivery, where the goal of the retail e-commerce business is to serve dynamic customer orders with minimum operating cost. The portion of interest in the supply chain is shown by the schematic in Figure 1. An analysis of existing work in this area is given in Section 2. In this work, we assume that there is a single type of product which can be ordered in arbitrary quantity by every customer. The customers ‘pop up’ via a stochastic process in random locations and with demand drawn from a probability distribution. There is a minimum and maximum time corresponding to each order, within which delivery must happen. The warehouse locations are fixed, and the inventory of each warehouse is replenished using an external process (outside the scope of this work). The task of the fulfillment algorithm is to pick the warehouse for fulfilling each order, or to choose to defer the fulfillment to a future time. All orders being fulfilled in the present time step are then serviced by a vehicle routing agent, which takes into account vehicle capacity, travel times, and customer time windows. As described in Section 3, we consider multiple performance indicators, including proportion of successful deliveries, distance travelled, and vehicle capacity utilisation.

The resulting problem falls under the class of combinatorial optimisation (CO). While exact optimisation methods such as Mixed-Integer Linear Programming (MILP) perform well for static instances with fixed locations, they are less effective in the e-commerce context where situations are constantly changing. In Section 4, we use graph neural networks (GNN) to model the graph of customer and warehouse locations. GNNs can adapt to dynamic changes in nodes and can be combined with other learning techniques for downstream applications. We have found that by using the learned embeddings from graph training, a reinforcement learning (RL) policies are able to effectively assign fulfillment nodes and scheduling vehicle for routing. Section 6 shows that the resulting algorithm outperforms state-of-the-art heuristics on the various performance indicators. The contributions of this paper are as follows.

1. We formalise the fulfillment node selection and vehicle routing scenario as an integrated optimisation problem.
2. We propose an algorithm that uses GNN for modeling supply chain entities and RL based policies for the downstream tasks of fulfilment and vehicle routing.
3. We show that the proposed approach is able to outperform separately defined heuristics for fulfillment node selection and vehicle routing on a number of performance indicators, and for a variety of customer demand distributions.

2 Literature Review

This is an initial approach of integrating Cost-to-Serve (C2S) with routing of vehicles to a set of delivery locations. There is limited literature available on C2S, which usually adopts a process management perspective (Wilding, 2020). The term C2S involves recognizing that the cost drivers in a supply chain can vary for different products and sales channels (Cooper and Kaplan, 1997; Braithwaite and Samakh, 1998; Kaplan and Narayanan, 2001). In recent work, C2S was defined as a sequential decision-making problem and proposed a learning based approach to minimise it (Pathakota et al., 2023). However, the study did not include the vehicle routing problem (VRP) in the decision loop. VRP by itself is a well-known NP-hard problem in the area of combinatorial optimisation (Malandraki and Daskin, 1992a; Kallehauge, 2008a). The objective is to determine the optimal routes for one or more vehicles travelling to a specified set of customer locations. The problem is equivalent to the travelling salesman problem (TSP); if there is only one vehicle with no restrictions on its capacity, fuel, or range.

Capacitated VRP with time windows (CVRP-TW) is a constrained version of VRP that imposes a limit on the load carried by each vehicle, and the time required for each leg and service on the journey. It has been solved using the following approaches: heuristic or rule-based approach, linear programming (Malandraki and Daskin, 1992b; Kallehauge, 2008b), randomised search or meta-heuristics approach such as genetic algorithm (Baker and Ayechev, 2003), neighbourhood search, ant colony optimisation based approach (Bell and McMullen, 2004) and more recent learning-based approach such as attention mechanism and reinforcement learning (Nazari et al., 2018; Gupta et al., 2022) or a combination of reinforcement learning and satisfiability solver (Khadilkar, 2022). The heuristics approaches have performed excellent for the dynamic VRP problem, and are known to produce close to optimal results in the literature, the only drawback is to design a fix set of rules for specific instances while the learning based approaches can adapt to new instances quickly.

Recently, studies have recognised the importance of neighbourhood information in solving practical combinatorial optimisation problems. A popular approach is using Graph Neural Networks (GNNs). These methods have shown prominent results in wide range of applications ranging from recommender systems (Wu et al., 2022), traffic analysis (Wang et al., 2018), drug discovery (Gaudelet et al., 2021) to resource allocation (Liu et al., 2022). An end-to-end RL training with GNN is proposed in (Khalil et al., 2017), where a learning based greedy algorithm is learnt for combinatorial problems by training GNN and a Deep Q-Network (DQN) (Mnih et al., 2015) together. Their main focus is on learning an approximate greedy policy which can adapt to slight change in data distribution from training by adapting GNNs. In this paper, we focus on using GNN techniques to aid the learning agent by producing better embeddings over unseen graphs of customer demand.

The proposed learning based framework aims to provide an integrated solution to the single-product, multi-depot C2S, including VRP with the time window and capacity constraints. The problem formulation proposed in Sec. 3. The methodology is described in Sec. 4, including the graph embedding generation, training of RL agent for C2S, and the VRP heuristic used in this paper. Experiments and results are described in Sec. 6.

3 Problem Formulation

3.1 High-level description

The system described is a multi-objective optimization problem that aims to fulfill customer orders while minimizing the total cost incurred by the enterprise. The entities considered in this system are warehouses, vehicles, and customers. The cost of fulfilling an order is determined by several factors, including the distance traveled between various nodes, the capacity utilisation of the vehicles, and the number of customers served. The decision variables are the allocation of warehouses to customer orders, and the routes generated for the vehicles that deliver the orders. The characteristics are,

- At each time step, multiple customer orders may arise, each specifying a desired product quantity and a delivery time window. Failure to meet this window incurs a penalty.
- A reinforcement learning approach is employed to calculate vehicle routes, accounting for factors like vehicle capacity, travel times for each leg, and customer service times.
- Split deliveries is not allowed; entire product quantity must be served by allotted warehouse.

- Each vehicle adheres to a uniform maximum capacity constraint, consistent across all vehicles, and must return to its starting depot after serving customers on its route.
- Consistent speed across all vehicles results in travel times directly corresponding to distance.
- While each warehouse can dispatch an unlimited number of vehicles, the objective is to minimize the number of vehicles and the number of trips. Note that the proposed algorithm generalises to finite number of vehicles without change.
- Warehouses are replenished to their maximum capacity at fixed intervals, regardless of demand.

As orders are fulfilled, inventory is depleted from the chosen warehouse(s), leaving less available for future orders. The C2S policy must consider the geographical distribution of customers, balancing the overall end-to-end cost, while generating real-time optimal node fulfillment taking into account dynamic demand, location and time windows of the customers.

3.2 Mathematical formulation

In the description below, we formally specify the notation, constraints, and objectives of the problem.

Warehouse : We assume the existence of N warehouses indexed by $o = \{1, 2, \dots, N\}$, and denote the o^{th} warehouse location by $w_o = (w_{o,x}, w_{o,y})$. In this paper, we define a 2D grid on the range $[-100, 100] \times [-100, 100]$ and fix the location of 4 warehouses, one in the center of each quadrant of the grid. The warehouses stock a single type of product and their maximum inventory levels are identical. Each warehouse is restocked to its maximum level $P_o^{(\max)}$ after every $\frac{T}{2}$ time steps.

Customer demand generation: Each episode consists of τ time units. After every $T < \tau$ units¹, two sets of events occur. First, the warehouse inventory levels are set to their maximum levels (as described above). Second, a new set of customer demands is generated as follows.

- At every interval T , the number of unique customers is first generated from a uniform distribution ranging between 200 to 300 customers, which results in approximately 2500 customers over τ time units in an episode.
- The integer quantity demanded by the customer is chosen uniformly in the range $U[1, 10]$.
- If the current time is t , the minimum and maximum time window limits are generated using the formulae,

$$[\theta_{i,\min}, \theta_{i,\max}] = [t + U(0.2 T, 0.8 T), \theta_{i,\min} + U(0.1 T, 2 T)]$$

where $U(a, b)$ denotes the uniform distribution over the range (a, b) .

We denote customer i by the symbol c_i , and their characteristics are defined by the n-tuple $(m_i, x_i, y_i, t_i, \theta_{i,\min}, \theta_{i,\max})$ where m_i is the demand quantity of product, (x_i, y_i) is the location in a 2D grid, and t_i is the time step at which the customer is generated. Each customer has a stipulated time window $[\theta_{i,\min}, \theta_{i,\max}]$ during which order must be delivered.

Based on the problem specifications, we derive some important quantities from the point of view of the planning process. The Euclidean distance from warehouse o to customer i is denoted by $d_{o,i}$, and distance between two customers i, j by $d_{i,j}$. As soon as new customer demands are generated, the C2S agent is required to compute allocation decisions for all open demands (newly generated customers as well as ones deferred from previous time steps). The decisions consist of either allocation to a specific warehouse, or a deferral of the customer to the next time step.

Vehicle : We assume that vehicles can be spawned as required from each depot. Once a vehicle is spawned for the first time, it remains available for reuse for the rest of the episode. The vehicle characteristics are homogeneous, with maximum capacity Q and average speed v . We ensure that the demand generated for a single customer m_i cannot exceed the vehicle capacity Q , thus ensuring that multiple vehicles are not required for serving individual customers. The VRP agent described in Section 4 is used to compute the routes according to the decisions made by the C2S agent. Note that if a vehicle completes its assigned tour within T time units, it will be available to serve customers generated in the next set of demand generation. However, this is not a requirement imposed by the environment (trip may take longer than T time units).

Our vehicle routing approach considers constraints related to both capacity and time windows, resulting in the capacitated vehicle routing problem with time windows (CVRP-TW); and it assumes

¹In this paper, we use $T = 100$ and $\tau = 1000$.

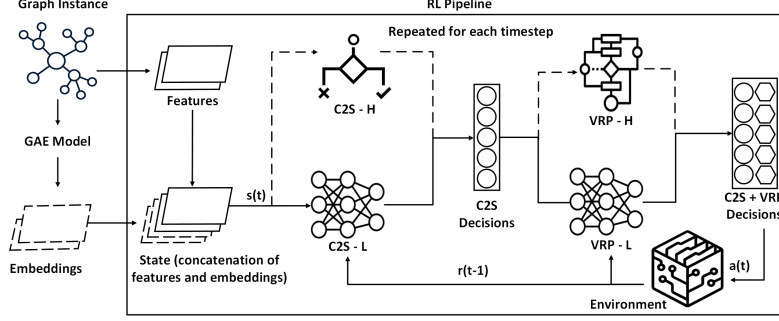

Figure 2: Proposed RL Framework

that customer-warehouse allocations are known at each time step. In our framework, the VRP agent described in section assumes that at timestep t , the C2S agent provides information about customer-warehouse pairs, where each customer's location is represented as $c_i^{(t)} = (c_{i,x}^{(t)}, c_{i,y}^{(t)})$, with a demanded load of m_i^t and service time windows $[T_{i,min}, T_{i,max}] \in \mathbb{R}^+$, with $T_{i,min} < T_{i,max}$, and where $i \in C$. Then the objective of the problem (Sultana et al., 2021) is to find the total distance J that minimises,

$$J = \min_{a_*, f_*, l_*} \left(\sum_{i,j,k} d_{i,j} a_{i,j,k} + \sum_{i,k} d_{o,i} f_{i,k} + \sum_{i,k} d_{o,i} l_{i,k} \right), \quad (1)$$

where $d_{i,j}$ is the distance from customer i to customer j , $d_{o,i}$ is the distance from origin (depot) to customer i , $a_{i,j,k}$ is an indicator variable which is 1 if vehicle k goes directly from customer i to customer j , $f_{i,k}$ is an indicator variable which is 1 if customer i is the first customer served by vehicle k , and $l_{i,k}$ is a similar indicator variable which is 1 if customer i is the last customer visited by vehicle k . Apart from constraints on $a_{i,j,k}$, $f_{i,k}$, and $l_{i,k}$ to take values from $\{0, 1\}$, the other constraints are defined below in brief. A detailed description can be found in (Sultana et al., 2021).

Every customer must be served within its time window. If vehicle k visits i at time $t_{i,k}$, then

$$T_{i,min} \leq t_{i,k} \leq T_{i,max}, \text{ if } f_{i,k} = 1 \text{ or } \exists j \text{ s.t. } a_{j,i,k} = 1 \quad (2)$$

The total load served by a vehicle must be at most equal to its capacity Q . This is formalised as,

$$\sum_{i,j} m_j a_{i,j,k} + \sum_i m_i f_{i,k} \leq Q \quad \forall k \quad (3)$$

Travel time constraints are applicable between any two locations, based on the distance between them, the speed v at which vehicles can travel, and the fixed service time Δ required at each customer.

$$t_{i,k} \geq \frac{d_{o,i}}{v} \text{ if } f_{i,k} = 1 \quad \text{and} \quad t_{i,k} \geq t_{j,k} + \Delta + \frac{d_{j,i}}{v} \text{ if } a_{j,i,k} = 1 \quad (4)$$

The vehicle capacity utilisation ratio for this trip is given by, $\frac{\sum_{i,j} m_j a_{i,j,k} + \sum_i m_i f_{i,k}}{Q}$. On each leg of the route, a minimum travel time proportional to the distance is enforced. The service for the first customer on the route can start at $(d_{o,i} f_{i,k})/v$ or later. A fixed service time of Δ units is assumed, which means the vehicle must stay at the customer location for this time. The service for the next customer can then start after a further $(d_{i,j} a_{i,j,k})/v$ time units, and so on.

4 Methodology

The proposed solution composed of three phases (i) Training a Graph Auto Encoder (Zhang et al., 2022) to get the node embeddings of the graph, and (ii) using these learnt embeddings along with other state features to train a DQN (Mnih et al., 2015) agent to assign warehouses to customers. The third phase incorporates a VRP agent to compute routes and assign vehicles.

4.1 Generating graph embeddings

We train a graph auto encoder (Zhang et al., 2022) using the Pytorch geometric library (Fey and Lenssen, 2019) in Python, to generate node embeddings for each customer. The GAE requires the input of a graph $G = (V_t, E_t)$. In our cases, the vertex set V_t is composed purely of the customer locations as features. The edges (and hence adjacency matrix) is constructed such that there is an edge between two customers if distance between them falls within nearest distance warehouse neighbourhood radius. The Encoder of GAE model takes input features such as the customer locations and adjacency matrix, and learns an embedding for each node of the graph in a 2-dimensional embedding space. The decoder, which is used to reconstruct the graph, is based on a Euclidean distance metric that calculates the distance between two embeddings. Specifically, we define the similarity between two embeddings e_1 and e_2 by,

$$\text{similarity} = 1 - \frac{\|e_1 - e_2\|_2}{\max\|e_1 - e_2\|_2}.$$

4.2 C2S Learning Agent (C2S-L) - Fulfillment node selection

C2S problem as defined in previous section can be modelled as a Markov Decision Process $(\mathcal{S}, \mathcal{A}, \mathcal{T}, \mathcal{R}, \gamma)$, where, \mathcal{S} denotes the current state of the system, \mathcal{A} represents action space (mapping customer c_i to a warehouse j), $\mathcal{T} : (\mathcal{S}, \mathcal{A}) \rightarrow \mathcal{S}$ represents transition probabilities, \mathcal{R} is the set of rewards, and γ is the discount factor for future rewards. In prior work (Pathakota et al., 2023), the task of C2S was only to allocate a fulfillment node (warehouse) to each customer, optimizing a multi-objective function consisting of various costs. They assumed that delivery of order happens instantaneously as soon as the decision was made by C2S, excluding the routing for vehicles and also ignored time window constraints as a result.

The graph embeddings produced by the GAE, are concatenated with other state features (Table 2 mentioned in Appendix) to result in an input vector of size 19 for each customer. The action space for each customer is of size $N + 1 = 5$, where N is the number of warehouses. The first N actions correspond to assignment to that particular warehouse ID, while the last action is a choice to defer the customer fulfillment to the next decision point (after T time units). Proceeding in a first-come-first-served (FCFS) order, the RL agent computes a decision for each customer. This list includes any customers carried over from previous time steps, as well as ones generated in the current time step. Once all the decisions are completed, the customers assigned to each warehouse are communicated to the VRP agent (Section 4.3) for delivery scheduling and routing.

4.2.1 Reward for C2S-L Agent

The step reward for the RL agent is composed of the following components:

- Transportation reward, composed of two components. First, we assign a negative reward D_i proportional to the straight-line distance from the warehouse to the location of customer c_i . The second term is a negative reward L_i proportional to the distance travelled by the vehicle in that particular trip, equally apportioned to all the customers being served in that trip. If the vehicle has a round-trip distance of Z for a trip that serves r customers, then $L_i \propto -Z/r$. D_i is in the range² of $[-2.12, 0]$, and L_i is the range of $[-1, 0]$.
- A fixed fulfillment reward $F_i = 1$ when customer c_i is assigned to a warehouse, and 0 if the customer is deferred to a future time step.
- A negative reward U_i proportional to the empty space on the vehicle when it starts on a trip, given equally to all the customers served in that trip. It also falls in the range $[-1, 0]$. The overall reward function is defined by,

$$\text{reward}(c_i) = a_1 (D_i + L_i) + F_i + a_2 U_i, \quad (5)$$

where a_1 and a_2 are user-defined constants. Apart from this, a fixed penalty of -10 is assigned if a customer is dropped completely (not served before the time window $\theta_{i,\max}$ elapsed). Note that the terms L_i and U_i depend on the route computed by the VRP agent. There is a special case for reward computation when the customer is deferred to a future time step. For this decision, the quantities

²In the 2D space, the farthest euclidean distance between a customer and a warehouse is $1.5\sqrt{2} \approx 2.12$

from (5) cannot be computed immediately. We therefore use a backward reward computation (in the Monte-Carlo style) from the time step when the customer is actually served. We define the reward as,

$$\text{reward}(c_i, \text{deferred}) = \gamma^h (a_1(D_i + L_i) + F_i + a_2U_i) \quad (6)$$

where h denotes the number of times service for deferred for c_i , and the remaining quantities correspond to when the customer was actually served. The calculated expected return is used as the reward in the TD-error calculation in the Bellman equation, which is used to train the model on samples that have the holding (deferred) action selected.

4.3 VRP learning Agent (VRP-L) - Routing and Scheduling

The problem of routing the vehicle to serve the customer is a sequential decision making problem and modelled as an MDP. The VRP-L agent is adapted from (Khadilkar, 2022), where the input to agent includes information corresponding to customer-vehicle pairs post C2S decisions. The agent in (Khadilkar, 2022) which is designed for single depot problem is applied to Multi-Depot problem in this study, by a parallel process of decisions at different depots as the customers allocated to particular depot must be fulfilled by a vehicle originating from that depot. We have incorporated official codebase for VRP-L (Khadilkar, 2022) in our study and scaled it for multi-depot and further details corresponding to it mentioned in appendix A.

4.3.1 Reward for VRP-L Agent

In this framework, a vehicle denoted as k caters to a set of P customers indexed by p from a particular warehouse along its route. Each segment of this route has a distance of d_p and necessitates t_p units of time between completing service at the preceding customer and initiating service at the current customer. The range of the neighborhood is determined by ρ , and τ serves as a time limit, equating to the median travel time between all pairs of customers within the dataset. Consequently, the reward associated with each decision is as follows:

$$\mathcal{R}_{k,p} = \frac{\rho - d_p}{d_{max}} + \frac{\tau - t_p}{t_{max}} + \gamma^{P-p} \mathcal{R}_{term}, \text{ where } \mathcal{R}_{term} = 2\rho - \frac{1}{P+1} \left(\sum_p d_p + D_{return} \right) \quad (7)$$

The reward equation is designed to encourage shorter legs in both distance and time. The terminal reward, denoted as \mathcal{R}_{term} as defined in equation (7), measures the average distance of individual legs within a vehicle's journey (including the last leg back to the depot) relative to the largest cluster diameter, which is represented as 2ρ . The objective of training the neural network is to minimize the mean squared error between its output and the actual realized reward $\mathcal{R}_{k,p}$, for each decision.

5 Baselines

Fulfillment Node Selection Heuristic (C2S-H) : We refer to this baseline as C2S Heuristic (C2S-H) as it essentially allocates each customer to the nearest warehouse immediately upon their generation. It's worth mentioning that our conversations with experts in the business domain have indicated that this approach closely aligns with the typical practice followed by a majority of retailers.

Vehicle Routing Problem Heuristic (VRP-H) : The VRP policy is employed to determine the most efficient route for a group of vehicles to deliver customer orders while adhering to constraints like vehicle capacity and customer time-windows. In our current scenario, we employ a straightforward heuristic that relies on the warehouse assignments provided by the C2S agent to fulfill the customer demand. The VRP Heuristic or (VRP-H) is designed to ensure that the vehicles visit and serve the customers within the specified time windows, while also meeting total time and vehicle carrying capacity constraints. While more advanced heuristics are available, we opt for a simple approach with the primary aim at satisfying constraints rather than achieving optimality. The procedure for the same is described below which can be carried out in a parallel fashion:

1. Sort the assigned customers at the warehouse according to their time window opening.
2. If no vehicle is at the depot, start a new one.
3. Choose the first feasible customer from the list, based on travel time, time window constraint, and demand quantity. Serve this customer and update time and remaining vehicle capacity.

Table 1: Agent versions with description: values in superscript indicate reference sections.

Agent	Description
<i>C2S-H + VRP-H</i>	Combination of the C2S-Heuristic and VRP-Heuristic ⁵ , serving as a comprehensive heuristic baseline
<i>C2S-L + VRP-H</i>	Utilizes the C2S Agent ^{4,2} along with the VRP-Heuristic ⁵
<i>C2S-H + VRP-L</i>	Incorporates the C2S-Heuristic ⁵ and the VRP-Agent defined in ^{4,3}
<i>C2S-L + VRP-L</i>	Signifies the use of both agents as learning-based for C2S and VRP.
<i>C2S-P + VRP-L</i>	We use a pre-trained model from C2S-L + VRP-H to set the weights for the C2S agent, and the VRP agent also adopts a learning-based approach. Our training strategy unfolds in two phases: first, we exclusively train the C2S Agent with VRP-H, and subsequently, we train the VRP Agent based on decisions made by the pre-trained C2S Agent without further training.

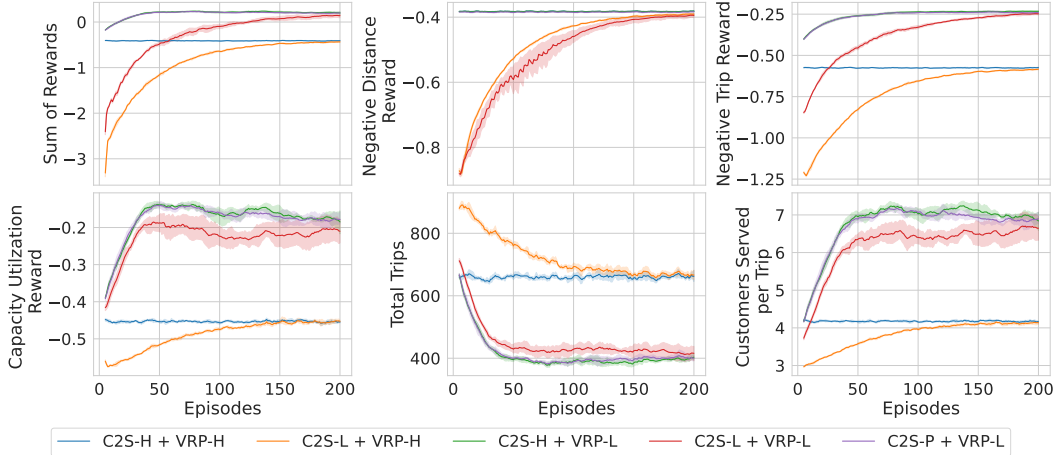

Figure 3: The figure has six plots, divided into two rows. The top row shows the Sum of Rewards, Negative Distance Reward, and Negative Trip Reward from left to right. The bottom row displays Capacity Utilization Reward, Vehicle Trips, and Served Customers per Trip from left to right. For the RL proposed agent, the shaded regions represent the standard deviation across 5 seeds.

4. Repeat the above step until there are no further feasible customers.
5. Return the vehicle to the warehouse and update its availability time.
6. Repeat steps 2-5 with additional vehicles until all customers are either (i) served, or (ii) computed to be infeasible for any vehicle. A penalty will be applied in the latter case.

We have trained five agent versions depending on the types of available algorithms, as per Table 1.

6 Experiments and Results

Training: We trained different agent versions and plotted the training curves to see how they perform across different metrics. The description of each agent is given in Table 1. Any versions involving a learning based agent are trained for 200 episodes using an ϵ -greedy approach. Please note that the customer locations are uniformly randomly generated in the 2D grid during training.

Figure 3 shows the average training curves for all the different agents, taken over 5 random seeds. For the learning based agents, the shaded regions represent the standard deviation across all random seeds. The top-left figure shows a simple sum of all the reward components. It can be seen that the *C2S-P + VRP-L* and *C2S-H + VRP-L* outperform the rest of the agents and converges pretty fast. Where *C2S-L + VRP-L* converges almost to the similar scale. The other plots provide greater insight into the agent’s performance. The top middle-figure plots the straight-line distance reward D_i and is constant for the agents having C2S-H and C2S-P (*C2S-H + VRP-H*, *C2S-H + VRP-L* and *C2S-P + VRP-L*) since for them the C2S agent is not trained. Since the heuristic always picks the nearest warehouse (in the case of C2S-P we make use *C2S-L + VRP-H* which almost learns to pick the customers like the heuristic)

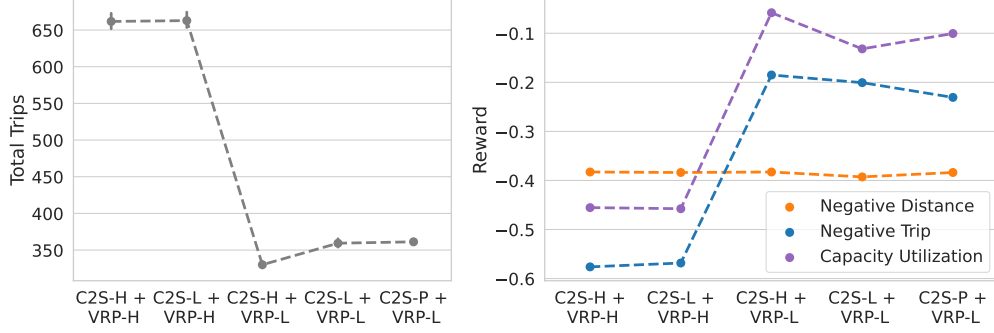

Figure 4: Testing values of metrics averaged over 20 episodes for the different agents. The left figure plots the average number of total trips for different agents, whereas the figure on the right plots the different rewards namely Negative Distance, Negative Trip and Capacity Utilization.

this plot shows that the RL agents learn similar warehouse assignment and minimize the distance. But having similar warehouse assignment does not guarantee better customer-vehicle mapping. In the top-right plot, the trip reward L_i depicts that having a learning based VRP agent does better grouping as the trips comprise of more efficient routes by minimizing the overall trip distance. The bottom-left figure depicts the capacity utilization U_i , here it is visibly seen that learning-based VRP agents due to their efficient routing are able to utilize the vehicle capacity better compared to VRP-H. The $C2S-H + VRP-L$ and $C2S-P + VRP-L$ have the best capacity utilization compared to others. The bottom-middle figure displays the total number trips taken by agent for serving all the customers. The learning-based VRP agents outperform the rule-based VRP agent by a margin with almost 40% lesser trips. All the RL agents initially take more number of trips during the exploration phase due to random warehouse assignments, but it gradually learns to serve the customers in fewer trips with improved and efficient routing. The final bottom-right figure illustrates the number of customers served per trip, here we can see that the agents $C2S-H + VRP-L$ and $C2S-P + VRP-L$ surpasses the rest of the approaches at the end of training.

Testing: We have also tested the performance of these agents by modifying the customer data distribution by introducing skewness in the probability distribution across the four quadrants. The trained agents are tested for 20 episodes across another set of 3 random seeds.

In Figure 4 we have compared the metrics of the baselines. The figure is split into two, the left figure shows the average number of total trips for each of the agents. We can see here that, the agent $C2S-H + VRP-L$ performs the best followed closely by the agents $C2S-L + VRP-L$ and $C2S-P + VRP-L$. In the figure on the right, we have plotted together the average of the crucial reward components namely negative distance, negative trip and capacity utilization. Here we can clearly see that the negative distance reward is almost constant for all the five agents. The difference lies in the rest of the two, the $C2S-H + VRP-H$ performs the worst with poor negative trip reward and capacity utilization. In the learning-based VRP agents the $C2S-H + VRP-L$ outperforms others with better trip reward and vehicle utilization. This is followed by the rest of the two where one component compensate the other. It can stated that having a learning-based VRP agent not only learns better routes but also indirectly benefit the learning-based C2S agent by scheduling efficient routes ultimately leading to better rewards being learnt during exploration. Please note that we do not have any shared information among the two agents we just have reward components derived from the vehicle routing decisions. Additional training and testing results are added in Appendix B

To sum it up, the two best performing agents $C2S-H + VRP-L$ and $C2S-P + VRP-L$ have very similar training and testing results with marginal difference. The only difference between the $C2S-P + VRP-L$ agent and $C2S-L + VRP-L$ is the way we have trained each of them where the pre-trained agent is trained in two phases (first C2S training followed by VRP training) compared to simultaneous training in the latter. We can infer that training both learning-based agents together reaches a local optima in performance as compared to training each one separately.

7 Conclusion and Future Work

We introduce and compare various methodologies for addressing the combined challenge of fulfillment node selection and vehicle routing within an integrated framework. As far as our knowledge extends, this marks the pioneering attempt to confront this commercially significant issue within the realm of e-commerce, utilizing a structured learning-based approach. Our two learning-based VRP agents consistently outperform the complete heuristic-based approach by a substantial margin. Furthermore, we demonstrate the robustness of these learned models across different customer data distributions, including skewed and random datasets. Given the complexity of this problem, characterized by dynamic demand and a large customer base, opting for a learning-based VRP agent proves to be the most effective strategy, in contrast to simplistic VRP heuristics. Looking ahead, our future research aims to delve deeper into this multi-agent setup, with a specific focus on comprehensive learning-based approaches. We are keen to explore the impact of introducing shared information (features), credit assignment for cooperative training, and the implementation of a central critic shared among the C2S and VRP agents, among other aspects.

References

- Barrie M. Baker and M.A. Ayechev. 2003. A genetic algorithm for the vehicle routing problem. *Computers & Operations Research* 30, 5 (2003), 787–800. [https://doi.org/10.1016/S0305-0548\(02\)00051-5](https://doi.org/10.1016/S0305-0548(02)00051-5)
- John E. Bell and Patrick R. McMullen. 2004. Ant colony optimization techniques for the vehicle routing problem. *Advanced Engineering Informatics* 18, 1 (2004), 41–48. <https://doi.org/10.1016/j.aei.2004.07.001>
- Alan Braithwaite and Edouard Samakh. 1998. The Cost-to-Serve Method. *International Journal of Logistics Management, The* 9 (01 1998), 69–84. <https://doi.org/10.1108/09574099810805753>
- Robin Cooper and Robert Kaplan. 1997. Cost & effect: using integrated cost systems to drive profitability and performance. (01 1997).
- Matthias Fey and Jan E. Lenssen. 2019. Fast Graph Representation Learning with PyTorch Geometric. In *ICLR Workshop on Representation Learning on Graphs and Manifolds*.
- Thomas Gaudelet, Ben Day, Arian R Jamasb, Jyothish Soman, Cristian Regep, Gertrude Liu, Jeremy BR Hayter, Richard Vickers, Charles Roberts, Jian Tang, et al. 2021. Utilizing graph machine learning within drug discovery and development. *Briefings in bioinformatics* 22, 6 (2021), bbab159.
- Abhinav Gupta, Supratim Ghosh, and Anulekha Dhara. 2022. Deep Reinforcement Learning Algorithm for Fast Solutions to Vehicle Routing Problem with Time-Windows. In *Joint International Conference on Data Science & Management of Data*. 236–240.
- Charles W Haley and Robert C Higgins. 1973. Inventory policy and trade credit financing. *Management science* 20, 4-part-i (1973), 464–471.
- Charles C Holt, Franco Modigliani, and Herbert A Simon. 1955. A linear decision rule for production and employment scheduling. *Management Science* 2, 1 (1955), 1–30.
- Brian Kallehauge. 2008a. Formulations and exact algorithms for the vehicle routing problem with time windows. *Computers & Operations Research* 35 (07 2008), 2307–2330. <https://doi.org/10.1016/j.cor.2006.11.006>
- Brian Kallehauge. 2008b. Formulations and Exact Algorithms for the Vehicle Routing Problem with Time Windows. *Comput. Oper. Res.* 35, 7 (jul 2008), 2307–2330. <https://doi.org/10.1016/j.cor.2006.11.006>
- Robert Kaplan and V.G. Narayanan. 2001. Measuring and managing customer profitability. 15 (09 2001).

- Harshad Khadilkar. 2022. Solving the capacitated vehicle routing problem with timing windows using rollouts and MAX-SAT. In *Indian Control Conference*.
- Elias Khalil, Hanjun Dai, Yuyu Zhang, Bistra Dilkina, and Le Song. 2017. Learning combinatorial optimization algorithms over graphs. *Advances in neural information processing systems* 30 (2017).
- Douglas M Lambert and Martha C Cooper. 2000. Issues in supply chain management. *Industrial marketing management* 29, 1 (2000), 65–83.
- Zeyi Liu, Yuan Wang, Xingxing Liang, Yang Ma, Yanghe Feng, Guangquan Cheng, and Zhong Liu. 2022. A graph neural networks-based deep Q-learning approach for job shop scheduling problems in traffic management. *Information Sciences* 607 (2022), 1211–1223. <https://doi.org/10.1016/j.ins.2022.06.017>
- Chryssi Malandraki and Mark Daskin. 1992a. Time Dependent Vehicle Routing Problems: Formulations, Properties and Heuristic Algorithms. *Transportation Science* 26 (08 1992), 185–200. <https://doi.org/10.1287/trsc.26.3.185>
- Chryssi Malandraki and Mark Daskin. 1992b. Time Dependent Vehicle Routing Problems: Formulations, Properties and Heuristic Algorithms. *Transportation Science* 26 (08 1992), 185–200. <https://doi.org/10.1287/trsc.26.3.185>
- Volodymyr Mnih, Koray Kavukcuoglu, David Silver, Andrei A Rusu, Joel Veness, Marc G Bellemare, Alex Graves, Martin Riedmiller, Andreas K Fidjeland, Georg Ostrovski, et al. 2015. Human-level control through deep reinforcement learning. *nature* 518, 7540 (2015), 529–533.
- Mohammadreza Nazari, Afshin Oroojlooy, Lawrence Snyder, and Martin Takác. 2018. Reinforcement learning for solving the vehicle routing problem. *Advances in neural information processing systems* 31 (2018).
- Pranavi Pathakota, Hardik Meisheri, Kunwar Zaid, Anulekha Dhara, Shaun D’Souza, Dheeraj Shah, and Harshad Khadilkar. 2023. Learning to Minimize Cost to Serve for Multi-Node Multi-Product Order Fulfilment in Electronic Commerce. In *International Conference on Data Science & Management of Data*.
- Nazneen N Sultana, Vinita Baniwal, Ansuma Basumatary, Piyush Mittal, Supratim Ghosh, and Harshad Khadilkar. 2021. Fast Approximate Solutions using Reinforcement Learning for Dynamic Capacitated Vehicle Routing with Time Windows. *arXiv preprint arXiv:2102.12088* (2021).
- Xu Wang, Zimu Zhou, Fu Xiao, Kai Xing, Zheng Yang, Yunhao Liu, and Chunyi Peng. 2018. Spatio-temporal analysis and prediction of cellular traffic in metropolis. *IEEE Transactions on Mobile Computing* 18, 9 (2018), 2190–2202.
- Richard Wilding. 2020. Understanding Supply Chain cost drivers. In <https://www.richardwilding.info/supply-chain-finance-and-cost-to-serve.html>.
- Shiwen Wu, Fei Sun, Wentao Zhang, Xu Xie, and Bin Cui. 2022. Graph neural networks in recommender systems: a survey. *Comput. Surveys* 55, 5 (2022), 1–37.
- Zhang Zhang, Ruyi Tao, Yongzai Tao, and Jiang Zhang. 2022. Graph Auto-Encoders for Network Completion. *arXiv preprint arXiv:2204.11852* (2022).

Appendix

This section includes the supplementary material.

A Neural network architecture and training

GAE: The architecture for GAE consists of two graph convolutional layers (2-hop) with the embedding output dimension of 2, with ReLU activation function for hidden layers. The adjacency matrix is constructed by creating positive and negative samples, where positive samples are all instances with edges between two nodes (a relative minority) and negative samples are randomly selected pairs of nodes without edges from the graph (equal in number to the positive samples). The training of the GAE is done iteratively from a buffer of 1000 graphs which are previously generated by running simple heuristic policies for both C2S and VRP functions.

C2S-L Agent: The RL agent is a Deep Q-Learning Network model for customer-warehouse mapping with 19 inputs mentioned in Table 2 and 5 outputs, as described earlier. The DQN model has a neural network architecture with 4 fully connected layers. The dimensions of the layers are [19, 76, 38, 5], where the first and last layers are the input and output layers respectively. The hidden layers have a \tanh activation function, while the output layer has a linear activation function. The model is trained using the PyTorch library in Python 3.8, with an Adam optimizer, a discount factor of 0.9, a batch size of 512, and a mean squared loss function. The experience replay buffer has a capacity of 1,00,000 samples, which are randomly drawn to train the C2S agent.

VRP-L Agent: The input is a vector of size 17, as specified in Table 3. This is followed by a fully connected neural network with layers of size (128, 64, 32, 8) and an output layer of size 1 (scalar value). The hidden layers have \tanh activation. A memory buffer of maximum 1,00,000 samples is maintained, with training happening after every 4 times every 100 timesteps (basically after completion of each depot routing) with a batch of size 512 samples. The learning rate is 0.001. Exploration is implemented using an ϵ -greedy policy with ϵ decayed from 1 to 0 with a factor of 0.999 after each episode. Exploration steps are taken uniformly randomly, while exploitation steps are chosen using a softmax function over the values attached to vehicle-customer pairs.

B Additional Results

In fig. B and 6 we can see that *C2S-H* always assigns the customers to their nearest warehouse, these must be fulfilled by the vehicles originating from that depot as can be seen in the left-top most figure of *C2S-H + VRP-H* and *C2S-H + VRP-L*. This behaviour of always assigning nearest warehouse is not observed in any *C2S-L agent* baseline, and results show there is an aggregation of the customers of neighbourhood areas. From the scatter we can clearly see this in *C2S-L + VRP-H*, *C2S-L + VRP-L* and *C2S-P + VRP-L*. In some cases, always assigning nearest warehouse may not result in optimal solution and aggregating the customer orders to second nearest warehouse may result in overall less trip distance, utilization of lesser number of vehicles increasing capacity utilization. These observations are true for both the types of customer data distribution (Training - Uniform Data and Testing - Skewed Data).

Total capacity utilization per vehicle is shown in the figure 7 Training (Uniform Data), and it can be seen that in the case of agents *C2S-P + VRP-L* and *C2S-H + VRP-L*, total utilization of a vehicle is almost at 80% followed by *C2S-L + VRP-L* agent. This shows that learning based approach for VRP resulted in better routing of customers, which resulted in utilization at greater capacity. The other two agents *C2S-H + VRP-H* and *C2S-L + VRP-H* resulted in the usage of only 40% of vehicle capacity, which clearly indicates that incorporating *VRP-L* resulted in the increase of vehicle capacity

Feature	Description	Size
Embeddings	Output of GAE	2
Distance	Distance $d_{j,i}$ from each warehouse	$N = 4$
Local Availability	Quantity P_j of current product available at each warehouse	$N = 4$
Demand	Customer demand p_i for current product	1
Time Window	Interval $[\theta_{i,\min}, \theta_{i,\max}]$ during which order to be fulfilled	2
Clock	Current timestep in environment	1
Holding Interval	Amount of time the order is put on hold	1
Warehouse Indicator	Vehicle availability at depots	$N = 4$

Table 2: Features in state representation for each customer c_i , used by C2S agent as input.

Table 3: VRP Agent inputs for evaluating the value of each vehicle-customer pair, with loc as current location, c as proposed customer, and v as the proposed vehicle. All features are normalised as explained in text.

Input	Explanation
d	Distance from loc to c
$b_{d,short}$	Is d smaller than neighbourhood radius ρ
t	Time gap from now to start of service at c
$b_{t,short}$	Is time gap within time threshold τ
ngb	Are loc and c part of the same cluster
non_d	If $ngb = 1$, distance from c to nearest non-member
c_left	If $ngb = 0$, are any in-cluster customers left unserved
$drop_{far}$	If $c_left = 1$, are the dropped customers farther from depot than loc
$drop_{cls}$	If $c_left = 1$, are dropped customers within a distance of ρ from loc
$drop_{long}$	If $c_left = 1$, is the distance from dropped customers to nearest non-member more than distance from loc to dropped customers
$served$	How many customers of c cluster has v served so far
cls_{dem}	Could v serve all cluster members of c based on demand
$hops$	How many cluster members of c can be served before c
cls_{tim}	Is every cluster member feasible following c
$urgt$	How close to time window closure of c is v arriving
$dfrac$	Ratio of time being consumed for serving c to the fraction of v 's capacity being consumed
$remote$	How remote is the neighbourhood of c

utilization by almost double. The similar behaviour is observed in Testing(Skewed Data), where the capacity utilization per vehicle at each varies by large margin in case of agents with learning agents compared with the heuristic approaches.

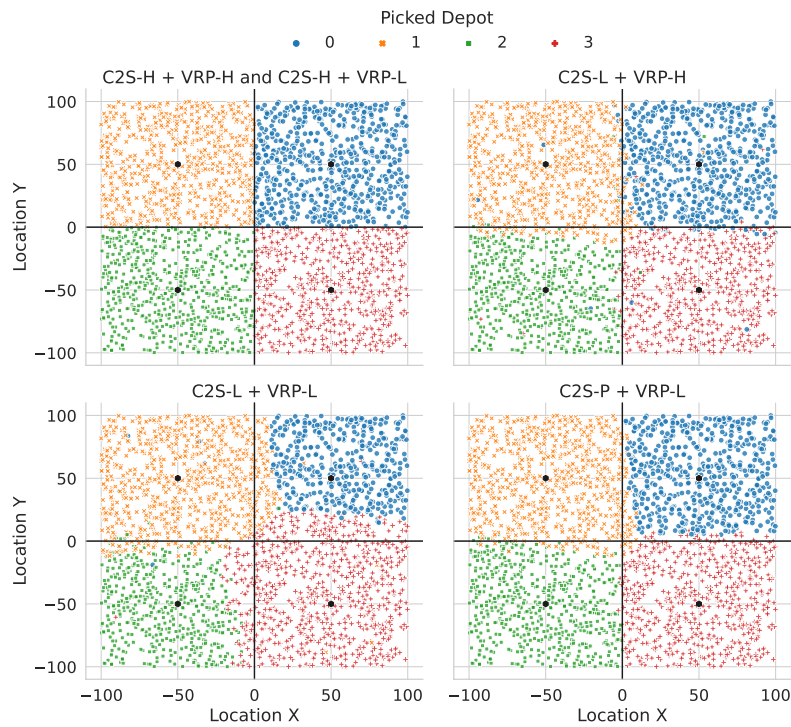

Figure 5: Scatter plot illustrating the training data with various customer markers, each assigned to a specific depot by the C2S Agent. A black hexagon marks the warehouse location in each quadrant, and bold black lines separate the depot areas for clarity. The figure is divided into four sub-figures, each corresponding to a different baseline mentioned in the subplot title. It's worth noting that this figure represents uniform customer data distribution, with customers equally distributed in all quadrants.

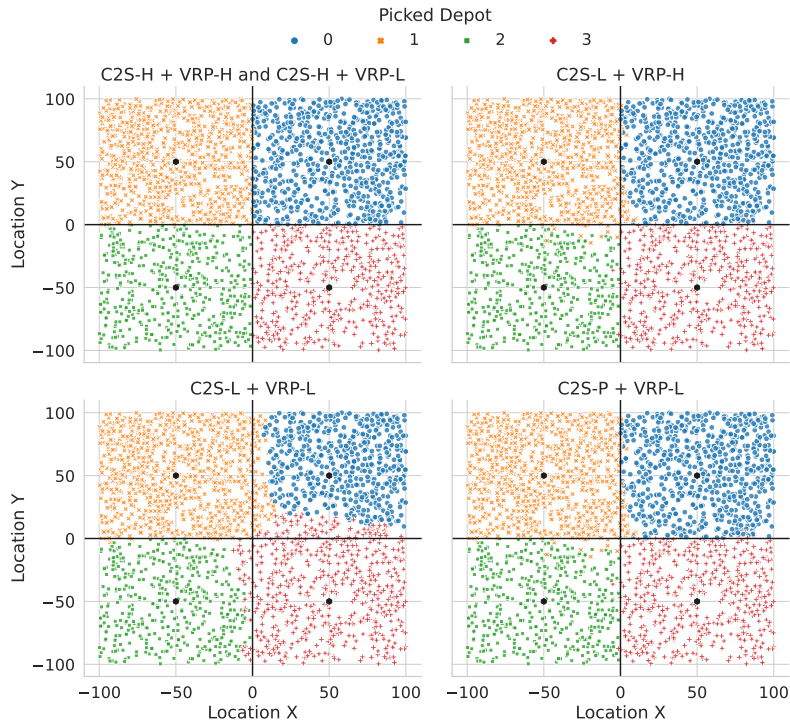

Figure 6: This scatter plot tests various baselines across the entire customer space. Customers are color-coded and marked according to their assigned depot by the C2S Agent. A black hexagon represents the warehouse in each quadrant, and bold black lines separate the depot quadrants for clarity. The figure is divided into four sub-figures, each labeled with its baseline. Note that the customer data distribution is skewed, with more customers concentrated in the upper two quadrants compared to the lower two.

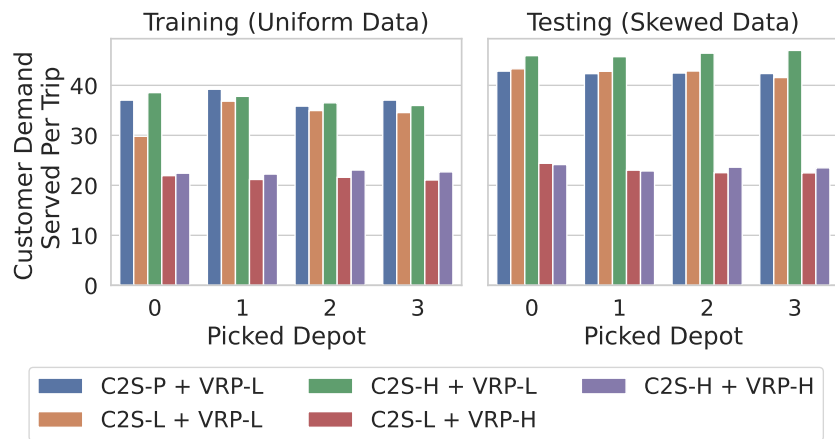

Figure 7: Barplots for showing the average customer demand served per trip for the different agents across depots for both the customer data distributions.