

# Language Evolution with Deep Learning

Chapter to appear in the *Oxford Handbook of Approaches to Language Evolution*

**Mathieu Rita**<sup>\*1</sup>, **Paul Michel**<sup>2</sup>, **Rahma Chaabouni**<sup>2</sup>, **Olivier Pietquin**<sup>5</sup>,  
**Emmanuel Dupoux**<sup>3,4</sup>, **Florian Strub**<sup>5</sup>

<sup>1</sup>INRIA, Paris

<sup>2</sup>Google DeepMind

<sup>3</sup>Meta AI Research

<sup>4</sup>EHESS,ENS-PSL,CNRS,INRIA

<sup>5</sup>Cohere

## Abstract

Computational modeling plays an essential role in the study of language emergence. It aims to simulate the conditions and learning processes that could trigger the emergence of a structured language within a simulated controlled environment. Several methods have been used to investigate the origin of our language, including agent-based systems, Bayesian agents, genetic algorithms, and rule-based systems. This chapter explores another class of computational models that have recently revolutionized the field of machine learning: deep learning models. The chapter introduces the basic concepts of deep and reinforcement learning methods and summarizes their helpfulness for simulating language emergence. It also discusses the key findings, limitations, and recent attempts to build realistic simulations. This chapter targets linguists and cognitive scientists seeking an introduction to deep learning as a tool to investigate language evolution.

Supplementary technical materials can be found at

[https://github.com/MathieuRita/LangageEvolution\\_with\\_DeepLearning](https://github.com/MathieuRita/LangageEvolution_with_DeepLearning)

## 1 Introduction

Social animals have been found to use some means of communication to coordinate in various contexts: foraging for food, avoiding predators, mating, etc. (Hauser, 1996). Among animals, however, humans seem to be unique in having developed a communication system, natural language, that transcends these basic needs and can represent an infinite variety of new situations (Hauser et al., 2002) to the extent that language itself becomes the basis for a new form of evolution: cultural evolution. Understanding the emergence of this unique human ability has always been a vexing scientific problem due to the lack of access to the communication systems of intermediate steps of hominid evolution (Harnad et al., 1976; Bickerton, 2007). In the absence of data, a tempting idea has been to reproduce experimentally the process of language emergence in either humans or computational models (Steels, 1997; Myers-Scotton, 2002; Kirby, 2002).

Experimental paradigms with humans (Kirby et al., 2008; Raviv et al., 2019; Motamedi et al., 2019) have produced significant insights into language evolution. Still, their scope is limited due to the inability to replicate key aspects of language evolution, such as communication within and across large populations and the study of long evolutionary timescales. Computer modeling can help overcome these limitations and has played a prominent role in studying language evolution for a long time (Lieberman and Crelin, 1971). In particular, agent-based modeling has been used from

---

\*Corresponding Author: mathieu.rita@inria.fr

the early days of the language evolution research “renaissance” (Hurford, 1989; Steels, 1995) and is still a very active and influential field (Reali and Griffiths, 2009; 2010; Smith et al., 2003; Vogt, 2009; Gong et al., 2014; Ke et al., 2008; Brace et al., 2015; Cuskley et al., 2017; Kirby et al., 2015).

Meanwhile, in the last decade, the field of machine learning has rapidly developed with the advent of deep learning. Deep neural networks have achieved human-level performance in various domains, including image recognition (He et al., 2016; Chen et al., 2020), natural language processing (Devlin et al., 2018; Brown et al., 2020), automatic translation (Bahdanau et al., 2014; Vaswani et al., 2017), and reinforcement learning (Silver et al., 2016).

This chapter aims to introduce the technical and conceptual background required for using deep learning to simulate language evolution, that is, to simulate both the emergence of communication in evolutionary timescales and patterns of language change in historical timescales (Kottur et al., 2017; Lazaridou et al., 2018; Lazaridou and Baroni, 2020)

First, we present how to implement a communication game (Sec. 2), including formalizing it as a machine learning problem (Sec. 2.1), designing neural network agents (Sec. 2.2) and making agents learn to solve the game (Sec. 2.3). Second, we examine the Visual Discrimination Game (Lewis, 1969) as a case study (Sec. 3), which has been widely explored in neural emergent communication research. Finally, we provide an overview of recent emergent communication simulations with neural networks, highlighting the successes, limitations, and future challenges (Sec. 4).

## 2 Designing communication games with Deep Learning

Communication games (Lewis, 1969; Steels, 1995; Baronchelli et al., 2010) are a framework used to investigate how perceptual, interactive, or environmental pressures shape the emergence of structured communication protocols (Kirby et al., 2008; Cuskley et al., 2017; Raviv et al., 2019). This framework has primarily been studied over the past 50 years and is still one of the leading simulation frameworks in language evolution. See Chapter *Communication games: Modelling language evolution through dyadic interaction* for more details. This section presents how to simulate communication games using Deep Learning. First, we frame the communication game as a multi-agent problem, where each agent is represented by a deep neural network (Sec. 2.1). Second, we define communicative agents (Sec. 2.2). Third, we use machine learning optimization to train agents to solve the communication game (Sec. 2.3).

### 2.1 Framing communication games as a machine learning problem

#### 2.1.1 Machine learning is well suited for simulating communication games

Mitchell (1997) defines machine learning as follows:

“A computer program  $f$  is said to learn from an experience  $E$  with respect to some class of tasks  $T$  and performance measure  $P$ , if its performance at tasks in  $T$ , as measured by  $P$ , improves with experience  $E$ .”

Machine learning is well suited to frame communication games: participants develop a language through trial and error during a communication game. They iteratively adapt their language production and understanding to achieve a given task for which at least one agent lacks information (Tadelis, 2013). While game theoretic approaches analyze stable communication protocols (Crawford and Sobel, 1982; Skyrms, 2010), studying the dynamic learning process is a more challenging and richer problem. Borrowing Mitchell (1997) notations, this dynamic process can be framed as a machine learning problem where participants are computer programs  $f$  that perform the communication game  $T$ . The game’s success is measured by  $P$  after each episode  $E$  of the game, and participants update their communication protocol based on the outcome. After enough iterations, the participants may *converge*, i.e., stabilize on a successful communication protocol, allowing them to solve the game. This iterative learning process is illustrated in Figure 1 and is the fundamental idea of machine learning.

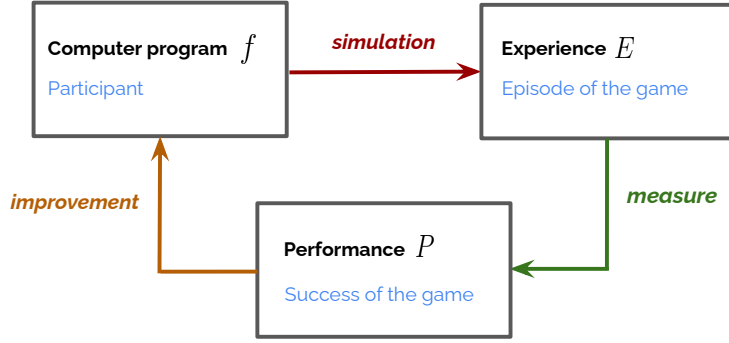

Figure 1: Iterative learning process in a machine learning problem. **Step 1 (simulation)**: The computer program  $f$  performs an experience  $E$  of the task  $T$ . **Step 2 (measure)**: The task’s success is measured through a performance measure  $P$ . **Step 3 (improvement)**: Based on its performance, the computer program  $f$  update to improve its future performance, i.e. learns. Communication games can be framed as a machine learning problem by modeling agents as computer programs. The experience  $E$  corresponds to an episode of the game, while a performance measure  $P$  measures the game’s success.

### 2.1.2 Formalizing communication games as a machine learning problem

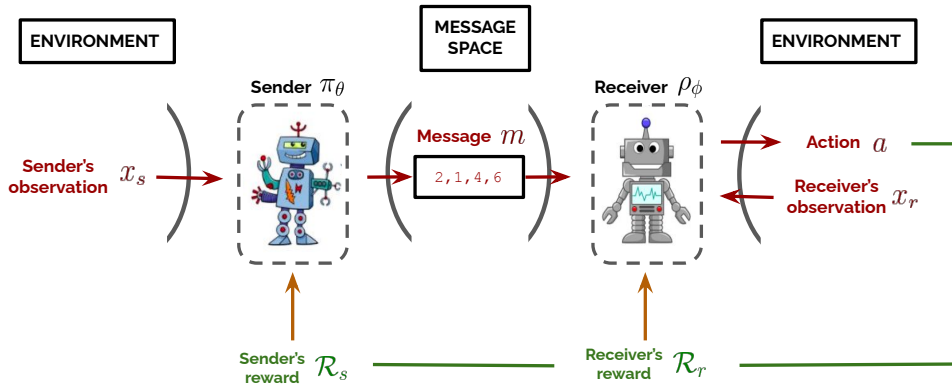

Figure 2: Scheme of a two-player communication game. **Step 1 (simulation)**: Agents play a round of the game: (1) both agents get observations from the environment, (2) The sender sends a message to the receiver, (3) The receiver uses the message and its observation to perform an action in the environment. **Step 2 (measure)**: One reward signal per agent measures the game’s success. **Step 3 (improvement)**: Agents receive the reward signals and update their behavior toward better solving the game.

For simplicity, we focus in this chapter on two-player communication games where one agent, the “sender” sends messages to a second agent, the “receiver” that parses them and takes action to solve the task in an environment<sup>1</sup>. Formally, the “sender” and “receiver” are parametric models respectively denoted by  $\pi_\theta$  and  $\rho_\phi$  with parameters  $\theta$  and  $\phi$ . Both parametric models will further be designed as deep neural networks. As illustrated in Figure 2, a round of the game proceeds as follows:

- The sender  $\pi_\theta$  and receiver  $\rho_\phi$  get observations from their environment denoted by  $x_s$  and  $x_r$ .
- The sender  $\pi_\theta$  sends a message  $m$  to the receiver  $\rho_\phi$  where  $m$  is a sequence of symbols taken from a fixed vocabulary  $\mathcal{V}$ .

<sup>1</sup>This setting is referred to as dyadic unidirectional communication games in the literature (Shannon, 1948; Harsanyi, 1967; Cho and Kreps, 1987; Lewis, 1969).

- The receiver  $\rho_\phi$  uses the message  $m$  and its observation  $x_r$  to perform an action  $a$  toward achieving the task.

The task’s success is then measured by two reward signals  $\mathcal{R}_s$  and  $\mathcal{R}_r$  which are given to the sender  $\pi_\theta$  and the receiver  $\rho_\phi$  respectively to improve their protocols. Throughout the game, both agents must agree on a common language to solve the game. Importantly, the emergent language is not defined by explicit language rules but implicitly encoded by the sender’s parameters  $\theta$ .

**Remark:** This chapter presents a simplified formalism of communication games. Rigorously, communication games should be framed as a special case of Markov Games that provide a broader formal framework for reasoning about multi-agent problems. For further information, refer to [Littman \(1994\)](#).

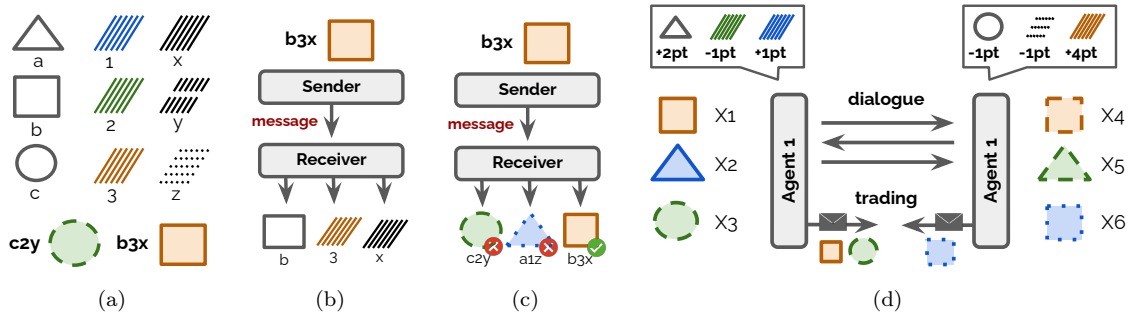

Figure 3: Examples of Lewis and negotiation games. (a) Example of Lewis game object’s attributes decomposition (shape, color, style). (b) In the Lewis reconstruction game, the sender observes an object composed of several independent attributes and describes it to the receiver. The receiver must then predict the initial object attributes. (c) In the Lewis discrimination game, the receiver must retrieve the object within a set of distractors. Such a setting does not require manually defining independent attributes, allowing the use of ambiguous real data inputs such as images. (a-c) Such Lewis games usually aim to explore the disentanglement skills of the sender toward producing a compositional language under different scenarios or learning pressures. (d) In negotiation games, agents value objects or attributes differently and get a set of initial objects. They then start dialoguing before executing a final trade. Such tasks involve diverse language interactions such as multi-turn communication, non-fully cooperative games, repeated games, or action binding.

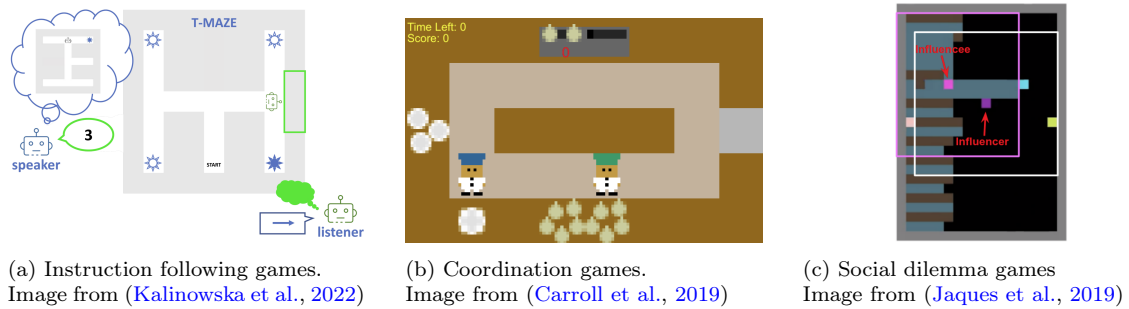

Figure 4: Attempts to go beyond Lewis and negotiation games by embodying agents into a 2D world. (a) In the following instruction tasks, the sender is aware of the extensive state of the world and must instruct the receiver on how to reach a predefined goal. Importantly, the receiver only has a partial view of its environment. Such tasks aim to explore how basic embodiment properties may shape communication. (b) In coordination games, the agent needs to communicate to execute joint tasks or improve coordination and success through communication. Such tasks ground language to actions. (c) In social dilemma games, agents are surrounded by multiple agents and must behave accordingly to survive. Such tasks explore multi-channel communication or behavioral communication through actions.

In a communication game, the deep neural agents aim to build communication and action policies. This is realized by maximizing their reward. The following is therefore needed:

1. Design the communicative agents as neural networks (Sec. 2.2)
2. Train agents to build a shared communication protocol (Sec. 2.3)

Figures 3 and 4 represent communication games commonly studied in language emergence simulations with deep learning. The former presents simple Lewis and negotiation games, while the latter showcases efforts to build more realistic scenarios.

**Remark:** At the time of writing, many Python libraries, like PyTorch (Paszke et al., 2017) and Jax (Bradbury et al., 2018), are used for easy implementation and optimization of neural networks and are particularly helpful for beginners due to the abundance of online examples.

## 2.2 Designing communicating agents with neural networks

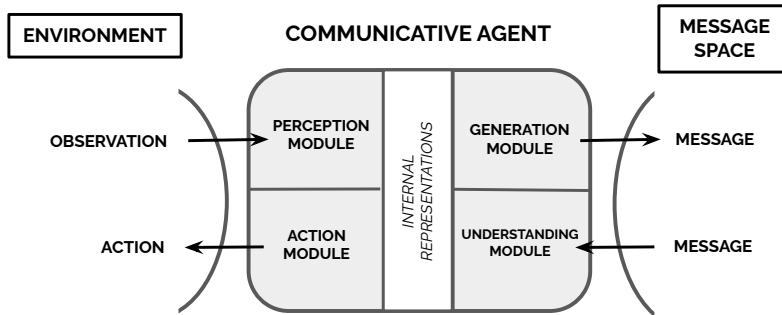

Figure 5: General view of a communicative agent. A communicative agent is composed of four functional modules: a **perception module** that maps an observation to an *internal representation*; a **generation module** that maps an *internal representations* to a message; an **understanding module** that maps a message to an *internal representation*; an **action module** that maps *internal representations* to an action.

To model communicative agents, we first break them into functional modules that enable interaction with the environment and other agents (Sec. 2.2.1). Then, define neural networks and explain how they can be used to parameterize these functional modules (Sec. 2.2.3). Finally, we introduce neural senders and receivers as specific types of neural communicative agents (Sec. 2.2.3).

### 2.2.1 Designing a communicative agent as functional modules

As depicted in Figure 5, a communicative agent should be able to interact with:

- *Its environment* by either passively observing it or actively taking actions that influence it ;
- *Another agent* using a message space by passively receiving or actively sending messages.

Therefore, four functional modules are typically needed to model agents: perception, generation, understanding, and action. (1) The perception module maps an environment’s view to an *internal representation*, (2) the generation module generates a message based on internal representations, (3) the understanding module takes a message and builds an *internal message representation*, (4) the action module maps an *internal representation* to an action in the environment.

Neural networks are suited for modeling and combining these modules.

## 2.2.2 Short introduction to neural networks

A neural network  $f_\theta$  is a parametric model approximating a function or probability distribution based on data. It maps vector inputs to outputs through a succession of linear and non-linear operations. Its learnable parameters  $\theta$ , called *the weights*, are used to perform the linear operations. The fundamental building block of a neural network is made of two operations:

- A **linear transformation** applying the matrix of weights  $\theta^i$  to the incoming input:
- A **non-linear transformation**  $\sigma$ , called the *activation function* (typically sigmoid function, hyperbolic tangent (LeCun et al., 1998) or ReLU (Nair and Hinton, 2010)):

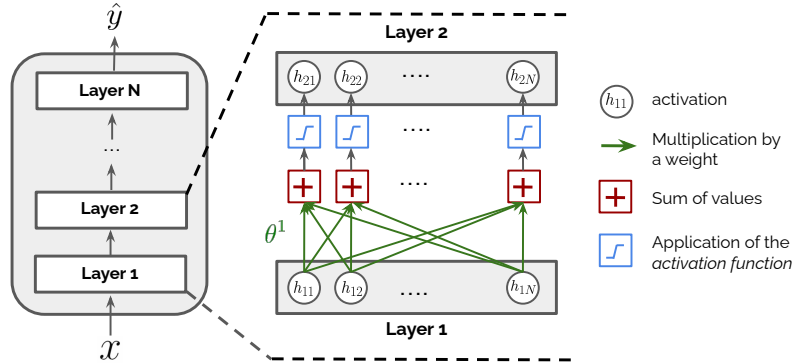

Figure 6: Scheme of a neural network and the operations between two layers. A neural network is a function that takes an input  $x = (x_1, \dots, x_n)$  and maps it to an output  $\hat{y}$ . It comprises several *layers* of *activations*. Each layer results from the application of two operations on the activations of the previous layers: (1) a linear transformation (multiplication by weights and sum), (2) a non-linear transformation (application of a non-linear function). A neural network is parameterized by all the weights acting between each layer.

As displayed in Figure 6, these operations are stacked at each *layer*, transforming the input  $x$  to a prediction  $\hat{y}$  through multiple linear and non-linear transformations.

**Remark:** Neural networks have a crucial property: all operations are differentiable. This allows for using gradient-based methods to learn the weights (see Section 2.3).

When training a neural network, the goal is to find the optimal weights  $\theta$  such that the neural network  $f_\theta$  accurately maps inputs to their corresponding outputs. Neural networks with enough weights can represent complex functions due to their high expressive power, approximating any continuous function with any level of precision (Hornik et al., 1989). However, computation or data limitations can hinder this process. Deep learning investigates how to adapt networks' architecture or weight matrix shape to overcome these limitations. Figure 7 presents the main network architectures and the data they are suitable for.

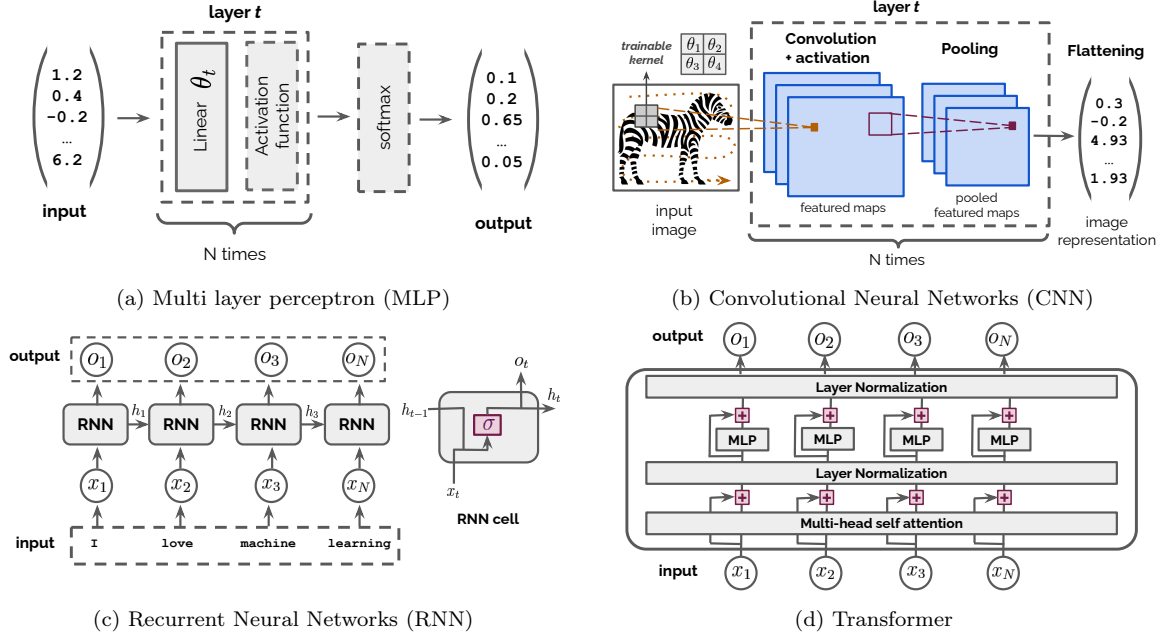

Figure 7: Classic neural network modules. Other architectures and/or variants such as Graph Neural Networks (Kipf and Welling, 2016) for graphs are not presented here.

(a) **Multi-layer perceptron (MLP)** (Rosenblatt, 1958) is commonly used to process scalar and heterogeneous input data. It consists of stacked layers, each composed of a linear transformation and a non-linear activation function. A softmax transformation can transform the final activation into a probability distribution.

(b) **Convolutional Neural Network (CNN)** (LeCun et al., 1988) are originally inspired by the visual cortex of animals (Fukushima, 1980), and are primarily used for visual data. The CNN's core block consists of three operations: a convolution, a non-linear activation function, and an optional downsampling function, aka pooling. The convolution uses a set of filters to scan the input image and detect specific features to build so-called feature maps. The activation function is applied to the feature maps, and then pooling is performed (e.g., taking maximum value over a window of the feature maps). This process is repeated several times, with each subsequent block learning more complex and abstract features. The final layer's output is flattened to provide an abstract input representation. Through the succession of convolutions, the neural network builds a hierarchy of features that capture specific features of the input, e.g., edges and colors.

(c) **Recurrent Neural Network (RNN)** (Elman, 1990; Mikolov et al., 2010; Sutskever et al., 2011) is an architecture designed to process input sequences one element at a time while maintaining an internal state that retains information about the past sequence elements. The memory of the RNN is called a state and denoted by  $h_t$ . It is updated every time the RNN processes an element, allowing it to use information from the past memory  $h_{t-1}$ . The RNN generates an output representation  $o_t$  as it processes each new element  $x_t$  of the ongoing sentence, and the final output  $o_N$  is often used to represent the entire sequence. However, Vanilla RNNs suffer from training instability when working with long sequences. Alternative architectures with more advanced in-cell operations like LSTMs (Hochreiter and Schmidhuber, 1997) or GRUs (Chung et al., 2014), and regularization methods like layer normalization (Ba et al., 2016) or gradient clipping (Pascanu et al., 2013) mitigate this issue.

(d) **Transformer** (Vaswani et al., 2017) is a more recent architecture that processes sequences in parallel rather than sequentially using attention mechanisms. These mechanisms allow selectively focus on different parts of the input sequence when processing it by differently weighting each input element based on its relevance at a given processing step. See Vaswani et al. (2017) for details on attention. Transformers are generally much faster and more efficient than RNNs. Although less intuitive than RNNs, they are replacing recurrent architectures due to their better performances and scalability advantages. Recent dialogue agent successes are based on the Transformer architecture (Brown et al., 2020; Hoffmann et al., 2022a).

### 2.2.3 Neural functional modules

Several network architectures can be considered when designing agents modules defined in Sec 2.2.1. This section presents some common choices for each module.

**Perception module** The perception module maps an observation of the environment to an *internal representation*. The choice of architecture depends on the input observation, which differs across games. For example, a *Convolutional Neural Network* (LeCun et al., 1988) is suitable for generating image representations from visual input data, as illustrated in Figure 7.

**Generation module** The generation module maps an internal representation, i.e., a vector of a given dimension, into a message. Recurrent neural networks (RNN) (Elman, 1990; Mikolov et al., 2010) and Transformers (Vaswani et al., 2017) are well suited for sequences and are hence used in standard emergent communication settings (Lazaridou et al., 2018; Chaabouni et al., 2019; Kottur et al., 2017; Li and Bowling, 2019; Chaabouni et al., 2022; Rita et al., 2022a). Communication is mainly based on discrete messages, even if some works consider continuous communication protocol (Tieleman et al., 2019).

**Remark:** To shape the message space, a *vocabulary* of symbols and a *maximum length* must be introduced. It’s also possible to add an end-of-sentence token *EoS* to indicate the end of the message. When making these design choices, task complexity should be considered; a larger vocabulary and message length allow for communicating more information/concepts, while a smaller vocabulary and message length require better information compression and, hence, a more structured communication protocol.

**Understanding module** The understanding module maps a message to an internal representation. Since messages are discrete sequences, RNNs, and Transformers are well-suited for this module.

**Action module** The action module maps an internal representation of an action in the environment. Since the internal representations are scalars and actions a finite set of possibilities, a well-suited architecture is the Multi-Layer Perceptron followed by a softmax that draws a probability distribution over the potential actions.

**Remark:** Deep learning techniques allow training a system composed of multiple differentiable modules end-to-end. The agent is seen as a single block that provides a prediction given input and output data instead of past methods that glue independently trained/designed blocks together. In communication games, the sender and receiver are both fully-differentiable individually. However, the message generation between them does not necessitate *on purpose* to separate the training of the agents. Nonetheless, the message generation can still be made differentiable as described in Section 2.3.2.

**Good practice:** Exploring various neural architectures is a common reflex when starting with deep learning. However, its impact is limited in practice compared to other experimental choices such as task definition, optimization, data, and training objective. Basic neural architectures are recommended to avoid compounding factors when comparing methods.

### 2.2.4 Modeling neural network communicative agents in communication games

Section 2.2 presents the components of a general communicative agent, though not all modules may be used during a game. Figure 8 illustrates sender and receiver modeling in a unidirectional game. This modeling is used in the use case we derive in Section 3, namely the Visual Discrimination Game.



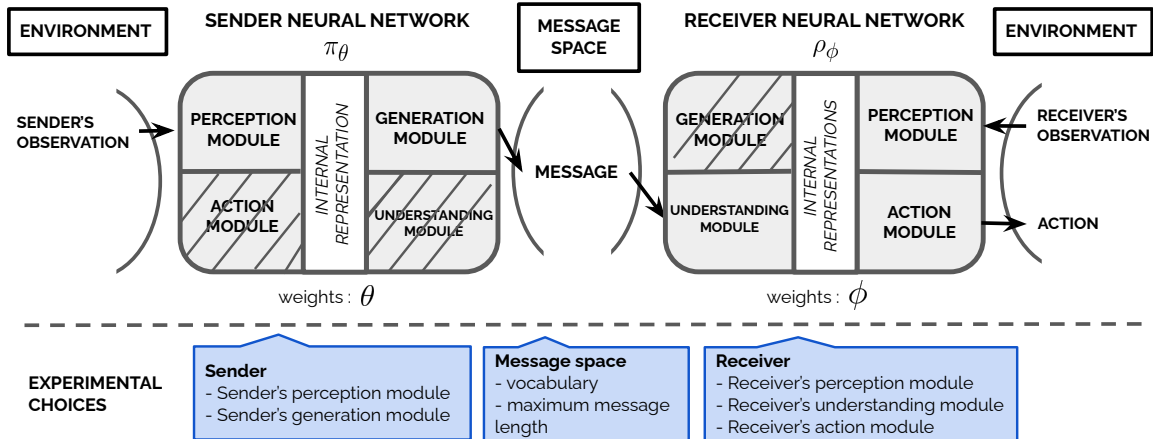

Figure 8: Summary of neural communicative agents modeling in a unidirectional communication game. The sender only uses a perception module to process observations and a generation module to create messages. The receiver uses a perception module to process observations, an understanding module to process messages, and an action module to interact with the environment. A vocabulary and maximum message length are defined for the sender’s generation. All the experimental choices are framed in blue.

## 2.3 Optimizing the agents to solve the game

In Deep Learning, the goal is to train neural networks to solve a task, i.e., find the optimal weights that maximize their performance. This section covers optimization techniques for training neural networks and their application to communication games.

### 2.3.1 Optimizing a machine learning problem

**Data and learning techniques** To train neural networks, suitable learning techniques must be chosen depending on the task and the availability of training *data*, which consists of input-output pairs  $(x, y)$ . Two standard techniques used to solve communication games are:

- **Supervised Learning (SL):** The neural network is given a training set  $\mathcal{D}_{train} = (x_n, y_n)_{n=1}^N$  of  $N$  input-output pairs  $(x_n, y_n)$ , and its objective is to learn how to map inputs to their corresponding outputs. An example of a supervised language task is the translation: the network learns to map one language to another by training on pairs  $x_n$  and  $y_n$ , where each pair consists of aligned source and target sentences. Supervised learning finds the weights that enable the network to generalize this mapping to new, unseen examples drawn from the same distribution as the training data, e.g., trying to translate beyond the initial corpus. In communication games, Supervised learning tasks often involve classification (e.g., object selection, attribute reconstruction, translation) and regression (e.g., drawing, pixel reconstruction).
- **Reinforcement learning (RL):** In RL, a neural network, or agent, must perform a sequence of actions to resolve a task within its environment. These actions yield *rewards* that gauge the effectiveness of the network’s task performance. The network is then optimized to maximize its expected reward, i.e., performing the sequence of actions that lead to the highest task success. Noteworthy, the probability of action is called a policy in RL. In communication games, the sender produces a sequence of symbols to assist the receiver in completing a predetermined task. If this sequence leads to a successful outcome, the sender is rewarded positively; otherwise, it receives a negative reward. Through iterative trial and error, the sender refines its sequence of symbols toward maximizing its reward and ultimately solving the game, as further detailed in Section 2.3.2

Supervised learning is easy to apply and highly reproducible but requires a known target. On the other hand, reinforcement learning is more generic and only requires a score to be defined at the cost

of being more complex. For instance, to train a network to play chess, supervised learning would involve imitating the moves of a pro-player with a dataset (Silver et al., 2016), while reinforcement learning would require playing the whole game and rewarding victories: the training is more complex and slower, but it does not require data (Silver et al., 2017). It is noteworthy that the reinforcement learning reward can be defined arbitrarily, e.g., one may give an extra bonus when winning the game while preserving the queen, or it could also be used on top of a supervised training regime. This approach has been applied to train large dialogue systems (Ouyang et al., 2022) by imitating the human language and refining it with reinforcement learning.

**The loss function** Regardless of the learning technique, the task’s success is optimized by introducing a proxy, the *loss function*  $l(f_\theta; x, y)$ . The goal is then to find weights  $\theta$  such that the neural network  $f_\theta$  minimizes the average loss function  $\mathcal{L}_\theta$  over the entire training dataset  $\mathcal{D}_{train}$ :

$$\min_{\theta} \mathcal{L}_\theta, \quad \text{where: } \mathcal{L}_\theta = \mathbb{E}_{(x,y) \sim \mathcal{D}_{train}} [l(f_\theta; x, y)] \quad (1)$$

Loss functions vary depending on the network output and the training task (Bishop, 2006; Goodfellow et al., 2016). In supervised classification tasks, the Cross-Entropy loss is commonly used to measure the difference between the predicted class probabilities and the true class labels. For supervised regression tasks, the Mean Squared Error loss is typically employed to measure the difference between predicted and true values. In reinforcement learning, the losses often include the TD error or the score function (Sutton and Barto, 2018), which converts the expected sum of rewards as a training objective. In communication games, we often use either a cross-entropy error for the listener or the score function for the speaker. For instance, the cross-entropy would quantify the error of selecting the wrong object in a referential game. In contrast, the score function would quantify how the speaker policy, i.e., emergent language, should be modified according to the collected rewards to solve the task. We explain further these intuitions in Section 2.3.2.

**Optimizing the loss function** The loss function is reduced using a learning process that involves a series of updates known as *Gradient Descent* updates (Rumelhart et al., 1986). They iteratively adjust the network’s parameters by following the loss gradient. The magnitude of the update is controlled by a hyperparameter  $\eta$  called the *learning rate*. Given the optimization problem 1, the goal is to find weights such that the loss gradient equals 0. This is achieved by repeating the following gradient update rule:

$$\theta_{n+1} = \theta_n - \eta \nabla_{\theta} \mathcal{L}_\theta |_{\theta_n} \quad (2)$$

where  $\theta_n$  and  $\theta_{n+1}$  are the model parameters respectively at iteration  $n$  and  $n + 1$ ,  $\nabla_{\theta} \mathcal{L}_\theta$  the gradient of the loss function  $\mathcal{L}_\theta$  and  $\eta$  the learning rate.

In practice, computing the exact gradient of the averaged loss function  $\nabla_{\theta} \mathcal{L}_\theta$  is infeasible since it necessitates processing the complete dataset. *Stochastic Gradient Descent* (Bottou, 2010) overcomes this challenge by approximating the loss function gradient using a limited number of data samples, or *batches* at each iteration. In standard machine learning libraries (Bradbury et al., 2018; Paszke et al., 2019), *Stochastic Gradient Descent* updates are performed by pre-implemented methods referred to as *optimizers*. In communication games, this gradient is the mathematical operation that modifies the agent behavior. For instance, every single speaker update alters its generation of symbols, refining its emergent language step after step toward maximizing the reward objective.

**Good practice:** *What and how to choose training parameters ?*

1. **Choice of the learning rate** The learning rate controls how strongly a model is adjusted given the loss gradient. As illustrated in Figure 9, a too-small learning rate may induce ineffective learning, and a too-large learning rate may cause counter-productive (or even detrimental) (Goodfellow et al., 2016) updates. Fortunately, adaptive optimizer algorithms

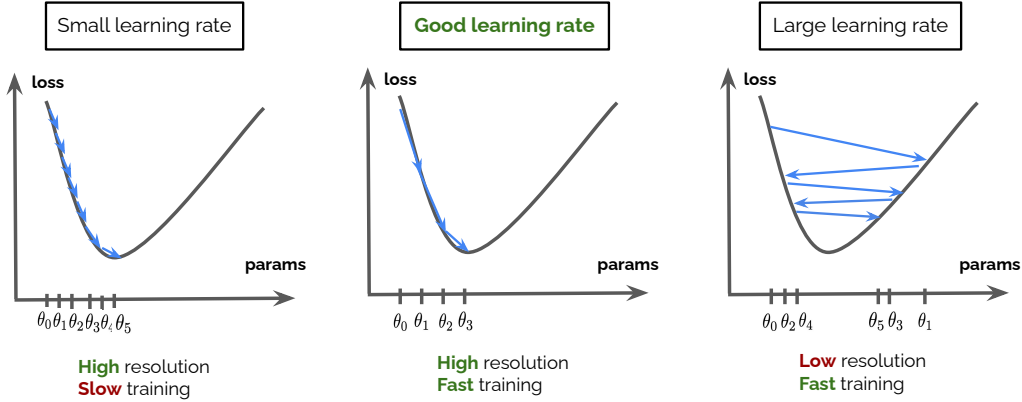

Figure 9: 1D representation of the effect of adjusting the learning rate. (a) Small learning rate: parameter updates are too parsimonious; the optimum may be attained, but it requires a large number of updates; (b) Adequate learning rate: the optimum may be reached with precision while limiting the number of updates; (c) Large learning rate: the training may be initially faster but lack the precision to reach the minimum leading to an oscillatory, and sometimes destructive, effect.

are designed to tune the learning rate during training. Typically, the learning rate starts large to kickstart the training and is gradually reduced toward the end for fine-tuning. An effective generic choice is to use optimizer *Adam* (Kingma and Ba, 2014) optimizer with an initial learning rate of  $4.10^{-3}$ .

2. **Choice of batch size** The batch size controls the gradient update accuracy. Counter-intuitively, a large batch size may not guarantee optimal performance. In supervised training, a batch size of 64 to 512 samples is often recommended, while in reinforcement learning, larger batch sizes of 256 to 4096 samples are preferred.
3. **Balancing batch sizes and learning rates** The batch size and learning rate values are correlated, with no straightforward recipe for interleaving them. It is often worth jointly sweeping over those two hyperparameters to boost performance.

**Generalization and overfitting** Training a model involves minimizing the loss of the training data, but evaluating its performance on unseen data is crucial to ensure the network’s quality. Intuitively, it is like creating an exam for students with unseen exercises to ensure they correctly understand the lecture. ML Practitioners distinguish (1) the training dataset  $\mathcal{D}_{train}$  and its corresponding loss  $\mathcal{L}_{train}$ , (2) the test dataset  $\mathcal{D}_{test}$  with unseen samples and its corresponding loss  $\mathcal{L}_{test}$ . The relation between the two losses indicates how well the model generalizes and can be trusted. Figure 10 illustrates the three regimes that may occur when training a model:

- **Underfitting:** Both  $\mathcal{L}_{train}$  and  $\mathcal{L}_{test}$  are high, indicating ineffective learning. An under-parametrized network or a small learning rate may cause persistent under-fitting. In communication games, this scenario arises when no successful communication emerges between the sender and receiver, resulting in a poor task success both on  $\mathcal{D}_{train}$  and  $\mathcal{D}_{test}$ .
- **Generalization:** Both  $\mathcal{L}_{train}$  and  $\mathcal{L}_{test}$  are low, indicating successful training and generalization. In communication games, this regime occurs when agents develop a successful communication on  $\mathcal{D}_{train}$  that generalizes well to an unseen dataset  $\mathcal{D}_{test}$ , resulting in high task success both on  $\mathcal{D}_{train}$  and  $\mathcal{D}_{test}$ .
- **Overfitting:**  $\mathcal{L}_{train}$  is low, but  $\mathcal{L}_{test}$  is high, indicating that the network has recorded the training data and is not able to generalize well to new data. This can be addressed by in-

creasing the amount of training data or using regularization techniques, as explained below. In communication games, this regime occurs when agents develop effective communication on  $\mathcal{D}_{train}$  but fail to generalize to an unseen dataset  $\mathcal{D}_{test}$ .

In communication games, the underfitting regime occurs when the emergent language is not powerful enough to resolve the task, i.e., similar sequences of symbols may represent completely different concepts. Conversely, overfitting occurs when a unique sequence of symbols defines each concept without any structure or compositionally. Therefore, there is no generalization beyond the concepts observed at training time. Optimally, we expect the emergent language to generalize to unseen concepts, which may result from emerging compositionality (Kirby, 2001; Rita et al., 2022b).

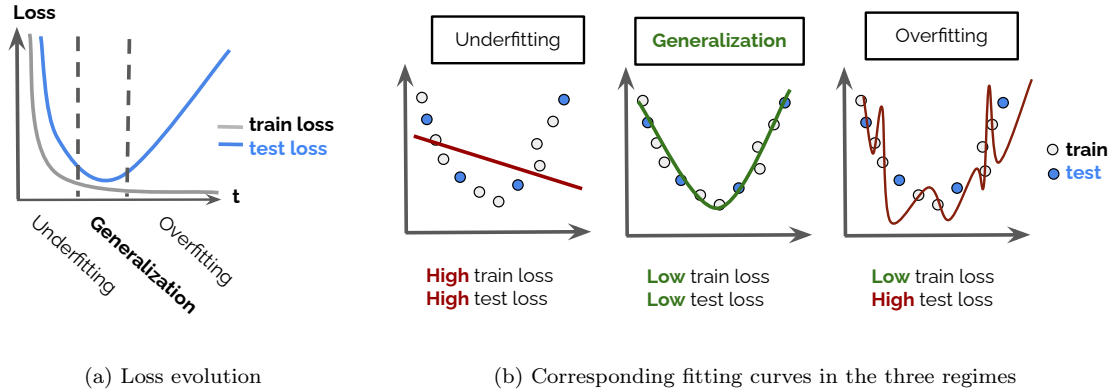

Figure 10: Training regimes for a 1D regression problem trained with the Mean-Squared Error Loss. During training, there are three phases: **underfitting**: both the train and test loss are high, and the corresponding fitting curve does not match nor the training data nor the test data; **generalization**: both the train and test loss are low, and the fitting curve matches both the training and test data; **overfitting**: the training loss remains low, but the test loss increases and the corresponding fitting curve perfectly matches the training data but does not generalize to the test data.

**Monitoring training** When training a model, it is recommended to divide the dataset into three parts:  $\mathcal{D}_{train}$ ,  $\mathcal{D}_{val}$ ,  $\mathcal{D}_{test}$  (typical proportion 80/10/10).  $\mathcal{D}_{train}$  is used to train the model,  $\mathcal{D}_{val}$  to find the generalization regime, tune hyperparameters, and retrieve the best model across training,  $\mathcal{D}_{test}$  is used to test the model and report the final score. Intuitively, validation data is similar to mock exams, whereas test data is the actual network exam. In practice, the validation loss is regularly plotted and when it starts increasing, training is stopped (Bishop, 2006). This technique is known as *Early stopping*.

**Regularization methods** Regularization methods were developed to prevent potential overfitting (Goodfellow et al., 2016), as the number of network parameters can be much larger than the data. Some of the most common techniques include:

- **Weight decay**: Overfitting may be caused by excessively increasing parameters. A weight decay penalty can be applied to the training loss. Using the AdamW variant of the Adam optimizer is recommended to ensure proper integration of the weight penalty (Loshchilov and Hutter, 2017).
- **Clipping**: Overfitting may be caused by destructive updates due to unexpected large loss gradients. Clipping methods are applied to cope with such events (Pascanu et al., 2013).
- **Dropout**: Overfitting may be alleviated by only training subsections of networks for each update. This masking mechanism may be applied at the neuron level (Srivastava et al., 2014) or neural-block level for deep networks (Ghiasi et al., 2018).

- **Normalization layers:** High neural activation inside the network tends to deteriorate the training process and favor overfitting. Normalization layers were developed to recalibrate the neural activations, such as batch-normalization (Ioffe and Szegedy, 2015), which is a parametrized whitening layer, or layer-normalization (Ba et al., 2016).
- **Data augmentation:** As overfitting often spurs with the lack of data, a common practice is to artificially augment the training set by applying random transformations such as resizing, color alteration, or partial masking for image data (Ba et al., 2016).

**Remark:** Applying all regularization techniques simultaneously may seem appealing but can lead to conflicts. For instance, batch normalization should not be applied with dropout, weight decay should not be applied to batch normalization and layer normalization parameters, and strong data augmentations may impair generalization. There is no single rule: finding the right balance for regularization often requires trial and error.

**Summary :** Figure 11 summarizes the training process and the associated experimental choices.

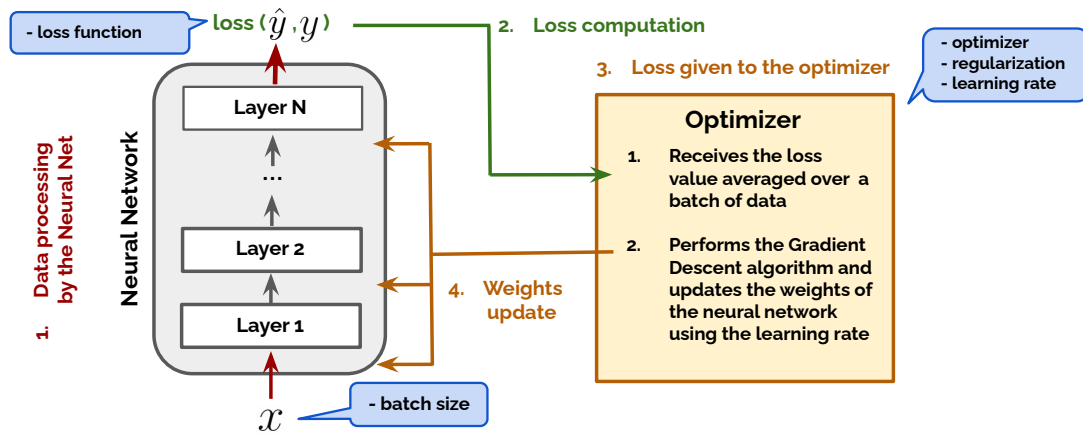

Figure 11: Updates cycle of a neural network in supervised learning. First, the neural network receives a batch of input  $x$ . The neural network then processes the data and outputs a prediction  $\hat{y}$ . Second, the loss function computes the average loss value by comparing  $\hat{y}$  to the ground truth output  $y$ . Third, the average loss value is fed to the optimizer. Last, the optimizer performs a Gradient Descent step to update the neural network weights based on the learning rate. All the experimental choices are framed in blue.

### 2.3.2 Optimizing communication games with machine learning

Unlike a single network training, two networks are trained simultaneously during a communication game, sometimes requiring different learning methods for each agent. The process involves selecting appropriate (1) learning methods, (2) rewards and loss functions, and (3) optimization protocols.

**Remark:** The machine learning community has developed frameworks for simulating various communication games, which can be rapidly replicated, understood, and modified. Existing codebases include (Kharitonov et al., 2019) and (Chaabouni et al., 2022) as long as the detailed notebook we provide.

**Learning methods** Three learning pipelines are mainly used to train agents in communication games:

1. **Both agents optimized with RL:** This generic and realistic setting assumes no specific task format and involves separate agents with individual rewards and training losses, making it suitable for training any task. However, such training is usually hard to optimize with high variance and requires careful use of RL tools we introduce later.

2. **Sender optimized with RL and Receiver optimized with SL:** This approach is well-suited for single-turn message games where the receiver only needs to perform one valid action after receiving a message, such as in referential games (Lewis, 1969; Skyrms, 2010). In such cases, the receiver’s action  $a$  is fully determined by the sender’s observation  $x_s$  and its message  $m$ , creating a supervised training sample  $(m, a)$  for the receiver. The receiver’s training becomes more robust by learning to map messages  $m$  to the corresponding output actions  $a$  using a supervised loss. Note that the sender still needs to be optimized with RL since message generation is non-differentiable, i.e., the receiver’s error cannot propagate to the sender. It ensures more stable training than using a pure RL reward-based approach.
3. **Both agents optimized with SL:** When both agents cooperate fully and optimize the same learning signal, they can be trained using a single supervised training signal. In this scenario, the Sender-Receiver couple is optimized as a single network that maps inputs  $x_s$  to output actions  $a$ , with a discrete intermediate layer. Reparametrization tricks such as Gumbel-Softmax (Jang et al., 2016; Maddison et al., 2016) have been developed to overcome the non-differentiability of message generation and allow the receiver’s error to flow to the sender<sup>2</sup>. Although this approach is more stable than RL methods, we won’t go into details because it assumes a less realistic training hypothesis, e.g., the exact error is propagated between sender and receiver as if they were mentally connected.

We next derive the case where agents are optimized with RL as it covers all communication tasks.

**Reward** Reward functions  $\mathcal{R}_s$  and  $\mathcal{R}_r$  must be defined to measure the success of the communication task for each agent. These functions typically take agents’ observations  $x_s$  and  $x_r$  and the receiver’s action  $a$  as input and return 1 if the task is solved, 0 otherwise.

**Remark:** The reward is the core element inducing the structure of the emergent language. Thus, we recommend carefully avoiding designing rewards toward obtaining a specific language, e.g., directly rewarding compositionality or syntactic properties. Instead, we suggest using rewards that measure communication success without any human prior. Hence, language features may emerge from solving a specific task rather than being forced by design.

The agents’ goal is to maximize their respective reward over time, i.e., the expected rewards:

$$\begin{cases} \mathbb{E}_{\tau \sim \text{game}(\pi_\theta, \rho_\phi)}[\mathcal{R}_s] & \text{Sender's expected reward} \\ \mathbb{E}_{\tau \sim \text{game}(\pi_\theta, \rho_\phi)}[\mathcal{R}_r] & \text{Receiver's expected reward} \end{cases} \quad (3)$$

$\tau \sim \text{game}(\pi_\theta, \rho_\phi)$  denotes a game episode that depends on the sender’s and receiver’s stochastic policies. The sender message  $m$  and the receiver’s action  $a$  are sampled from those distributions.

**Remark:**

- **Complete formalism:** A complete writing of the expectations should be:

$$\begin{cases} \mathbb{E}_{x_s \sim o_s, x_r \sim o_r, m \sim \pi_\theta(\cdot | x_s), a \sim \rho_\phi(\cdot | m, x_r)}[\mathcal{R}_s(x_s, x_r, a)] \\ \mathbb{E}_{x_s \sim o_s, x_r \sim o_r, m \sim \pi_\theta(\cdot | x_s), a \sim \rho_\phi(\cdot | m, x_r)}[\mathcal{R}_r(x_s, x_r, a)] \end{cases} \quad (4)$$

where the game is instantiated by sampling the initial agent observations  $x_s$  and  $x_r$ , the message  $m$  is sampled according to the sender’s policy  $\pi_\theta(\cdot | x_s)$  and the receiver’s action  $a$  is sampled according to its policy  $\rho_\phi(\cdot | m, x_r)$ .

- **Stochasticity:** Policy stochasticity is crucial in RL training as it enables the agent to explore its message/action space and learn from its errors. This implies that an object can be described by several messages, and a receiver may take different actions based on a given message.

<sup>2</sup>This is the same approach as training a Variational Auto-Encoder (VAE) (Kingma and Welling, 2013)

**Loss functions & gradient updates** In reinforcement learning, the goal is to minimize the expected negative reward. However, this objective cannot be directly turned into a gradient update as the reward is not differentiable by definition. Mathematical tools have been developed to circumvent this issue (Sutton and Barto, 2018). The policy-gradient algorithm (Sutton et al., 1999) is mostly used in neural language emergence. Denoting by  $\nabla_{\theta}\mathcal{L}_{\theta}$  and  $\nabla_{\phi}\mathcal{L}_{\phi}$  the sender and receiver’s respective loss gradient, we have:

$$\begin{cases} \nabla_{\theta}\mathcal{L}_{\theta} &= -\mathbb{E}_{\tau}[\nabla_{\theta}\log\pi_{\theta}(m|x_s)\mathcal{R}_s] & \text{sender's gradient} \\ \nabla_{\phi}\mathcal{L}_{\phi} &= -\mathbb{E}_{\tau}[\nabla_{\phi}\log\rho_{\phi}(a|m,x_r)\mathcal{R}_r] & \text{receiver's gradient} \end{cases} \quad (5)$$

In practice, the quantities (1)  $l_{\theta} = \log\pi_{\theta}(m|x_s)|\mathcal{R}_s|_{SG}$  and (2)  $l_{\phi} = \log\rho_{\phi}(a|m,x_r)|\mathcal{R}_r|_{SG}$  are computed over a batch of game episodes and passed to each agent optimizer.  $|\cdot|_{SG}$  is the stop gradient operator that prevents an optimizer from computing the gradient inside the operator.

**Optimizing the losses** The optimization encounters challenges, for which we provide a few recipes to ensure a successful optimization process:

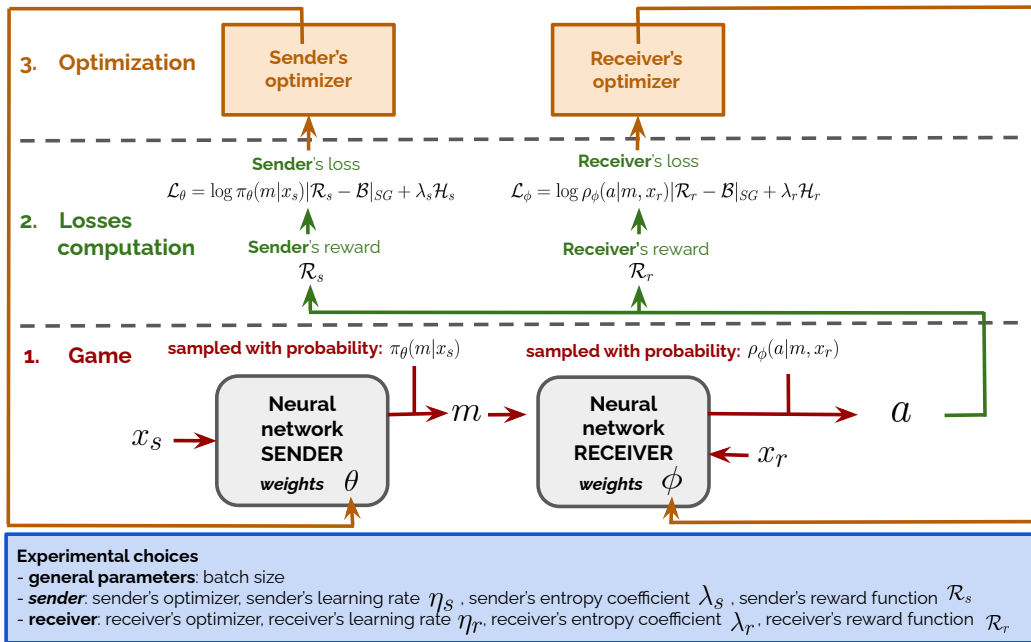

Figure 12: Scheme of the training loop of a communication game optimized with reinforcement learning. **Step 1 (game):** The sender and receiver perform an episode of the game on a batch of data. Agent’s observations  $x_s$  and  $x_r$ , receiver’s action  $a$ , the probabilities  $\pi_{\theta}(m|x_s)$  and  $\rho_{\phi}(a|m,x_r)$  with which the sender and receiver respectively samples the message  $m$  and performs action  $a$ , the entropy of the sender’s policy  $\mathcal{H}_s$  and receiver’s policy  $\mathcal{H}_r$  are kept to compute the losses. **Step 2 (losses computation):** Based on those quantities, we compute sender’s reward  $\mathcal{R}_s$  and receiver’s reward  $\mathcal{R}_r$  and then sender’s loss  $\mathcal{L}_{\theta}$  and receiver’s loss  $\mathcal{L}_{\phi}$ . **Step 3 (optimization):** We pass the losses to agents’ optimizers that update the weights of the two agents. All the experimental choices are framed in blue.

- Implementing Policy Gradient** While RL notations may become overwhelming for beginners, their implementation is quite straightforward in practice with recent machine learning libraries (Paszke et al., 2019; Bradbury et al., 2018).
- Dealing with large variance** Estimating the gradient of a RL loss is difficult due to the large variance of gradient estimates. Large batch sizes and the baseline method should be used to alleviate this. The latter implies subtracting a baseline  $\mathcal{B}$  from the reward  $\mathcal{R}$ , which does not bias the estimate while reducing the variance. A common baseline is the average value of the reward across a batch of data.

**3. Controlling the exploration-exploitation trade-off** To prevent the collapse of training due to sub-optimal average reward, one can control the exploitation-exploration trade-off by penalizing the entropy of the policies with the terms  $\lambda_s \mathcal{H}_s$  and  $\lambda_r \mathcal{H}_r$  ( $\mathcal{H}_s$  and  $\mathcal{H}_r$  refers to the entropy function applied on agents’ policies)<sup>3</sup>. By increasing the coefficient  $\lambda_s$  (resp.  $\lambda_r$ ), the sender’s policy (resp. receiver’s policy) is encouraged to explore multiple actions instead of focusing on single ones.

As summarized in Figure 11, the following optimization protocol can be built applying those practices:

- Choose a batch size and for each agent: learning rates  $\eta_s$  and  $\eta_r$ , reward functions  $\mathcal{R}_s$  and  $\mathcal{R}_r$ , exploration coefficients  $\lambda_s$  and  $\lambda_r$ ;
- Iteratively:
  1. Perform a game episode on a batch of data;
  2. Compute the losses:

$$\begin{cases} \log \pi_\theta(m|x_s)|\mathcal{R}_s - \mathcal{B}|_{SG} + \lambda_s \mathcal{H}_s & \text{Sender's loss} \\ \log \rho_\phi(a|m, x_r)|\mathcal{R}_r - \mathcal{B}|_{SG} + \lambda_r \mathcal{H}_r & \text{Receiver's loss} \end{cases}$$

3. Pass sender’s loss (resp. receiver’s loss) to sender’s optimizer (resp. receiver’s optimizer), which performs a parameters update for each agent.

**Remark:** Training a communication game involves selecting reward functions for each agent and tuning numerous parameters: the batch size, agents’ learning rate, and exploration coefficient. The initial step in a simulation is to identify a set of parameters that allows the agents to solve the task. However, it is essential to consider how these choices affect the system’s overall training dynamics. Rita et al. (2022a;b) demonstrate that optimization decisions, especially asymmetries between the sender and the receiver, crucially impact the properties of the emergent communication protocol.

### 3 Case study: Simulating a Visual Discrimination Game

We now focus on a particular communication game: the Visual Discrimination Game, a type of Lewis Referential Games (Lewis, 1969). These games, which explore how languages emerge through their use, have been extensively studied from theoretical and experimental angles in language evolution (Crawford and Sobel, 1982; Blume et al., 1998; Skyrms, 2010; Raviv et al., 2019).

**Game rules** The Visual Discrimination Game involves two players: a sender and a receiver. The game proceeds as follows:

- The sender sees an image and communicates about it to the receiver;
- Using the message, the receiver has to guess the original image seen by the sender among a set of  $N$  candidate images;
- The original image is revealed, and the two players are informed about the task’s success.

Agents play the game repeatedly until they synchronize on a communication protocol that enables the receiver to distinguish any image from any set of distractors.

<sup>3</sup> $\mathcal{H}_s = \mathcal{H}(\pi_\theta(\cdot|x))$  and  $\mathcal{H}_r = \mathcal{H}(\rho_\phi(\cdot|m, x_r))$  where  $\mathcal{H}$  is the entropy function



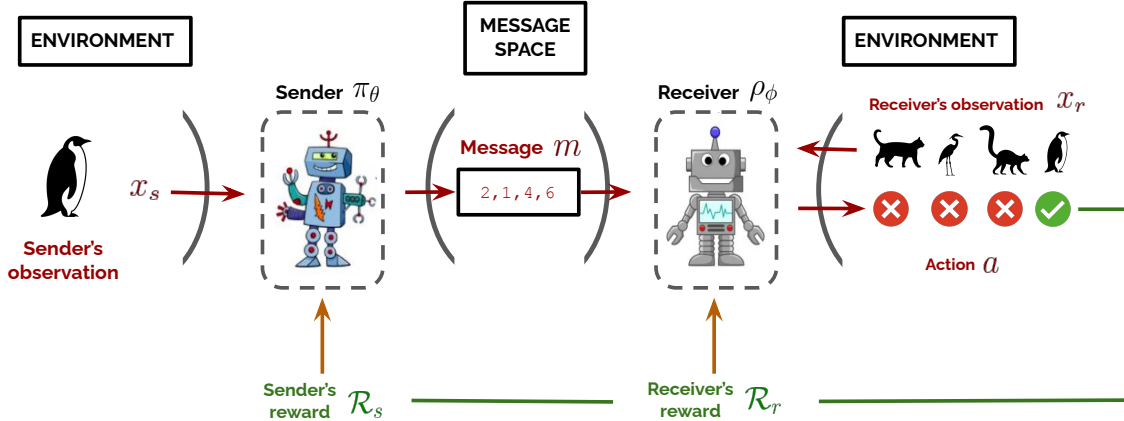

Figure 13: In the Visual Discrimination Game, the Sender sees an image (sender observation) and communicates about it to the receiver. Using the message, the receiver has to guess the target image among a set of  $N$  candidate images (receiver observation). If the guess (receiver action) is identical to the sender’s image, the two agents are equally rewarded

**Designing the game** The following parameters must be specified:

- **Image dataset** This is the set of images the agents must communicate about. Compared to human simulations, machine learning experiments can be conducted with large-scale datasets compared to human simulations, which is critical for developing a rich communication protocol. For example, some studies, such as Lazaridou et al. (2016); Dessì et al. (2021); Chaabouni et al. (2022); Rita et al. (2022b), have relied on ImageNet (Deng et al., 2009; Russakovsky et al., 2015) (14 million images dataset spanning more than 20,000 categories including animals, vehicles, objects or instruments). Synthetic datasets, like CLEVR (Johnson et al., 2017) are also valuable for evaluating agents’ ability to communicate about ambiguous images using compositional languages.
- **Number of candidate images  $N$**  The receiver must differentiate the original image from  $N - 1$  distractor images. The task’s difficulty depends on the value of  $N$ : a higher  $N$  requires a more precise communication protocol.
- **Message space** The message space is shaped by the vocabulary  $V$  and message maximum length  $L$ . Adjusting those parameters crucially influences the sender’s expressiveness. By denoting the vocabulary size by  $|V|$ , the sender can use a total number of  $L^{|V|}$  messages.

**Game formalism** Using previous notations:

- *Sender’s observation  $x_s$*  is an image sampled from the dataset.
- *Receiver’s observation  $x_r$*  is a set of  $N$  images sampled from the dataset that includes sender’s observation  $x_s$ .
- *Message  $m$*  is a message sent by the sender.
- *Action  $a$*  is the choice of image among the set of  $N$  images.

**Designing the network** Following agents design of Figure 8 and neural networks descriptions in Figure 7, Figure 14 reports standard agents design choices in the Visual Discrimination Game.

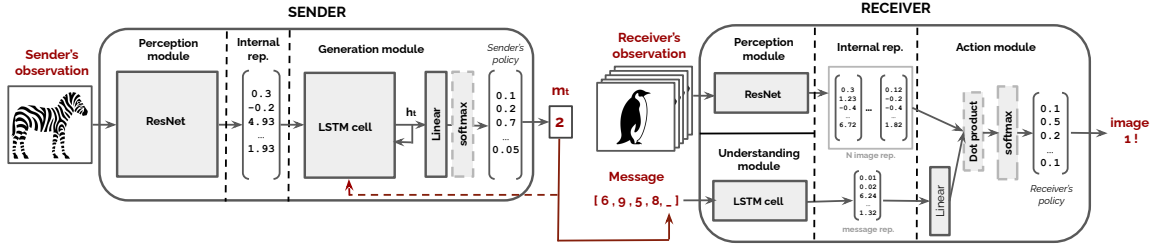

Figure 14: Examples of neural communicative agents in the Visual Discrimination Game. Module choices are based on the usual agent design from the literature.

(left) The sender uses a perception module and a generation module with an internal representation in between. The perception module is a ResNet (He et al., 2016), i.e., CNN with additional skip connections, which produces image representations. The generation module consists of a one-layer LSTM (Hochreiter and Schmidhuber, 1997), an RNN variant, followed by a linear layer and a softmax, which generates the sender’s policy (probability distribution over the vocabulary symbols). The output is obtained by recursively sampling symbols until the maximum length is reached or the end-of-sentence token is generated.

(right) The receiver comprises a perception module, an understanding module, and an action module with internal representations in between. Like the sender, the perception module is a ResNet, and the understanding module is a one-layer LSTM. The action module includes a linear layer that maps the message representation to a vector with the same dimension as image representations. This dot product compares each image representation to the message representation. Finally, a softmax transforms the resulting  $N$  values to probability distributions over the  $N$  possible actions. The action, i.e., image choice, is obtained by sampling according to this distribution.

### Good practice: *Scaling-up neural networks to natural inputs*

- **Pretrained Network:** Pre-trained modules are employed to simplify computation. These are neural networks that have been previously trained on a different task. In our example, a pre-trained network is used as a perception module, which is frozen during the training (Chaabouni et al., 2022; Rita et al., 2022b). It aims to provide meaningful image representations inherited from the previous task. Chaabouni et al. (2022) provide such pre-trained representations for the ImageNet (Deng et al., 2009; Russakovsky et al., 2015) and CelebA (Liu et al., 2015) datasets.
- **Multimodal Learning:** Fusing different inputs and outputs is referred to as Multimodal Learning (Baltrušaitis et al., 2018). For instance, the receiver needs message and image representations to perform an action. Simple methods like concatenation or scalar product are often used to fuse different neural module representations. When scaling up to more realistic tasks, more advanced fusing mechanisms are sometimes required, e.g., modulation (Dumoulin et al., 2018) or multi-modal transformers (Lu et al., 2019; Alayrac et al., 2022).

**Optimization** Using Figure 12 scheme, a working optimization algorithm using reinforcement learning only is described in Algorithm 1.

**Parameter choices** A typical reward function assigns a reward of 1 if the receiver picks up the correct image and 0 otherwise. The modeling parameters, which include the vocabulary  $V$ , maximum message length  $L$ , and the number of candidates  $N$ , should be selected based on the problem under investigation. For the optimization, we recommend using a large batch size (512 or 1024 typically) and one Adam (Kingma and Ba, 2014) optimizer per agent. The other parameters, including exploration coefficients  $\lambda_s$ ,  $\lambda_r$  and learning rates  $\eta_s$ ,  $\eta_r$  are interdependent and should be adjusted simultaneously until the simulation works. Common strategies for parameter tuning

---

**Algorithm 1** Visual Discrimination Game optimization

---

**Require:**  $\pi_\theta$  (sender),  $\rho_\phi$  (receiver) ▷ Trainable neural networks  
**Require:**  $\mathcal{D}_{train}$  (image dataset), `batch_size`,  $N$ ,  $V$ ,  $L$  ▷ General parameters  
**Require:** sender’s optimizer,  $\eta_s$ ,  $\mathcal{R}$ ,  $\lambda_s$ , ▷ Sender’s parameters  
**Require:** receiver’s optimizer,  $\eta_r$ ,  $\mathcal{R}$ ,  $\lambda_r$ , ▷ Receiver’s parameters

**while** convergence **do** ▷ **Learning loop**

**1. Game**

$x_s \sim \mathcal{D}_{train}, x_r \sim \mathcal{D}_{train}$  ▷ Images sampled from the dataset  
         $\tau \sim \text{game}(\pi_\theta, \rho_\phi, x_s, x_r, V, L)$  ▷ Game episode (batch\_size games in parallel)

**2. Losses computation**

$\mathcal{R} \leftarrow f_{reward}(\tau)$  ▷ Reward computation  
         $\mathcal{L}_s \leftarrow \log \pi_\theta(m|x_s)|\mathcal{R} - \mathcal{B}|_{SG} + \lambda_s \mathcal{H}_s$  ▷ Sender’s loss  
         $\mathcal{L}_r \leftarrow \log \rho_\phi(a|m, x_r)|\mathcal{R} - \mathcal{B}|_{SG} + \lambda_r \mathcal{H}_r$  ▷ Receiver’s loss

**3. Optimizer**

$\theta \leftarrow \text{sender’s optimizer}(\theta, \eta_s, \mathcal{L}_s)$  ▷ Sender’s weights update  
         $\phi \leftarrow \text{receiver’s optimizer}(\theta, \eta_r, \mathcal{L}_r)$  ▷ Receiver’s weights update

**end while**

---

include manual adjustment or more systematic methods like grid search (Feurer and Hutter, 2019).

**Implementation** A full implementation of the game with technical details and a starting set of working parameters is provided at:

[https://github.com/MathieuRita/LangageEvolution\\_with\\_DeepLearning](https://github.com/MathieuRita/LangageEvolution_with_DeepLearning)

## 4 Bridging the gap between neural networks and humans in language evolution simulations

This section focuses on current endeavors in using deep learning as a framework for language evolution simulations. It covers the field’s progress in using neural networks to replicate human languages and highlights the potential and challenges of deep learning simulations.

### 4.1 Opportunities opened by deep learning simulations

**The control/realism duality of simulations** Neural network simulations provide extensive flexibility for modeling various aspects of language emergence simulations, including the game, inputs, and agents. Two primary strategies have been pursued: simplifying experiments into controllable settings (Kottur et al., 2017; Chaabouni et al., 2019; 2020; Ren et al., 2020; Rita et al., 2022a), assessing the influence of incremental modeling elements; and creating more humanly plausible scenarios that emulate language emergence in complex environments (Das et al., 2019; Jaques et al., 2019). It has resulted in various tasks, from basic referential tasks to complex ecological tasks in grounded environments (Das et al., 2019). In terms of inputs, it spans from hand-designed structured and controllable inputs (Kottur et al., 2017; Chaabouni et al., 2019; 2020; Ren et al., 2020; Rita et al., 2020; 2022a) to complicated visual inputs (Evtimova et al., 2017; Lazaridou et al., 2018; Dessì et al., 2021; Chaabouni et al., 2022; Rita et al., 2022b). As for agents, it extends from pairs of agents decomposed into senders and receivers to pairs of bidirectional agents (Bouchacourt and Baroni, 2018; Graesser et al., 2019; Taillandier et al., 2023; Michel et al., 2023) and populations (Tieleman et al., 2019; Graesser et al., 2019; Rita et al., 2022a; Michel et al., 2023).

**Evaluating emergent linguistic phenomena** Simulations give rise to the emergence of artificial languages whose properties are compared to human languages. As human languages can be described in terms of language universals, i.e., abstract properties found across all human languages, studies have tried to establish the conditions under which those universal properties emerge. Such universals mainly include compositionality, i.e., the ability to decompose the meaning of an utterance as a function of its constituents (Hockett, 1960), measured through topographic similarity (Brighton and Kirby, 2006), (Chaabouni et al., 2020), or Tree Reconstruction Error (Andreas, 2019); efficiency, i.e., efficient information compression, measured through message length statistics and semantic categorization (Zipf, 1949; Regier et al., 2015); demographic trends, such as the impact of population size, contact agents proportion, network topology on language structure (Clyne, 1992; Wray and Grace, 2007; Wagner, 2009; Gary Lupyan, 2010).

## 4.2 Do neural networks replicate human behaviors?

To provide valuable insights through deep learning simulations, replicating human languages is essential. This involves identifying the basic assumptions needed for artificial agents to display human-like language patterns in their communication protocols.

### **The referential objective is insufficient for the emergence of natural language features**

A first approach is to question whether the most simple communication task, i.e., referring to objects in an environment through referential communication, is enough to see human language features emerge. The first works on referential tasks showed that neural agents could successfully derive a communication protocol from solving the task (Kottur et al., 2017; Lazaridou et al., 2016; Havrylov and Titov, 2017). Still, such protocols are neither interpretable nor bear the core properties of human languages. Indeed, agents tasked with communicating about images do not utilize semantically significant concepts but instead shortcut the task by basing their messages on low-level visual features (Lazaridou et al., 2016; Havrylov and Titov, 2017; Chaabouni et al., 2022; Bouchacourt and Baroni, 2018). Additionally, when agents communicate about hand-designed structured sets of objects in a simple referential task, fundamental properties of natural languages such as compositionality (Kottur et al., 2017; Chaabouni et al., 2020) or efficiency (Zipf, 2016) do not spontaneously arise (Chaabouni et al., 2019). Eventually, when referential games are played within a population of agents, human demographic trends are not reproduced. Population size does not behave as a regularization factor (Li and Bowling, 2019; Cogswell et al., 2019; Rita et al., 2022a; Chaabouni et al., 2022) and agents do not synchronize on a shared protocol (Rita et al., 2022a; Michel et al., 2023). Understanding the origins of these discrepancies from either an optimization or modelization perspective is an active research question.

### **Incorporating human-inspired constraints drive the emergence of natural language features**

To recover human languages features, different human-inspired constraints have incrementally been added to simulations. Inspired by Iterated Learning (Kirby, 2001; Kirby et al., 2014), one line of research has explored the effects of learnability constraints on language emergence by altering learning dynamics. Li and Bowling (2019); Ren et al. (2020); Cogswell et al. (2019) implement neural variants of Iterated Learning by periodically introducing newborn agents and mimicking generational transmission. They find that those learning constraints drive the selection of more compositional languages, as they are easier to learn (Li and Bowling, 2019). Another line of research focuses on incorporating cognitively inspired biases into agent modeling. For example, Rita et al. (2020) show that Zipf’s Law of Abbreviation (Zipf, 1949) emerges when both pressures toward Least Effort production (Zipf, 1949; Piantadosi et al., 2011; Kanwal et al., 2017) and comprehension laziness are introduced. Eventually, some researchers have refined population modeling. Rita et al. (2022a) introduce learning speed variations into populations and recover the relationship between population size and language structure reported in previous works (Gary Lupyan, 2010; Meir et al., 2012; Dryer and Haspelmath, 2013; Reali et al., 2018; Raviv et al., 2019). Graesser et al. (2019) examine contact agents phenomena and show that a contact language can either converge towards the majority protocol or result in novel creole languages, depending on the inter- and intra-community

densities. [Kim and Oh \(2021\)](#) and [Michel et al. \(2023\)](#) study how social graph connectivity impacts the development of shared languages.

### 4.3 Toward realistic experiments

Although incorporating human-inspired constraints shows promise for replicating human language features, the simplicity of current models remains limited. An avenue is opened for the design of humanly plausible experiments. We present efforts to build more realistic models and discuss the associated challenges here.

**Toward realistic scenarios** Task-specific communication games may be restrictive as they overlook other aspects of our language, such as conversation, interaction with the physical world, and other modalities. More realistic scenarios are needed to encompass all aspects of our language. Some attempts have been made to create more plausible settings. [Chaabouni et al. \(2022\)](#) complexify the referential task by scaling the game to large datasets and tasking agents to retrieve images among 1000 distractors. [Evtimova et al. \(2017\)](#); [Taillandier et al. \(2023\)](#) model conversation by building bidirectional agents for multi-turn communications; [Bullard et al. \(2020\)](#) explore nonverbal communication using spatially articulated agents; ([Das et al., 2019](#)) ground agents in more realistic 2D and 3D environments; [Jaques et al. \(2019\)](#) test agents ability to solve social dilemmas in grounded environments. However, making more realistic games poses both technical and analytical challenges. Training instabilities can occur when games become more complex, requiring optimization tricks ([Chaabouni et al., 2022](#)). Moreover, as environments become more complex, the emergence of language is more challenging to analyze. For example, [Lowe et al. \(2020\)](#) demonstrates how agents can solve complex tasks with shallow communication protocols and why new tools are needed to assess emergent languages qualitatively and quantitatively in these situations.

**Toward realistic agents** Many neural communication agents are designed for specific games and lack crucial aspects of human cognition. For instance, agents are often limited to either speaking or listening, which overlooks the interplay between comprehension and production ([Galke et al., 2022](#)). Some works propose more realistic agents. These include bidirectional agents that both speak and listen ([Bouchacourt and Baroni, 2018](#); [Graesser et al., 2019](#); [Michel et al., 2023](#); [Taillandier et al., 2023](#)), as well as agents with restricted memory capacity that better mirrors human cognition ([Resnick et al., 2019](#)). Additionally, [Rita et al. \(2020\)](#) incorporate the Least Effort Principle to make agents efficient encoders ([Zipf, 1949](#); [Piantadosi et al., 2011](#); [Kanwal et al., 2017](#)). Still, despite the impact of these modeling constraints on emergent language properties, they are not consistently applied across the literature.

**Toward linguistically informed metrics** One of the main limitations of neural emergent languages is that current metrics may not capture crucial features of human languages. For instance, most work only uses topographic similarity ([Lazaridou et al., 2018](#); [Li and Bowling, 2019](#)) as a structural metric ([Brighton and Kirby, 2006](#)), which assumes that the units of the message carry out the meaning. In human languages, the meaning units are the results of a combinatorial process using nonmeaningful units, such as phonetic features or phonemes (the so-called double articulation phenomenon ([Martinet, 1960](#)); or duality of patterning ([Hockett, 1970](#))). Other universal properties of language (formal universals ([Chomsky and Halle, 1968](#))) include the reliance on symbols and rules ([Fodor and Pylyshyn, 1988](#)), the use of hierarchical representations or long distance dependencies ([Hauser et al., 2002](#)), the existence of part-of-speech classes ([Rijkhoff, 2007](#)) such as the distinction between content and grammatical words, the existence of deixis ([Lyons, 1977](#)), i.e. the use of certain parts of the message to refer to places or time or person relative to the context of elocution of the message, and many others. Studying such properties is challenging as it requires the design of adapted measures that could be computed both on human and artificial languages. Furthermore, current artificial settings are often too simple to drive the emergence of such properties, reinforcing the need for more realistic scenarios that translate into our environment’s complexity.

**Bridging Natural Language Processing and Language Emergence** One area of research focuses on investigating whether language emergence simulations can potentially enhance natural language processing tasks. One approach involves pre-training language models with artificial languages that emerged from communication games, resulting in a moderate boost when fine-tuning low-resource language tasks (Yao et al., 2022). Another approach is exploring machine-machine interaction to learn an emergent communication protocol that prompts large language models (Shin et al., 2020; Deng et al., 2022). Reciprocally, natural language models can be utilized to explore language evolution from pre-trained languages, such as studying creolization (Armstrong et al., 2022) or language drift phenomena (Lu et al., 2020). Finally, at the time of writing, Large Language Models (LLM) (Ouyang et al., 2022; Hoffmann et al., 2022b; Touvron et al., 2023; Bai et al., 2022) have demonstrated potential for Natural Language Processing, as they can handle multiple languages and perform basic reasoning. This presents exciting opportunities for language emergence research from scientific and practical perspectives (Baroni et al., 2022).

## 5 Conclusion

Deep learning advancements offer new opportunities for simulating language evolution, as neural networks can handle diverse data without pre-defined human priors. They scale significantly regarding dataset size, task complexity, and number of participants or generations. This opens up possibilities for creating realistic language evolution scenarios at unprecedented scales. Reciprocally, language evolution research can provide valuable insights for developing future deep learning models. In the journey toward building intelligent language models, it seems essential to incorporate constraints and mechanisms that shape the development and evolution of language, such as perceptual, social, or environmental pressures. We hope this chapter will encourage researchers in both language evolution and deep learning to collaborate and jointly explore those two captivating black-boxes: humans and neural networks.

## References

- Marc D Hauser. *The evolution of communication*. MIT press, 1996. 1
- Marc D Hauser, Noam Chomsky, and W Tecumseh Fitch. The faculty of language: what is it, who has it, and how did it evolve? *science*, 298(5598):1569–1579, 2002. 1, 21
- Stevan Harnad, Horst Dieter Steklis, and Jane Beckman Lancaster. Origins and evolution of language and speech. *Language*, 54(3):647–660, 1976. doi: 10.1352. 1
- Derek Bickerton. Language evolution: A brief guide for linguists. *Lingua*, 117(3):510–526, 2007. 1
- Luc Steels. The synthetic modeling of language origins. *Evolution of communication*, 1(1):1–34, 1997. 1
- Carol Myers-Scotton. *Contact Linguistics: Bilingual Encounters and Grammatical Outcomes*. Oxford University Press, Oxford, UK, 2002. 1
- Simon Kirby. Natural language from artificial life. *Artificial life*, 8(2):185–215, 2002. 1
- Simon Kirby, Hannah Cornish, and Kenny Smith. Cumulative cultural evolution in the laboratory: An experimental approach to the origins of structure in human language. *Proceedings of the National Academy of Sciences*, 105(31):10681–10686, 2008. 1, 2
- Limor Raviv, Antje Meyer, and Shiri Lev-Ari. Larger communities create more systematic languages. *Proceedings of the Royal Society B*, 286(1907):20191262, 2019. 1, 2, 16, 20
- Yasamin Motamedi, Marieke Schouwstra, Kenny Smith, Jennifer Culbertson, and Simon Kirby. Evolving artificial sign languages in the lab: From improvised gesture to systematic sign. *Cognition*, 192:103964, 2019. 1

- Philip Lieberman and Edmund S Crelin. On the speech of neanderthal man. *JANUA LINGUARUM*, page 76, 1971. [1](#)
- James R Hurford. Biological evolution of the saussurean sign as a component of the language acquisition device. *Lingua*, 77(2):187–222, 1989. [2](#)
- Luc Steels. A self-organizing spatial vocabulary. *Artificial life*, 2(3):319–332, 1995. [2](#)
- Florenca Reali and Thomas L Griffiths. The evolution of frequency distributions: Relating regularization to inductive biases through iterated learning. *Cognition*, 111(3):317–328, 2009. [2](#)
- Florenca Reali and Thomas L Griffiths. Words as alleles: connecting language evolution with bayesian learners to models of genetic drift. *Proceedings of the Royal Society B: Biological Sciences*, 277(1680):429–436, 2010. [2](#)
- Kenny Smith, Henry Brighton, and Simon Kirby. Complex systems in language evolution: the cultural emergence of compositional structure. *Advances in complex systems*, 6(04):537–558, 2003. [2](#)
- Paul Vogt. Modeling interactions between language evolution and demography. *Human biology*, 81(3):237–258, 2009. [2](#)
- Tao Gong, Lan Shuai, and Menghan Zhang. Modelling language evolution: Examples and predictions. *Physics of life reviews*, 11(2):280–302, 2014. [2](#)
- Jinyun Ke, Tao Gong, William SY Wang, et al. Language change and social networks. *Communications in Computational Physics*, 3(4):935–949, 2008. [2](#)
- Lewys Brace, Seth Bullock, and Jason Noble. Achieving compositional language in a population of iterated learners. In *ECAL 2015: the 13th European Conference on Artificial Life*, pages 349–356. MIT Press, 2015. [2](#)
- Christine Cuskley, Claudio Castellano, Francesca Colaiori, Vittorio Loreto, Martina Pugliese, and Francesca Tria. The regularity game: Investigating linguistic rule dynamics in a population of interacting agents. *Cognition*, 159:25–32, 2017. [2](#)
- Simon Kirby, Monica Tamariz, Hannah Cornish, and Kenny Smith. Compression and communication in the cultural evolution of linguistic structure. *Cognition*, 141:87–102, 2015. [2](#)
- Kaiming He, Xiangyu Zhang, Shaoqing Ren, and Jian Sun. Deep residual learning for image recognition. In *Proceedings of the IEEE conference on computer vision and pattern recognition*, pages 770–778, 2016. [2](#), [18](#)
- Ting Chen, Simon Kornblith, Mohammad Norouzi, and Geoffrey Hinton. A simple framework for contrastive learning of visual representations. In *International conference on machine learning*, pages 1597–1607. PMLR, 2020. [2](#)
- Jacob Devlin, Ming-Wei Chang, Kenton Lee, and Kristina Toutanova. Bert: Pre-training of deep bidirectional transformers for language understanding. *arXiv preprint arXiv:1810.04805*, 2018. [2](#)
- Tom Brown, Benjamin Mann, Nick Ryder, Melanie Subbiah, Jared D Kaplan, Prafulla Dhariwal, Arvind Neelakantan, Pranav Shyam, Girish Sastry, Amanda Askell, et al. Language models are few-shot learners. *Advances in neural information processing systems*, 33:1877–1901, 2020. [2](#), [7](#)
- Dzmitry Bahdanau, Kyunghyun Cho, and Yoshua Bengio. Neural machine translation by jointly learning to align and translate. *arXiv preprint arXiv:1409.0473*, 2014. [2](#)
- Ashish Vaswani, Noam Shazeer, Niki Parmar, Jakob Uszkoreit, Llion Jones, Aidan N Gomez, Łukasz Kaiser, and Illia Polosukhin. Attention is all you need. *Advances in neural information processing systems*, 30, 2017. [2](#), [7](#), [8](#)

- David Silver, Aja Huang, Chris J Maddison, Arthur Guez, Laurent Sifre, George Van Den Driessche, Julian Schrittwieser, Ioannis Antonoglou, Veda Panneershelvam, Marc Lanctot, et al. Mastering the game of go with deep neural networks and tree search. *nature*, 529(7587):484–489, 2016. [2](#), [10](#)
- Satwik Kottur, José MF Moura, Stefan Lee, and Dhruv Batra. Natural language does not emerge ‘naturally’ in multi-agent dialog. *arXiv preprint arXiv:1706.08502*, 2017. [2](#), [8](#), [19](#), [20](#)
- Angeliki Lazaridou, Karl Moritz Hermann, Karl Tuyls, and Stephen Clark. Emergence of linguistic communication from referential games with symbolic and pixel input. *arXiv preprint arXiv:1804.03984*, 2018. [2](#), [8](#), [19](#), [21](#)
- Angeliki Lazaridou and Marco Baroni. Emergent multi-agent communication in the deep learning era. *arXiv preprint arXiv:2006.02419*, 2020. [2](#)
- David Kellogg Lewis. *Convention: A Philosophical Study*. Cambridge, MA, USA: Wiley-Blackwell, 1969. [2](#), [3](#), [14](#), [16](#)
- Andrea Baronchelli, Tao Gong, Andrea Puglisi, and Vittorio Loreto. Modeling the emergence of universality in color naming patterns. *Proceedings of the National Academy of Sciences*, 107(6):2403–2407, 2010. [2](#)
- Thomas M. Mitchell. *Machine Learning*. McGraw-Hill, Inc., New York, NY, USA, 1 edition, 1997. [2](#)
- Steven Tadelis. *Game theory: an introduction*. Princeton university press, 2013. [2](#)
- Vincent P Crawford and Joel Sobel. Strategic information transmission. *Econometrica: Journal of the Econometric Society*, pages 1431–1451, 1982. [2](#), [16](#)
- Brian Skyrms. *Signals: Evolution, learning, and information*. OUP Oxford, 2010. [2](#), [14](#), [16](#)
- Claude E Shannon. A mathematical theory of communication. *The Bell system technical journal*, 27(3):379–423, 1948. [3](#)
- John C Harsanyi. Games with incomplete information played by “bayesian” players, i–iii part i. the basic model. *Management science*, 14(3):159–182, 1967. [3](#)
- In-Koo Cho and David M. Kreps. Signaling Games and Stable Equilibria\*. *The Quarterly Journal of Economics*, 102(2):179–221, 05 1987. ISSN 0033-5533. doi: 10.2307/1885060. URL <https://doi.org/10.2307/1885060>. [3](#)
- Michael L Littman. Markov games as a framework for multi-agent reinforcement learning. In *Machine learning proceedings 1994*, pages 157–163. Elsevier, 1994. [4](#)
- Aleksandra Kalinowska, Elnaz Davoodi, Florian Strub, Kory W Mathewson, Ivana Kajic, Michael Bowling, Todd D Murphey, and Patrick M Pilarski. Over-communicate no more: Situated rl agents learn concise communication protocols. *arXiv preprint arXiv:2211.01480*, 2022. [4](#)
- Micah Carroll, Rohin Shah, Mark K Ho, Tom Griffiths, Sanjit Seshia, Pieter Abbeel, and Anca Dragan. On the utility of learning about humans for human-ai coordination. *Advances in neural information processing systems*, 32, 2019. [4](#)
- Natasha Jaques, Angeliki Lazaridou, Edward Hughes, Caglar Gulcehre, Pedro Ortega, DJ Strouse, Joel Z Leibo, and Nando De Freitas. Social influence as intrinsic motivation for multi-agent deep reinforcement learning. In *International conference on machine learning*, pages 3040–3049. PMLR, 2019. [4](#), [19](#), [21](#)
- Adam Paszke, Sam Gross, Soumith Chintala, Gregory Chanan, Edward Yang, Zachary DeVito, Zeming Lin, Alban Desmaison, Luca Antiga, and Adam Lerer. Automatic differentiation in pytorch. In *Proc. of Advances in Neural Information Processing Systems (NeurIPS)*, 2017. [5](#)



- James Bradbury, Roy Frostig, Peter Hawkins, Matthew James Johnson, Chris Leary, Dougal Maclaurin, George Necula, Adam Paszke, Jake VanderPlas, Skye Wanderman-Milne, and Qiao Zhang. JAX: composable transformations of Python+NumPy programs, 2018. URL <http://github.com/google/jax>. 5, 10, 15
- Yann LeCun, Léon Bottou, Yoshua Bengio, and Patrick Haffner. Gradient-based learning applied to document recognition. *Proceedings of the IEEE*, 86(11):2278–2324, 1998. 6
- Vinod Nair and Geoffrey E Hinton. Rectified linear units improve restricted boltzmann machines. In *Proceedings of the 27th international conference on machine learning (ICML-10)*, pages 807–814, 2010. 6
- Kurt Hornik, Maxwell Stinchcombe, and Halbert White. Multilayer feedforward networks are universal approximators. *Neural networks*, 2(5):359–366, 1989. 6
- Thomas N Kipf and Max Welling. Semi-supervised classification with graph convolutional networks. *arXiv preprint arXiv:1609.02907*, 2016. 7
- Frank Rosenblatt. The perceptron: a probabilistic model for information storage and organization in the brain. *Psychological review*, 65(6):386, 1958. 7
- Yann LeCun, D Touresky, G Hinton, and T Sejnowski. A theoretical framework for back-propagation. In *Proceedings of the 1988 connectionist models summer school*, volume 1, pages 21–28, 1988. 7, 8
- Kunihiko Fukushima. Neocognitron: A self-organizing neural network model for a mechanism of pattern recognition unaffected by shift in position. *Biological cybernetics*, 36(4):193–202, 1980. 7
- Jeffrey L Elman. Finding structure in time. *Cognitive science*, 14(2):179–211, 1990. 7, 8
- Tomas Mikolov, Martin Karafiát, Lukas Burget, Jan Cernocký, and Sanjeev Khudanpur. Recurrent neural network based language model. In *Interspeech*, pages 1045–1048, 2010. 7, 8
- Ilya Sutskever, James Martens, and Geoffrey E Hinton. Generating text with recurrent neural networks. In *ICML*, 2011. 7
- Sepp Hochreiter and Jürgen Schmidhuber. Long short-term memory. *Neural computation*, 9(8):1735–1780, 1997. 7, 18
- Junyoung Chung, Caglar Gulcehre, KyungHyun Cho, and Yoshua Bengio. Empirical evaluation of gated recurrent neural networks on sequence modeling. *arXiv preprint arXiv:1412.3555*, 2014. 7
- Jimmy Lei Ba, Jamie Ryan Kiros, and Geoffrey E Hinton. Layer normalization. *arXiv preprint arXiv:1607.06450*, 2016. 7, 13
- Razvan Pascanu, Tomas Mikolov, and Yoshua Bengio. On the difficulty of training recurrent neural networks. In *International conference on machine learning*, pages 1310–1318. Pmlr, 2013. 7, 12
- Jordan Hoffmann, Sebastian Borgeaud, Arthur Mensch, Elena Buchatskaya, Trevor Cai, Eliza Rutherford, Diego de Las Casas, Lisa Anne Hendricks, Johannes Welbl, Aidan Clark, et al. An empirical analysis of compute-optimal large language model training. *Advances in Neural Information Processing Systems*, 35:30016–30030, 2022a. 7
- Rahma Chaabouni, Eugene Kharitonov, Emmanuel Dupoux, and Marco Baroni. Anti-efficient encoding in emergent communication. *Advances in Neural Information Processing Systems*, 32, 2019. 8, 19, 20
- Fushan Li and Michael Bowling. Ease-of-teaching and language structure from emergent communication. In *Proc. of Advances in Neural Information Processing Systems (NeurIPS)*, 2019. 8, 20, 21

- Rahma Chaabouni, Florian Strub, Florent Alché, Eugene Tarassov, Corentin Tallec, Elnaz Davoodi, Kory Wallace Mathewson, Olivier Tieleman, Angeliki Lazaridou, and Bilal Piot. Emergent communication at scale. In *Proc. of International Conference on Learning Representations (ICLR)*, 2022. 8, 13, 17, 18, 19, 20, 21
- Mathieu Rita, Florian Strub, Jean-Bastien Grill, Olivier Pietquin, and Emmanuel Dupoux. On the role of population heterogeneity in emergent communication. In *Proc. of International Conference on Learning Representations (ICLR)*, 2022a. 8, 16, 19, 20
- Olivier Tieleman, Angeliki Lazaridou, Shibl Mourad, Charles Blundell, and Doina Precup. Shaping representations through communication: community size effect in artificial learning systems. *Visually Grounded Interaction and Language (ViGIL) Workshop*, 2019. 8, 19
- David Silver, Thomas Hubert, Julian Schrittwieser, Ioannis Antonoglou, Matthew Lai, Arthur Guez, Marc Lanctot, Laurent Sifre, Dhharshan Kumaran, Thore Graepel, et al. Mastering chess and shogi by self-play with a general reinforcement learning algorithm. *arXiv preprint arXiv:1712.01815*, 2017. 10
- Long Ouyang, Jeffrey Wu, Xu Jiang, Diogo Almeida, Carroll Wainwright, Pamela Mishkin, Chong Zhang, Sandhini Agarwal, Katarina Slama, Alex Ray, et al. Training language models to follow instructions with human feedback. *Advances in Neural Information Processing Systems*, 35:27730–27744, 2022. 10, 22
- Christopher M. Bishop. *Pattern Recognition and Machine Learning*. Springer-Verlag, Berlin, Heidelberg, 2006. 10, 12
- Ian Goodfellow, Yoshua Bengio, and Aaron Courville. *Deep learning*. MIT press, 2016. 10, 12
- Richard S Sutton and Andrew G Barto. *Reinforcement learning: An introduction*. MIT press, 2018. 10, 15
- David E Rumelhart, Geoffrey E Hinton, and Ronald J Williams. Learning representations by back-propagating errors. *nature*, 323(6088):533–536, 1986. 10
- Léon Bottou. Large-scale machine learning with stochastic gradient descent. In *Proceedings of COMPSTAT’2010: 19th International Conference on Computational Statistics Paris France, August 22-27, 2010 Keynote, Invited and Contributed Papers*, pages 177–186. Springer, 2010. 10
- Adam Paszke, Sam Gross, Francisco Massa, Adam Lerer, James Bradbury, Gregory Chanan, Trevor Killeen, Zeming Lin, Natalia Gimelshein, Luca Antiga, et al. Pytorch: An imperative style, high-performance deep learning library. *Advances in neural information processing systems*, 32, 2019. 10, 15
- Diederik P Kingma and Jimmy Ba. Adam: A method for stochastic optimization. *arXiv preprint arXiv:1412.6980*, 2014. 11, 18
- Simon Kirby. Spontaneous evolution of linguistic structure—an iterated learning model of the emergence of regularity and irregularity. *IEEE Transactions on Evolutionary Computation*, 5(2):102–110, 2001. 12, 20
- Mathieu Rita, Corentin Tallec, Paul Michel, Jean-Bastien Grill, Olivier Pietquin, Emmanuel Dupoux, and Florian Strub. Emergent communication: Generalization and overfitting in lewis games. *arXiv preprint arXiv:2209.15342*, 2022b. 12, 16, 17, 18, 19
- Ilya Loshchilov and Frank Hutter. Decoupled weight decay regularization. *arXiv preprint arXiv:1711.05101*, 2017. 12
- Nitish Srivastava, Geoffrey Hinton, Alex Krizhevsky, Ilya Sutskever, and Ruslan Salakhutdinov. Dropout: a simple way to prevent neural networks from overfitting. *The journal of machine learning research*, 15(1):1929–1958, 2014. 12

- Golnaz Ghiasi, Tsung-Yi Lin, and Quoc V Le. Dropblock: A regularization method for convolutional networks. *Advances in neural information processing systems*, 31, 2018. [12](#)
- Sergey Ioffe and Christian Szegedy. Batch normalization: Accelerating deep network training by reducing internal covariate shift. In *International conference on machine learning*, pages 448–456. pmlr, 2015. [13](#)
- Eugene Kharitonov, Rahma Chaabouni, Diane Bouchacourt, and Marco Baroni. Egg: a toolkit for research on emergence of language in games. *arXiv preprint arXiv:1907.00852*, 2019. [13](#)
- Eric Jang, Shixiang Gu, and Ben Poole. Categorical reparameterization with gumbel-softmax. *arXiv preprint arXiv:1611.01144*, 2016. [14](#)
- Chris J Maddison, Andriy Mnih, and Yee Whye Teh. The concrete distribution: A continuous relaxation of discrete random variables. *arXiv preprint arXiv:1611.00712*, 2016. [14](#)
- Diederik P Kingma and Max Welling. Auto-encoding variational bayes. *arXiv preprint arXiv:1312.6114*, 2013. [14](#)
- Richard S Sutton, David McAllester, Satinder Singh, and Yishay Mansour. Policy gradient methods for reinforcement learning with function approximation. *Advances in neural information processing systems*, 12, 1999. [15](#)
- Andreas Blume, Douglas V DeJong, Yong-Gwan Kim, and Geoffrey B Sprinkle. Experimental evidence on the evolution of meaning of messages in sender-receiver games. *The American Economic Review*, 88(5):1323–1340, 1998. [16](#)
- Angeliki Lazaridou, Alexander Peysakhovich, and Marco Baroni. Multi-agent cooperation and the emergence of (natural) language. *arXiv preprint arXiv:1612.07182*, 2016. [17](#), [20](#)
- Roberto Dessi, Eugene Kharitonov, and Baroni Marco. Interpretable agent communication from scratch (with a generic visual processor emerging on the side). *Advances in Neural Information Processing Systems*, 34:26937–26949, 2021. [17](#), [19](#)
- Jia Deng, Wei Dong, Richard Socher, Li-Jia Li, Kai Li, and Li Fei-Fei. Imagenet: A large-scale hierarchical image database. In *Proc. of Conference on Computer Vision and Pattern Recognition (CVPR)*, 2009. [17](#), [18](#)
- Olga Russakovsky, Jia Deng, Hao Su, Jonathan Krause, Sanjeev Satheesh, Sean Ma, Zhiheng Huang, Andrej Karpathy, Aditya Khosla, Michael Bernstein, et al. Imagenet large scale visual recognition challenge. *International journal of computer vision (IJCV)*, 115(3):211–252, 2015. [17](#), [18](#)
- Justin Johnson, Bharath Hariharan, Laurens Van Der Maaten, Li Fei-Fei, C Lawrence Zitnick, and Ross Girshick. Clevr: A diagnostic dataset for compositional language and elementary visual reasoning. In *Proceedings of the IEEE conference on computer vision and pattern recognition*, pages 2901–2910, 2017. [17](#)
- Ziwei Liu, Ping Luo, Xiaogang Wang, and Xiaoou Tang. Deep learning face attributes in the wild. In *Proc. of the International Conference on Computer Vision (ICCV)*, 2015. [18](#)
- Tadas Baltrušaitis, Chaitanya Ahuja, and Louis-Philippe Morency. Multimodal machine learning: A survey and taxonomy. *IEEE transactions on pattern analysis and machine intelligence*, 41(2): 423–443, 2018. [18](#)
- Vincent Dumoulin, Ethan Perez, Nathan Schucher, Florian Strub, Harm de Vries, Aaron Courville, and Yoshua Bengio. Feature-wise transformations. *Distill*, 3(7):e11, 2018. [18](#)
- Jiasen Lu, Dhruv Batra, Devi Parikh, and Stefan Lee. ViLbert: Pretraining task-agnostic visiolinguistic representations for vision-and-language tasks. *Advances in neural information processing systems*, 32, 2019. [18](#)

- Jean-Baptiste Alayrac, Jeff Donahue, Pauline Luc, Antoine Miech, Iain Barr, Yana Hasson, Karel Lenc, Arthur Mensch, Katherine Millican, Malcolm Reynolds, et al. Flamingo: a visual language model for few-shot learning. *Advances in Neural Information Processing Systems*, 35:23716–23736, 2022. 18
- Matthias Feurer and Frank Hutter. Hyperparameter optimization. *Automated machine learning: Methods, systems, challenges*, pages 3–33, 2019. 19
- Rahma Chaabouni, Eugene Kharitonov, Diane Bouchacourt, Emmanuel Dupoux, and Marco Baroni. Compositionality and generalization in emergent languages. *arXiv preprint arXiv:2004.09124*, 2020. 19, 20
- Yi Ren, Shangmin Guo, Matthieu Labeau, Shay B Cohen, and Simon Kirby. Compositional languages emerge in a neural iterated learning model. *arXiv preprint arXiv:2002.01365*, 2020. 19, 20
- Abhishek Das, Théophile Gervet, Joshua Romoff, Dhruv Batra, Devi Parikh, Mike Rabbat, and Joelle Pineau. Tarmac: Targeted multi-agent communication. In *International Conference on Machine Learning*, pages 1538–1546. PMLR, 2019. 19, 21
- Mathieu Rita, Rahma Chaabouni, and Emmanuel Dupoux. "lazimpa": Lazy and impatient neural agents learn to communicate efficiently. *arXiv preprint arXiv:2010.01878*, 2020. 19, 20, 21
- Katrina Evtimova, Andrew Drozdov, Douwe Kiela, and Kyunghyun Cho. Emergent communication in a multi-modal, multi-step referential game. *arXiv preprint arXiv:1705.10369*, 2017. 19, 21
- Diane Bouchacourt and Marco Baroni. How agents see things: On visual representations in an emergent language game. In *Proceedings of the 2018 Conference on Empirical Methods in Natural Language Processing*, pages 981–985, Brussels, Belgium, October–November 2018. Association for Computational Linguistics. doi: 10.18653/v1/D18-1119. URL <https://aclanthology.org/D18-1119>. 19, 20, 21
- Laura Graesser, Kyunghyun Cho, and Douwe Kiela. Emergent linguistic phenomena in multi-agent communication games. *arXiv preprint arXiv:1901.08706*, 2019. 19, 20, 21
- Valentin Taillandier, Dieuwke Hupkes, Benoît Sagot, Emmanuel Dupoux, and Paul Michel. Neural agents struggle to take turns in bidirectional emergent communication. In *The Eleventh International Conference on Learning Representations*, 2023. 19, 21
- Paul Michel, Mathieu Rita, Kory Wallace Mathewson, Olivier Tieleman, and Angeliki Lazaridou. Revisiting populations in multi-agent communication. *Under review*, 2023. 19, 20, 21
- Charles F Hockett. The origin of speech. *Scientific American*, 203(3):88–97, 1960. 20
- Henry Brighton and Simon Kirby. Understanding linguistic evolution by visualizing the emergence of topographic mappings. *Artificial life*, 12(2):229–242, 2006. 20, 21
- Jacob Andreas. Measuring compositionality in representation learning. *arXiv preprint arXiv:1902.07181*, 2019. 20
- George Kingsley Zipf. *The Principle of Least Effort*. New York, Hafner Publishing Company, 1949. 20, 21
- Terry Regier, Charles Kemp, and Paul Kay. Word meanings across languages support efficient communication. *The handbook of language emergence*, pages 237–263, 2015. 20
- Michael Clyne. Linguistic and sociolinguistic aspects of language contact, maintenance and loss. *Maintenance and loss of minority languages*, 1:17, 1992. 20

- Alison Wray and George W. Grace. The consequences of talking to strangers: Evolutionary corollaries of socio-cultural influences on linguistic form. *Lingua*, 117(3):543–578, 2007. ISSN 0024-3841. The Evolution of Language. 20
- Elliott Wagner. Communication and structured correlation. *Erkenntnis*, 71(3):377–393, 2009. 20
- Rick Dale Gary Lupyán. Language structure is partly determined by social structure. *PLoS ONE* 5, 1, 2010. 20
- Serhii Havrylov and Ivan Titov. Emergence of language with multi-agent games: Learning to communicate with sequences of symbols. *Advances in neural information processing systems*, 30, 2017. 20
- George Kingsley Zipf. *Human behavior and the principle of least effort: An introduction to human ecology*. Ravenio Books, 2016. 20
- Michael Cogswell, Jiasen Lu, Stefan Lee, Devi Parikh, and Dhruv Batra. Emergence of compositional language with deep generational transmission. *arXiv preprint arXiv:1904.09067*, 2019. 20
- Simon Kirby, Tom Griffiths, and Kenny Smith. Iterated learning and the evolution of language. *Current opinion in neurobiology*, 28:108–114, 2014. 20
- Steven T Piantadosi, Harry Tily, and Edward Gibson. Word lengths are optimized for efficient communication. *Proceedings of the National Academy of Sciences*, 108(9):3526–3529, 2011. 20, 21
- Jasmeen Kanwal, Kenny Smith, Jennifer Culbertson, and Simon Kirby. Zipf’s law of abbreviation and the principle of least effort: Language users optimise a miniature lexicon for efficient communication. *Cognition*, 165:45–52, 2017. 20, 21
- Irit Meir, Assaf Israel, Wendy Sandler, Carol A Padden, and Mark Aronoff. The influence of community on language structure: evidence from two young sign languages. *Linguistic Variation*, 12(2):247–291, 2012. 20
- Matthew S. Dryer and Martin Haspelmath, editors. *WALS Online*. Max Planck Institute for Evolutionary Anthropology, Leipzig, 2013. URL <https://wals.info/>. 20
- Florenca Reali, Nick Chater, and Morten H. Christiansen. Simpler grammar, larger vocabulary: How population size affects language. *Proc. of the Royal Society B: Biological Sciences*, 285(1871): 20172586, 2018. doi: 10.1098/rspb.2017.2586. 20
- Jooyeon Kim and Alice Oh. Emergent communication under varying sizes and connectivities. *Advances in Neural Information Processing Systems*, 34:17579–17591, 2021. 21
- Kalesha Bullard, Franziska Meier, Douwe Kiela, Joelle Pineau, and Jakob Foerster. Exploring zero-shot emergent communication in embodied multi-agent populations. *arXiv preprint arXiv:2010.15896*, 2020. 21
- Ryan Lowe, Abhinav Gupta, Jakob Foerster, Douwe Kiela, and Joelle Pineau. On the interaction between supervision and self-play in emergent communication. *arXiv preprint arXiv:2002.01093*, 2020. 21
- Lukas Galke, Yoav Ram, and Limor Raviv. Emergent communication for understanding human language evolution: What’s missing?, 2022. URL <https://arxiv.org/abs/2204.10590>. 21
- Cinjon Resnick, Abhinav Gupta, Jakob Foerster, Andrew M Dai, and Kyunghyun Cho. Capacity, bandwidth, and compositionality in emergent language learning. *arXiv preprint arXiv:1910.11424*, 2019. 21
- André Martinet. Elements of a functional syntax. *Word*, 16(1):1–10, 1960. 21
- Charles F Hockett. *A Leonard Bloomfield Anthology*. ERIC, 1970. 21

- Noam Chomsky and Morris Halle. *The sound pattern of English*. ERIC, 1968. 21
- Jerry A Fodor and Zenon W Pylyshyn. Connectionism and cognitive architecture: A critical analysis. *Cognition*, 28(1-2):3–71, 1988. 21
- Jan Rijkhoff. Word classes. *Language and linguistics compass*, 1(6):709–726, 2007. 21
- John Lyons. *Semantics: Volume 2*, volume 2. Cambridge university press, 1977. 21
- Shunyu Yao, Mo Yu, Yang Zhang, Karthik R Narasimhan, Joshua B Tenenbaum, and Chuang Gan. Linking emergent and natural languages via corpus transfer. *arXiv preprint arXiv:2203.13344*, 2022. 22
- Taylor Shin, Yasaman Razeghi, Robert L Logan IV, Eric Wallace, and Sameer Singh. Autoprompt: Eliciting knowledge from language models with automatically generated prompts. *arXiv preprint arXiv:2010.15980*, 2020. 22
- Mingkai Deng, Jianyu Wang, Cheng-Ping Hsieh, Yihan Wang, Han Guo, Tianmin Shu, Meng Song, Eric P Xing, and Zhiting Hu. Rlprompt: Optimizing discrete text prompts with reinforcement learning. *arXiv preprint arXiv:2205.12548*, 2022. 22
- Ruth-Ann Armstrong, John Hewitt, and Christopher Manning. Jampatoisnli: A jamaican patois natural language inference dataset. *arXiv preprint arXiv:2212.03419*, 2022. 22
- Yuchen Lu, Soumye Singhal, Florian Strub, Aaron Courville, and Olivier Pietquin. Countering language drift with seeded iterated learning. In *International Conference on Machine Learning*, pages 6437–6447. PMLR, 2020. 22
- Jordan Hoffmann, Sebastian Borgeaud, Arthur Mensch, Elena Buchatskaya, Trevor Cai, Eliza Rutherford, Diego de Las Casas, Lisa Anne Hendricks, Johannes Welbl, Aidan Clark, et al. Training compute-optimal large language models. *arXiv preprint arXiv:2203.15556*, 2022b. 22
- Hugo Touvron, Thibaut Lavril, Gautier Izacard, Xavier Martinet, Marie-Anne Lachaux, Timothée Lacroix, Baptiste Rozière, Naman Goyal, Eric Hambro, Faisal Azhar, et al. Llama: Open and efficient foundation language models. *arXiv preprint arXiv:2302.13971*, 2023. 22
- Yuntao Bai, Saurav Kadavath, Sandipan Kundu, Amanda Askell, Jackson Kernion, Andy Jones, Anna Chen, Anna Goldie, Azalia Mirhoseini, Cameron McKinnon, et al. Constitutional ai: Harmlessness from ai feedback. *arXiv preprint arXiv:2212.08073*, 2022. 22
- Marco Baroni, Roberto Dessì, and Angeliki Lazaridou. Emergent language-based coordination in deep multi-agent systems. In *Proceedings of the 2022 Conference on Empirical Methods in Natural Language Processing: Tutorial Abstracts*, pages 11–16, 2022. 22