

SECURITY FOR DISTRIBUTED WEB-APPLICATIONS VIA ASPECT-ORIENTED PROGRAMMING

NICOLAI KUNTZE, THOMAS RAUCH, AND ANDREAS U. SCHMIDT[†]

ABSTRACT. Identity Management is becoming more and more important in business systems as they are opened for third parties including trading partners, consumers and suppliers. This paper presents an approach securing a system without any knowledge of the system source code. The security module adds to the existing system authentication and authorisation based on aspect oriented programming and the liberty alliance framework, an upcoming industrie standard providing single sign on. In an initial training phase the module is adapted to the application which is to be secured. Moreover the use of hardware tokens and proactive computing is demonstrated. The high modularisation is achieved through use of AspectJ, a programming language extension of Java.

Key words and phrases. Identity Mangement, aspect oriented programming, single sign on, liberty alliance, proactive computing, aspectj, identity federation.

ACM Classification. K.6.5; D.1.5; D.2.

Address: Fraunhofer–Institute for Secure Information Technology SIT, Dolivostraße 15, 64293 Darmstadt, Germany.

Tel.: +49-6151-869-60227, *Fax:* +49-6151-869-704.

E-mail address: {Nicolai.Kuntze,Thomas.Rauch,Andreas.U.Schmidt}@sit.fraunhofer.de.

URL address: <http://www.math.uni-frankfurt.de/~aschmidt>.

[†]Corresponding author.

1. INTRODUCTION

Outsourcing of IT-infrastructure has become a common practise for companies and administrations. Pressure toward rationalisation has spurred desires to relocate central parts of business processes to external service providers. This becomes critical from a security viewpoint, in particular if employees of partner companies and field staff are to be given restricted yet direct access to a company's data stock within complex workflows [1, 2]. For instance, the Distributed Management Task Force has developed a comprehensive set of standards aiming at implementing security in distributed IT Systems, and Sun Microsystems has released a toolkit for Web-based Enterprise Management [3] based on them. However, to deploy security functionality for a total system based on an explicit security policy with this approach, a considerable effort has to be spent, in particular if legacy systems need to be incorporated [4]. Especially for small and medium-sized enterprises, this is not compatible with the pursuit of efficiency in, and through, IT-outsourcing.

We report on an approach, and its prototypical implementation, with which an existing web-application can be augmented by the three fundamental security functionalities authentication, authorisation, and accounting (AAA). Particular traits of the method presented are its universality, flexibility, and scalability. The conceptually new combination of common, freely available technologies with the paradigm of *aspect-oriented programming* [5] presupposes only a minimal knowledge of the system to be secured, and in particular its source code.

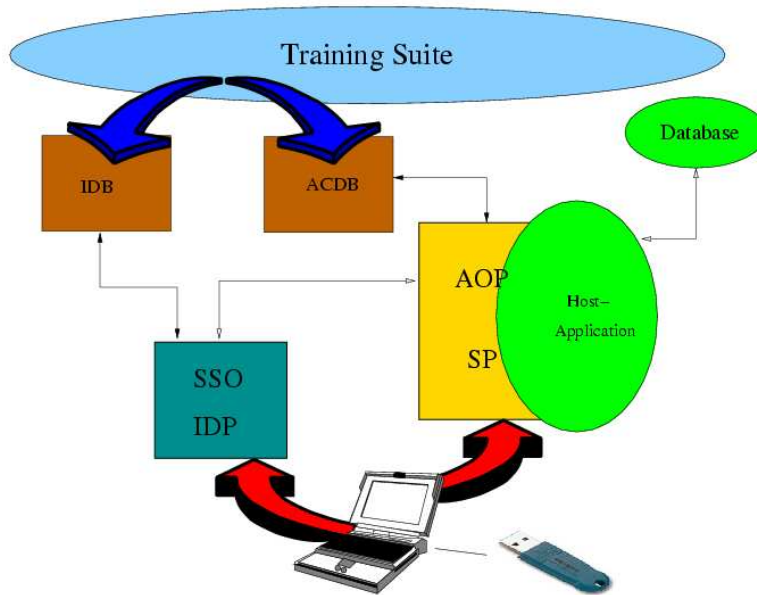

FIGURE 1. Aspect-oriented security architecture.

The sketch above shows the architecture. The application hosted by the service provider SP is joined at decisive points with a generic security module, the *security aspect* using the AspectJ framework, which thus gains control in all situations in which AAA functionality becomes necessary. The security aspect is the central interface to an identity management system, realised using the reference implementation SourceID of the Liberty protocol suite [6]. The latter single-sign-on (SSO) and accounting system of the identity-provider IDP exerts all tasks for authorisation and user management, providing the basis for the role-based access control system [7]. The RBAC model is implemented by the security aspect, which grants clients access to the application.

The data bases for accounting (IDB) and access control (ACDB) are built up by an intuitive method through an interactive process. The productivity phase of the system is preceded by a training phase during which all relevant workflows, i.e., sequences on web pages and contained entry masks, are learnt. Recorded state transitions in workflows are associated with authorised roles, allowing also for ancillary conditions, in particular states of the host application's data base. The security model follows the paradigm that only the recorded workflows are allowed and any other state transition is prohibited.

The security system is also flexible with respect to authentication methods. As an example, the combination of user-name/password authentication with authentication through ownership, here a hardware token [8], is demonstrated. The security system can be linked with arbitrary authentication methods, which in turn can be associated to roles in arbitrary combination. In particular, the usage of an intelligent hardware token enables proactive methods for security enhancement on the client's side, by guaranteeing freshness of the authentication by periodic polling for the token's presence.

The paper is structured so as to provide some background on the used methods first and then to detail the system's architecture, implementation and deployment. Readers mainly interested in the latter aspects might want to skip to Section 6. Section 2 gives an overview of the authentication system based on the Liberty Alliance Protocol. The proactivity Section 3 describes the usage of a hardware-token and the proactive component. Section 4 illustrates the usage of the Aspect Oriented Programming Language and the functioning of the security aspect. Section 5 goes into details about RBAC and the interdependencies between user, roles, and workflows. The architecture Section 6 describes the system architecture and the interaction of the system's modules. Chapter 7 provides a description of the prototypical implementation and gives an example for a typical deployment process. The conclusions discuss pros and cons of the present approach.

2. IDENTITY MANAGEMENT

Single sign-on (SSO) systems become more and more attractive in particular because they provide a way to ease the handling of multiple applications and accounts for users. In a closed infrastructure, SSO enables a centralised user management allowing or denying the user access to company resources. Different SSO systems, like Kerberos, have been developed over the last years.

Opening an IT-infrastructure toward the Internet creates new business concepts and therefore new requirements. In this context, an *identity* is a name with corresponding attributes. Web applications are performing on behalf of things with identities like computers, humans, or companies. Due to this, all Web applications have common requirements for security and related functionalities: authentication, authorisation, auditing, integrity, confidentiality, non-repudiation, and trust. Identity Management helps to implement these demands by *federation* of identities. In [9] five use cases for identity federation are identified. The **Internal Web Single Sign-On** covers log-on at the operating system. The second use case **External Web Single Sign-On** enables a user in company A to use resources of company B. The following use cases extend this core concept. **Attribute Exchange** enables company B to make a separate request for additional user attributes. By this, the user interaction can be personalised and thus become more convenient. Creation and deletion of accounts in remote security domains is described by **Federated Provisioning**. In the fifth use case, **Federated Web Services** are covered.

The Liberty Alliance [10], which represents a broad spectrum of associations and companies, tries to fulfil these demands through a set of protocols (see Figure 2) covering most aspects of federated identities, like opt-in account linking (a synonym for ID federation proper), simplified sign-on (SSO), basic session management, pseudonymity, and metadata (policy) exchange. The goal is to provide a common platform for federated user authentication systems. For instance, an airline and a car rental company can cooperate using ID-FF, providing the customer with combined offers and the possibility for only one login procedure for both

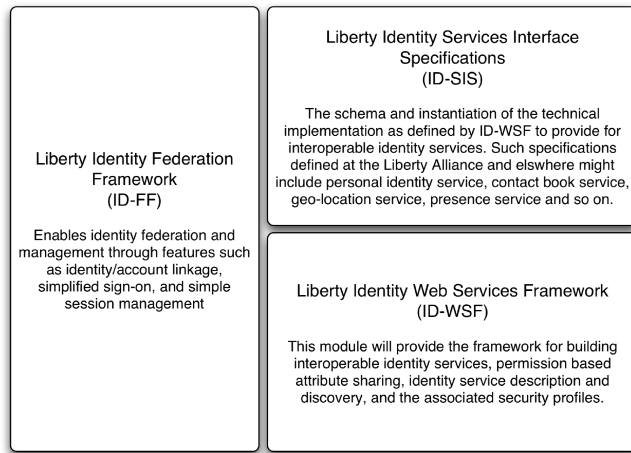

FIGURE 2. Liberty Alliance Architecture

companies' websites. A general disclaimer applies with respect to identity federation: Trust is more than a pure technical problem. Before federated identity networks can be established there must be working agreements defining the scope of a co-operation and commonly agreed policies.

The Liberty framework is based on the assumption that nearly all on-line applications are equipped with a user management system to which the user has to present his credentials upon login. ID-FF provides a way to reflect contractual relationships between different companies with respect to the login procedures of their different websites. Such an on-line relationship is called a Circle of Trust, see Figure 3, and contains an Identity Provider (IDP) and different Service Providers (SP). The IDP is the trusted central login portal which manages and authenticates users. The SP generally offers services to users who are in turn authenticated by the IDP on an SP's request. The cooperation of IDPs and SPs is not limited and static, different IDPs and SPs can be integrated on-the-fly.

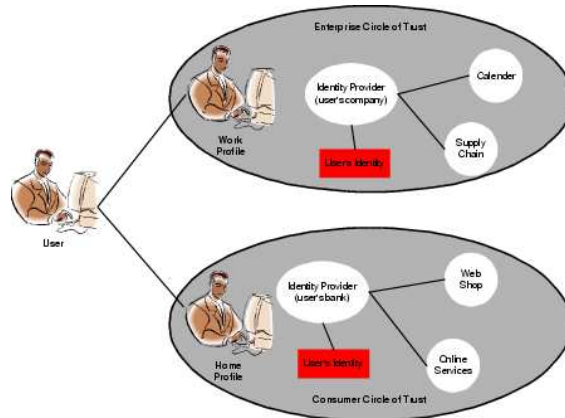

FIGURE 3. Circle of Trust

In our prototype, we enable the integration of the ID-FF protocol into an application without knowing and changing its source code. This is possible due to the fact that the security aspect encapsulates the complete application and integrates the service provider part of the ID-FF protocol by using the SourceID framework [11]. As we do not interfere with the internal execution of the host application only the ID-FF protocol is used in the prototype.

The AAA-Architecture is subdivided into the authentication part of the IDP and the authorisation and accounting part of the security aspect encapsulating the application. This presupposes a trust relationship between the SPs and the IDP which in turn is realised using the ID-FF protocol by exchanging granting tickets issued by the IDP. Authentication is in the domain of the IDP, audit and authorisation is located in the SP (see Section 6). Within this scenario it is possible to model security and implement special security and authentication methods, in particular hardware token based authentication, at the IDP. Furthermore administration is facilitated by the centralised accounting database (IDB).

At the moment there are big changes in the landscape of federated identity protocols. The Liberty Alliance has signed a Memo of Understanding with OASIS [12] in October 2004 and will extend their Inter-operable Testing Program to include SAML 2.0 [13]. It seems that Liberty, as a protocol, is largely drying up and the ID-FF 1.x protocol is the end of its standardisation life-cycle, in view of the fact that its functionality has been wrapped into SAML 2.0.

3. PROACTIVITY

Using federated identities in the context of the Internet needs (1) good authentication methods and (2) a user awareness about the value of their identity tokens. (1) is addressed by adding to the standard user name/password scheme an authentication by hardware token. Requirement (2) allows for various solution approaches. We chose to educate users by proactive methods.

During initial authentication, the user has to present his credential, user name and password. To check for a user's continued presence, periodical re-authentication is often used as an additional security measure. A periodical asking for the password is very bothersome and users tend to avoid such security measures. We use the USB hardware token Wibu-Key as authentication credential and re-authentication system. For authentication, a hardware-token based approach has the advantage that no user interaction is needed after the initial authentication and that the host system's identity is secured.

As a definition [14], a proactive system is

- 1) working on behalf of, or pro, the user, and
- 2) acting on their own initiative.

The applet is loaded into the users computer after login and checks if the hardware token is present and whether the user is working (keystroke and mouse-activity). If the user is inactive for a pre-defined period, the applet sends a message to the IDP and the user is automatically logged off. Thus, this applets assists the user if he forgets to unplug the hardware-token when leaving the workplace. The proactive applet is neutral with respect to authentication method and the criteria defining users' inactivity, and the re-authentication period is configurable. Needless to say, besides being a genuine security measure, this opens ways to protocol users' behaviour that may threaten their privacy.

4. ASPECT ORIENTED PROGRAMMING

In every object-oriented software design there are *core concerns*. For instance, in an robotic system these are motion management and path computation. These concerns are located in one class and are not needed in any other scope. Other concerns are common to many of a system's modules, like logging, authorisation, and persistence. These system-wide concerns are called *crosscutting concerns* in the aspect-oriented parlance and the reimplementations of one issue in different modules is called *code scattering*.

Starting in the year 1997 with [15] and [16] the paradigm of the aspect oriented programming (AOP) was developed. AOP attempts to isolate crosscutting concerns in special modules called aspects. According to [5], developing a system using AOP involves three steps: (1) Aspectual decomposition, (2) Concern implementation, and (3) Aspectual recomposition. In step (1) the crosscutting and core concerns are identified and separated. Step (2) comprises

the implementation and testing of each concern independently. Finally in step (3) recomposition rules are specified by creating aspects. The process of recomposition is referred to as *weaving*.

Weaving is the key feature of this programming paradigm. It uses weaving rules to define the point of execution of an aspect in the program flow. AOP distinguishes between where a concern has to be inserted into the program and when the concern has to be executed. The 'where' is defined by the *Pointcut* which is an identifiable point (join Point) in the execution of a program, e.g., a method call. The *Advice* is the aspect code to be executed. In the body of the Advice the execution time is defined by the keywords **before**, **after**, and **around**.

Weaving modifies the Java-bytecode. This means that it is possible to change a program's behaviour by adding features or removing them, even after the compilation process. The resulting program is native java bytecode without any need for a special runtime environment. In particular, all security checks performed by the java runtime environment (JRE) are left unharmed. Thus, the JRE still guarantees memory and type safety and restricts the usage of system resources.

The main achievement of AOP, as underlined in [17], is a better code comprehensibility due to the higher modularisation. Aspect-orientation also entails a higher re-usability of developed modules. Higher modularisation also means better verifiability of the single modules. On the negative side, it is often very difficult to verify the focus of the pointcut. Further research is needed to ensure that all intended methods are selected exclusively by them.

In general, authentication and authorisation are considered as good examples for AOP based implementations. In [5, chapter 10], a module using the Java Authentication and Authorisation Service (JAAS) is shown as example. In the simplest approach both concerns are executed before every execution of a method, checking the user authentication and the authorisation to use this particular method. This tends to slow down the application and thus the developer must carefully decide in which points to use the Pointcut destining the security checks.

AOP opens further possibilities for software development through 'Policy Enforcement'. Compile time declarations are used to formalise rules in the development of a system. For example a very simple rule can say that it is not allowed to use the **log** statement anymore.

The AOP methodology exists for different languages such as Java, .net and C++. Here we have used AspectJ (see [5]) as one of the oldest and best developed frameworks.

Using AOP instead of other technologies like wrappers [18] has the advantage of higher flexibility. Wrappers are less powerful in this respect, as AOP offers a higher modularisation. This is in particular helpful in implementing security as discussed in [19]. In [20] the different problems using container managed security are compared with a AOP based approach.

5. ROLE BASED ACCESS CONTROL

The core component of any security system is the *reference monitor* in which the security policy is defined. This means that the reference monitor mediates all accesses to *objects* (methods, database queries, service requests) by *subjects* (users, administrators, connected systems).

The present approach uses a modification of the Role Based Access Control (RBAC) model for the effective user rights. A user joins one or more roles and gets the combined access rights of the groups his or her roles belong to. A role describes an organisational work unit which changes only slowly over the time. The concept of a *workflow* is introduced to describe the steps involved in a single user task. In a Web-based system a step is the transition from one page generated by the Web-server to another. In this view, *Roles* are collections of allowed workflows describing the work which may be done by a user acting in this role. RBAC is a protection item centric ([21, p. 129], see also [22]) as opposed to a subject centric description of access rights.

Figure 4 shows the association between user, role, group, and workflows. This model en-

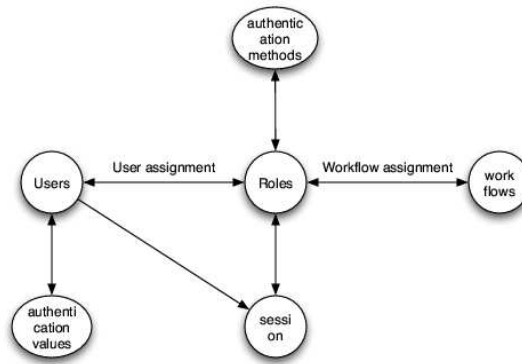

FIGURE 4. RBAC structure

ensures the possibility to define a security architecture following the rule of the least privilege as described by Schroeder and Saltzer [23]. The idea is that every subject only sees items he or she is allowed to see or use.

As formalised by R. Sandhu and S. Kandala in [24], workflows and the RBAC model can be used in combination. The access rights are interpreted as the right to execute a workflow and are called *explicit*. This means that the user obtains access rights through a finite state machine (FSM) computing the next step in the process. In this way the model grants *implicit* access rights which are changing over the time from page access to page access. In effect, the user moves inside the application on a predefined path. The realisation of workflows in a Web-based system needs a gentle way to react if the user tries (wilfully) to leave the path. Most graphical user interfaces have a common page the application is starting with. As a consequence every workflow contains at least this page as a common state in the FSM definition, and fall-back to this page is a commonly used method in case of access right violation attempts. It is also possible that two workflows have more than one page in common, which is also to be addressed by an RBAC implementation.

Tools used supporting the administrator in the definition of security rules must provide interfaces to define the RBAC model and the workflows.

6. ARCHITECTURE

Our security architecture encapsulates a Web-based system as shown in Figure 5. All incoming data is first processed by the **securityAspect** where the authentication and authorisation takes place. If the user is in at least one allowed workflow for his role the input is passed to the wrapped host system processing the resulting Web-pages as usual. These pages can also be passed through the **HTMLrewriter** where checks and modifications in the html code can be performed. Capturing the in- and output of the system is, in a Web-based

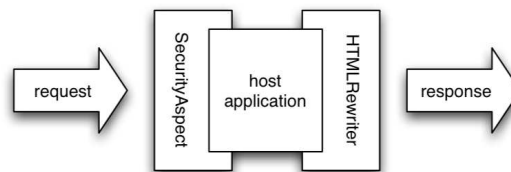

FIGURE 5. Encapsulation of the host system

application, easily implementable due to clear interfaces. Capturing all input means to wrap two interface methods: **get** and **post** (in the case of the Tomcat container). As every result of

the host system is a direct result of the request by the user, this is sufficient for authorisation control. It is also thinkable to wrap every method in the host system, thus enabling direct control over the its internal execution. It is then possible to exert extensive module testing, which can be useful for instance to test for buffer overflows or to find unusual patterns in the program execution. This line of thought, though interesting, was not further persecuted.

In Figure 6 the required modules are shown. Communication between them proceeds in vertical direction. The host application which is extended in its functionality is labelled green. The left block shows the software modules running on the client and the middle block represents the IDP modules. The hardware-token based authentication and proactive re-authentication is detailed in Section 3.

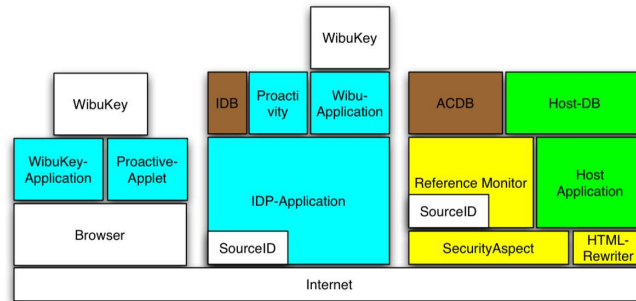

FIGURE 6. Modules of the aspect-oriented security architecture.

The important task of local application login, i.e., mapping of a user from the federated identity to an existing user known to the host system is, in the present approach, solved by calling the host application's login page from the securityAspect, and internally providing password and user name to it.

The reference monitor has no knowledge of the host application at all and decisions are made exclusively based on user input. Sometimes it is preferable to base a decision on the state of the host application, to implement for instance, a rule that can say that goods not in stock are not allowed to be sold. This problem is approached by accessing the host database (see below).

Due to the task separation between IDP and SP (see Section 2) two separate databases are required. The IDB stores all data authenticating a single user (such as passwords). The ACDB contains the descriptions of workflows, the RBAC model and consequently also the authentication methods required by the respective role descriptions. The dependencies are illustrated in Figure 4. Moreover the ACDB is used to store the states of the active workflows for every session. By this a user can have more than one active session. In such an extension, the user would for example be able to see different user records at the same time. If this side effect is not intended the Chinese Wall model [25] is an appropriate way to describe these exclusions without completely denying the usage of parallel sessions. By refinements of the present security model it is possible to define exclusive states or workflows implementing a variation of the Chinese wall model.

As mentioned above the administrator of the security rules needs tools for configuration of the securityAspect. This means support for the addition and specification of roles, users, workflows, and the connections between them. Handling users and roles is a quite common task. Generating workflows is much more sophisticated as the administrator has no knowledge of the system's source code. In view of this we chose a training based approach. Training means here that the actual system is used to define every required workflow by example. To this end, the host system is weaved with a special training aspect enabling the recording of user interaction. This aspect can be remotely controlled by a GUI which in particular starts and stops the recording. During recording every parameter returned by the Web-site

is shown to the trainer. The administrator can define admissibility rules for every parameter using regular expressions [26]. An advanced option is to define a SQL term describing a set including the value of the parameter (see Figure 8). As basically every response of a Web-application is based on a database state we believe that accessing the host database should solve most problems arising from the need to base access control decisions on internal states of the host system. The result of the training phase is a single XML-file containing all data required to construct the databases.

In the production phase, the host system is weaved with the securityAspect. At run-time, for every incoming request the securityAspect first checks if there was an initial authentication of the corresponding user and if re-authentication is required. In case an initial authentication is needed, it calls the liberty framework and the IDP to execute it. After authentication, the securityAspect calls the security reference monitor with all parameters of the request. The monitor then decides whether the request is allowed or not, by determining the actual active workflows and for every workflow its current state. It computes the set of successor states and whether they can be reached with the given parameters, taking into account the host database state. If the set of successor states is empty, the workflow is marked as 'not-active'. If all workflows are not active there is no following state und hence the access is denied and an error page is shown. From this error page the user can decide go back and retry using different parameters or go to a predefined page, which could, e.g., be the initial page of at least one workflow of his/her role. As stated above all workflows generically have a start page in common which is the page preferably used as base page in an error situation. After the host system has processed the input, it returns an HTML page to the client. Here, the HTMLrewriter rewrites the Web-page and integrates the applet which provides the proactive functionality.

As a side benefit, collecting audit data is easy in this model. Every action can be recorded and stored in a database in a personalised way. Actions are more than database accesses, in particular, every interaction with the host system can be logged, so it is in theory possible to recognise common flaws and mistakes in the user interaction or users with long idle times. Of course this may raise privacy concerns.

7. DEPLOYMENT SCENARIO

In this section we give a short overview of the deployment process of the prototypical implementation previously described.

Figure 7 shows a screen-shot of a workflow recording with the webtool, the main utility for the training phase. The recording has already been started and concurrently running the application the administrator is able to create a workflow description by simply clicking through it. As we are using a 'minimal need to know' security strategy [27] it is not necessary to define every possible exceptional state as every state not defined in the workflow is forbidden. Here, a gentle reaction of the security module is required supporting the user returning back into his workflow. The approach hides many complexities of, for instance, collaborative workflows involving more than one user. After saving the workflow it is possible



FIGURE 7. Workflow recording.

(see Figure 8) to edit the recorded workflows. In particular, one can change the parameters

of a submitted page in order to verify them in the production phase against a SQL database query or regular expressions.

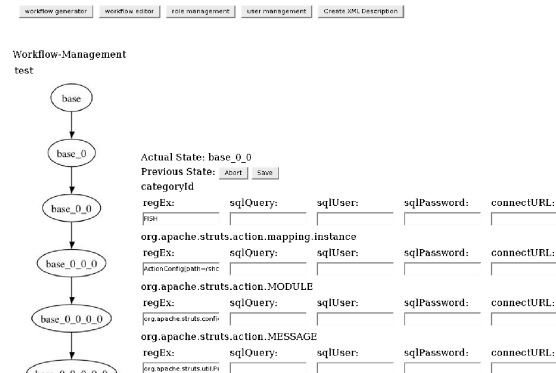

FIGURE 8. Workflow editor.

When all required workflows have been recorded, roles and users are created as shown in Figure 9. Every user has to be a member of at least one role and has to be assigned to one IDP. For the authentication by the IDP, every user gets a password and if he uses the Wibu-Key hardware token a Wibu-Key specific FirmCode and UserCode is assigned to identify the specific token. If the user is to be authenticated against the application user management system, the application specific user name and password must be provided, too.

The screenshot shows the 'User-Management' editor for 'user1'. It features a 'Roles' list with 'role1' selected. The 'IDP' section includes fields for 'Name of IDP' (jdp), 'Password on IDP' (test), 'SC-FirmCode' (j0), and 'SC-UserCode' (j3). The 'Application specific User and Password' section includes fields for 'User' (jee) and 'Password' (j2e4). 'Abort', 'Save', and 'Reset' buttons are at the bottom.

FIGURE 9. User editor.

At the beginning of the production phase, the securityAspect is weaved with the host application. With the HTMLRewriter aspect we changed the output of the application and added different debug messages and the applets for the Wibukey (see Figure 10). The green circle of the Wibukey applet shows that the Wibukey is attached to the PC and the user has shown activity in the observed period of time. If the hardware token is attached to the client without ongoing interaction, the light turns to red.

8. CONCLUSION

We have proved that it is possible to add AAA capabilities to an existing Web-based application without any knowledge of the source code of the host system. Furthermore we are able to 'plug-in' a workflow-based security policy which can be adapted in an intuitive way. By this we have also shown that aspect oriented programming is an appropriate tool for implementing security features into existing and new systems. It opens new possibilities in modularisation and code re-usage for system security.

An SSO enabled system offers a new quality in business interaction. Using the liberty framework it is possible to establish trust relationships with very little effort. In combination with workflows and the training suite, also small companies are enabled to interact with others and to establish Web-enabled workflows, e.g., for field personnel.

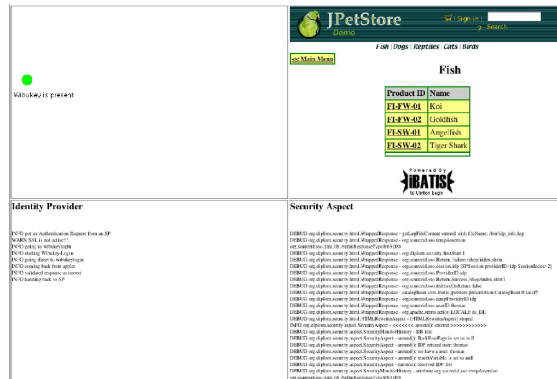

FIGURE 10. Productive phase

From a security perspective, the weak point of the present architecture is the single IDP. A denial-of-service attack can be used to make it impossible to use any service depending on the federated identity. This means that the IDP must be protected and that there is a need for a fall-back strategy. A second threat is a disclosure of the account data stored in the ACDB database.

Another problem lies in the high modularisation of security. As there is no direct connection between security and host system it is not possible to define rules allowing for consideration of internal states of the host system. We approached this issue by introducing SQL terms operating on the host database.

On the other hand a high modularisation means that it is possible to develop a ‘plug-in’ security module once and to reuse it in different products. This reduces costs and facilitates testing, thereby easing security evaluations. If there is a failure in the security module it is very easy to replace this part and to insert the optimised version into the system even at production time.

REFERENCES

- [1] Abdulwahed Mo. Khalfan. Information security considerations in IS/IT outsourcing projects: a descriptive case study of two sectors. *International Journal of Information Management* **24** (2004) 29–42.
- [2] Michael Mehrhoff. Outsourcing unter Sicherheitsaspekten. In: *D.A.CH Security 2004*, P.Horster (Ed.), syssec, 2004, pp. 62–70
- [3] Jeff Prorise. DMTF Web-Based Enterprise Management Initiative. URL: <http://www.dmtf.org/standards/wbem>
- [4] Michael Herfert, Andreas U. Schmidt, Peter Ochsenschläger, Jürgen Repp, Roland Rieke, Martin Schmucker, Steven Vettermann, Uwe Böttge, Cristina Escalera und Dirk Rüdiger. Implementierung von Security Policies in offenen Telekollaborationen. In: *D.A.CH Security 2004*, P.Horster (Ed.), syssec, 2004, pp. 37–49.
- [5] Ramnivas Laddad. *AspectJ in Action: Practical Aspect-Oriented Programming*. Manning Publications Co., 2003.
- [6] Liberty Alliance Project. Liberty Alliance Developer Tutorial. URL: http://www.projectliberty.org/resources/tutorial_draft.pdf.
- [7] D.F. Ferraiolo und D.R. Kuhn. Role Based Access Control. 15th National Computer Security Conference, 1992. URL: http://csrc.nist.gov/rbac/Role_Based_Access_Control-1992.html.
- [8] Wibukey Systems AG. WIBU-KEY. URL: <http://wibu.de/de/wibukey.php>.
- [9] Ping Identity Corporation Federated Identity Primer URL: www.pingidentity.com
- [10] Liberty Alliance URL: <http://project-liberty.org>.
- [11] SourceID - Open Source Federated Identity Management URL: <http://www.sourceid.org>.
- [12] Liberty Alliance Project Liberty Alliance Extends Liberty Interoperable Testing Program to Include SAML 2.0 OASIS Standard URL: https://www.projectliberty.org/press/details.php?item_id=111
- [13] OASIS OASIS Security Services URL: http://www.oasis-open.org/committees/tc_home.php?wg_abbrev=security#samlv20
- [14] Antti Salovaara and Antti Oulasvirta. Six modes of proactive resource management: a user-centric typology for proactive behaviors. *Proceedings of the third Nordic conference on Human-computer interaction*, ACM Press, 2004, pp. 57–60 URL: <http://doi.acm.org/10.1145/1028014.1028022>.

- [15] Gregor Kiczales, John Lamping, Anurag Mendhekar, Chris Maeda, Cristina Videira Lopes, Jean-Marc Longtier und John Irwin. Aspect-Oriented Programming. 1997.
URL: <http://www2.parc.com/csl/groups/sda/publications/papers/Kiczales-ECOOP97/>
- [16] Anurag Mendhekar, Gregor Kiczales und John Lamping. RG:A Case-Study for Aspect-Oriented Programming. 1997. URL: <http://www2.parc.com/csl/groups/sda/publications/papers/PARC-AOP-RG97/>
- [17] Bart De Win, Wouter Joosen und Frank Piessens. AOSD & Security: a practical assessment. February 28, 2003
URL: <http://www.cs.kuleuven.ac.be/cwis/research/distrinet/resources/publications/41067.pdf>
- [18] Thomas Bühren, Volker Gruhn und Dirk Peters. Konfigurierbare Sicherheit für Java Laufzeitumgebungen. D.A.CH Security, 2004, pages 329–340
- [19] Bart De Win, Wouter Joosen, and Frank Piessens. AOSD as an enabler for good enough security. URL: <http://www.cs.kuleuven.ac.be/cwis/research/distrinet/resources/publications/41066.pdf>
- [20] Pawel Slowikowski and Krzysztof Zielinski Comparison Study of Aspect-oriented and Container Managed Security In: AAOS2003: Analysis of Aspect Oriented Software, 2003.
- [21] C. Eckert. IT-Sicherheit. Oldenbourg Wissenschaftsverlag GmbH 2001
- [22] R. Sandhu. Role-based access control. In Advances in Computers, Vol. 46, pp. 237–286. M. Zelkowitz Eds. Academic, 1998
- [23] Jerome H. Saltzer und Michael D. Schroeder The Protection of Information in Computer Systems. 1975 URL: <http://web.mit.edu/Saltzer/www/publications/protection/>
- [24] Savith Kandala und Ravi Sandhu. Secure role-based workflow models. In: Proceedings of the fifteenth annual working conference on Database and application security, Kluwer Academic Publishers, 2002, pp. 45–58
- [25] D. F. C. Brewer und M. J. Nash The Chinese Wall Security Policy In: IEEE Symposium on Security and Privacy, 1989, pp. 206–214
- [26] Jeffrey E. F. Friedl. Mastering Regular Expressions. O'Reilly & Associates, Cambridge, MA, 1997
- [27] Fred B. Schneider. Least Privilege and More. j-IEEE-SEC-PRIV, 1(5):55–59, September/October 2003. URL: <http://csdl.computer.org/dl/mags/sp/2003/05/j5055.pdf>