ISOBUS— The Open Hard-Wired Network Standard for Tractor-Implement Communication, 1987-2020

Timo Oksanen and Hermann Auernhammer

Technical University of Munich, Germany

**For presentation at the
2021 Agricultural Equipment Technology Conference
Louisville, Kentucky, USA
8-10 February 2021**

**Published by the
American Society of
Agricultural and Biological Engineers
St. Joseph, Michigan, USA**

The Lecture Series has been developed
by the Machinery Systems Committee (MS-47) of ASABE to
provide in-depth design resource information for engineers in agricultural industry.
Topics shall be related to the power plant, power train, hydraulic system, and chassis components
such as operator environment, tires, and electrical equipment for agricultural or
industrial tractors or self-propelled agricultural equipment.

ASABE is grateful to Deere & Company for sponsoring the ASABE Distinguished Lecture Series.

Copyright © 2021
by the American Society of Agricultural and Biological Engineers

All Rights Reserved
Manufactured in the United States of America

This lecture may not be reproduced in whole or in part by any means
(with the exception of short quotes for the purpose of review)
without the permission of the publisher.

For information, contact:
ASABE, 2950 Niles Rd., St. Joseph, MI 49085-9659 USA
phone: 269-429-0300; e-mail: hq@asabe.org

ASABE is an educational and scientific organization dedicated to the advancement
of engineering applicable to agricultural, food, and biological systems.
For more information visit www.asabe.org.

ASABE Publication Number 913C0121
ASABE Distinguished Lecture Series,
Tractor Design No. 42

The American Society of Agricultural and Biological Engineers is not responsible for statements and
opinions advanced in its meetings or printed in its publications. They
represent the views of the individual to whom they are credited and
are not binding on the Society as a whole.

ISOBUS—The Open Hard-Wired Network Standard for Tractor-Implement Communication, 1987-2020

Timo Oksanen and Hermann Auernhammer

Technical University of Munich, Germany

Abstract. Several ideas of agricultural electronics were born in the 1980s when the first electronic systems were introduced to the control functions of a tractor as a rear hitch. During the 1990s, the trend was moving towards a mechatronic control of machinery but also towards informatics and data management. Both of these technological advances were requiring standardized communication interfaces for modular machinery systems to be used in farms around the world—tractor and implements. In this lecture, we go through the major milestones of ISOBUS, or the ISO 11783 standard series. In addition, the lecture presents the current state of the art of ISOBUS technology, both as the ISO standard but also the industrial aspects to develop products and deploy these in practice successfully to the market. We also discuss the future of the open ISOBUS over the next decades.

Keywords. Agricultural electronics, history, ISO 11783, ISOBUS.

Introduction

Electronics are nowadays an integral part of machinery within all sectors. This era of automation began in factories and plants, where the first steps were realized with mechanisms and mechanical automata. Later it was replaced with pneumatic logics and ultimately with electronics. While agricultural mechanization was one of the greatest achievements in the 1900s, the advances in electronics by means of transistors, computers and communication technology also brought a new era for agricultural machinery.

Electronics were first used in agriculture during the 1970s—even if the very first recorded application was DICKEY-John Seed Population Planter Monitor, already in year 1966. Typical applications in 1970s were standalone systems for planter monitors, combine harvester monitors, speeds sensors and moisture meters [1].

Electronics enabled an improved control of ventilation systems in barns for poultry and pigs with a faster and more precise reaction to different climatic situations. This was followed by concentrated feed on demand feeding for dairy cows using RFID animal identification systems. But all these first approaches were stand-alone systems without any connection to the farm management system and without the possibility of storing and processing data acquired via the new sensor technology.

The agricultural machinery business has limited resources to carry out extensive fundamental research programs to bring technology to a new level, compared e. g. to the worldwide automotive industry. Therefore, the agricultural machinery industry has in many cases followed the advances in neighboring industries and adapted technology simultaneously or somewhat later. Examples of the neighboring industries include passenger cars, trucks, earth moving machinery, other construction machinery and also marine vehicles. Technology following these examples include

the inventions such as the internal combustion engine, pneumatic rubber tires, diesel engine, hydraulics, pneumatically controlled brakes and the emission control, just to name a few. But all of these were included in closed systems, for instance a car, whereas for agriculture outside self-propelled units, any mechanization is an open system of different driving-units surrounded by one or more implements and all of them from different manufacturers. At that time only in a few countries worldwide, mechanization systems were offered and dominated in the manufacturer full-line applications.

While the automotive industry discussed and introduced its own bus systems, Robert Bosch GmbH developed the Controller Area Network (CAN), a universally applicable communication system. The project was started 1983 in Stuttgart by Uwe Kiencke, Wolfgang Borst, Wolfgang Botzenhard, Otto Karl, Helmut Schelling, and Jan Unruh [2]. The motivation was to provide a communication channel for more than two ECUs connected to the same “bus”—this originated from the Latin word omnibus, meaning “for all.” The bus technology allowed the simplification of the wire harness, instead of point-to-point cabling of all the connecting devices, it enabled the utilization of the same copper wires and the sharing of the physical media. The CAN bus was released in 1986. At that time, it was one of many new technologies or systems to realize bus systems—not the only one. During the late 1980s and early 1990s different incompatible technologies existed parallel. Around the year 2000, CAN bus became the dominating technology for vehicle communication and it has kept its place as the industry workhorse still today.

The CAN bus found its place in agricultural business relatively early, since 1987. Individual companies were interested in using the CAN bus as the internal communication bus in order to interconnect the dashboard and the engine of the tractor. CAN bus found also its way into implement monitors—to interconnect box in the implement and separate monitor in cabin—to multiplex signals that were previously hard wired.

In this lecture, we focus on the wired communication in tractor-implement system, which is commonly understood as the scope of ISOBUS. Other related functions and applications may refer to the wireless communication between machinery in the fleet, or to the cloud system. In this lecture, we do not discuss these extended features.







History of ISOBUS

The history of ISOBUS has two separate roots: roots from Germany with its neighboring countries and roots from North America. Introduction of electronics and computers happened worldwide in different industries and this resulted

in simultaneous advances in different regions to take industrial advantage of available components. The period of independent work towards bus-based tractor-implement in North America and Europe was quite short as it only can be counted from 1987 to 1989—after that a common group was formed under ISO—then the projects became aware of each other.

In order to understand the chain of historical events leading to the need for ISOBUS, we must go back to the years 1978-1987. For the first time, science was concerned with the electronic communication between the tractor and the implements [3,4]. In contrast, electronics had already arrived in practice, and it was already installed to some German and Danish machinery (Table 1).

Table 1: Process controllers in the 1980s.

Year	Controller	Services	Company	Layout**
1978	DOSITRON	First German electronics for crop protection sprayers with section control	Holder, Metzingen, Germany (id=15625)	 ?ID=15625
1983	MFC 5005	Multi-Functional Computer for implement monitoring and control	Müller Elektronik, Salzkotten, Germany	 ID=709066
1984	BORDINFORMATOR	On-board information device for CLAAS combine harvesters, later became CEBIS	Müller Elektronik, Salzkotten, Germany	 ?ID=14995
1987	UNI-Control	Universal mobile process computer for implement monitoring and control.	Müller Elektronik, Salzkotten, Germany*	 ?ID=716662
1987	Biotronic MAC	Universal mobile process computer for implement monitoring and control.	Biotronic GmbH, Staffelstein, Germany	 ?ID=709082
1987	LH Agro 5000	Universal mobile process computer for implement monitoring and control.	LH Technologies ApS, Aabybro, Denmark*	 ?ID=15266
1987	Multitron MC1	Universal mobile process computer for implement monitoring and control.	eh-electronics, Hannover, Germany	 ?ID=693796

* Both companies together sold European wide more than 100,000 units of this controller.
 ** Pictures in <http://mediatum.ub.tum.de/?id=nnnnnn>

With the exception of the BORDINFORMATOR, all of these technical solutions were aimed at monitoring and, above all, controlling attached equipment more precisely. But similar to fertilizer spreaders and sprayers, the speed information of the vehicle is required. For the manufacture of such an implement, the only option was to provide an inductive sensor kit with magnets, this was then installed by the farmer on the undriven front wheel of the tractor in order to get access to a near-real speed information. Then the question emerged, what if this signal was already available in the gearbox of the tractor—why would it be necessary to ask the farmer to install an additional speed sensor?

The need for a speed signal from the tractor to the implement was the main motivator to start development of a standardized communication. The first step was a connector that would provide a speed signal as analogue pulses to interconnect the pulse generator of the tractor to the pulse counter of the implement controller. A signal connector would thus become the ideal supplement to the already standardized power connector in DIN 9680 [5] in order to provide the implements with the required electrical energy and information.

Basic Tractor Signals and Power Supply for Implements

This standardization work began in (West) Germany as a working group for electrical interfaces at the LAV (Farm Machinery and Tractor Association—Germany), which was acting as a standardization group on behalf of DIN. The group was also consulting experts in the Netherlands, Denmark, France and Great Britain. This group started in the year 1986 under the leadership of Clemens Nienhaus and vice chairman Dr. Hermann Auernhammer.

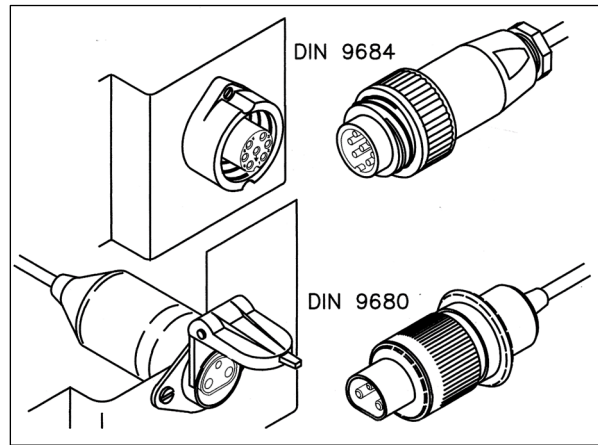

Figure 1: Power connector (DIN 9680, below) and signal connector (DIN 9684-1, above), <http://mediatum.ub.tum.de/?id=708642>.

DIN 9684-1 was published in 1988 as a draft standard [6]. This 7-pin connector contained both theoretical wheel speed and radar based ground speed, as well as the speed of PTO as pulses and the rear hitch work state as a binary signal. Thus, it complemented the already standardized power supply of the electronic implement control and also allowed the extension to the envisaged long-term solution. However, always under the premise of having to work with two connectors and two cables (Figure 1).

Later, this standard was progressed to ISO and the corresponding standard was to be ISO 11786. Originally, in DIN 9684-1 only five pins were used and two were left reserved for the future bus technology. However, in ISO 11786, these pins were taken for the use of proportional rear hitch level. This was included as a voltage signal and the 5 amp power supply pin to fill all 7-pins with functions (Figure 2).

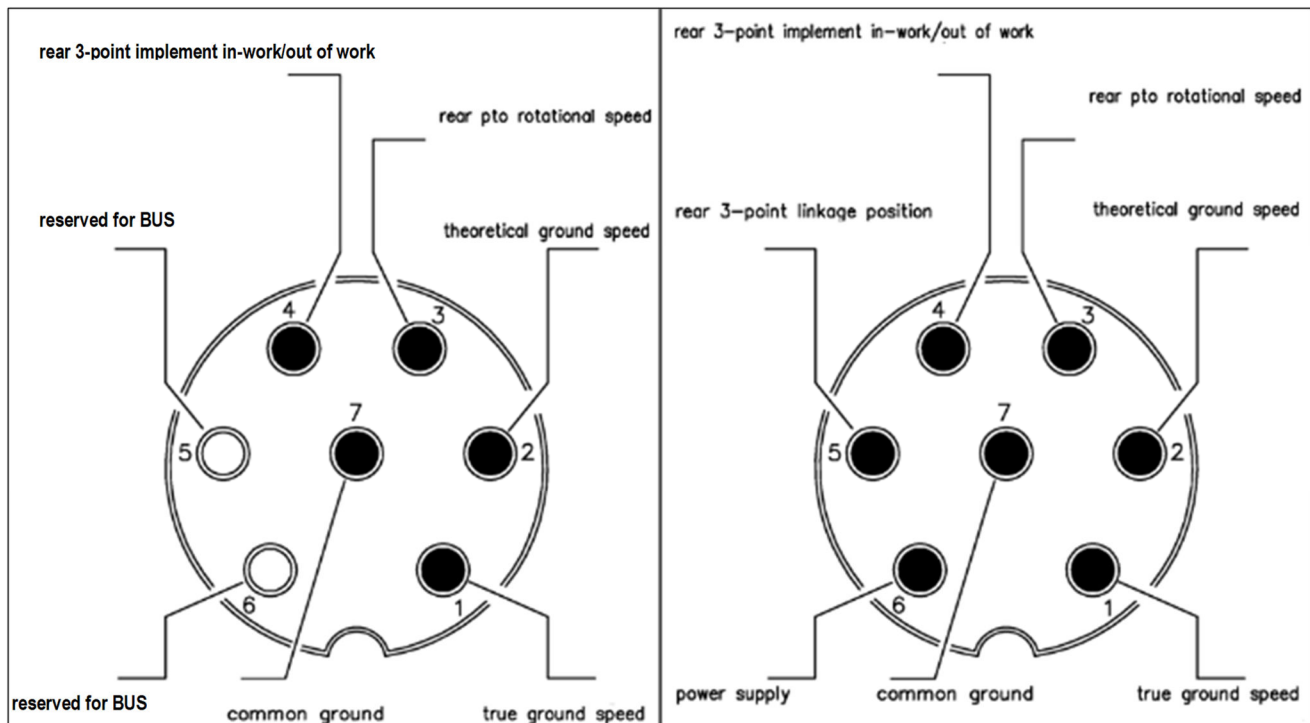

Figure 2: Signal connector in DIN 9684-1 (left) and ISO 11786 (right), <http://mediatum.ub.tum.de/?id=731284>, modified.

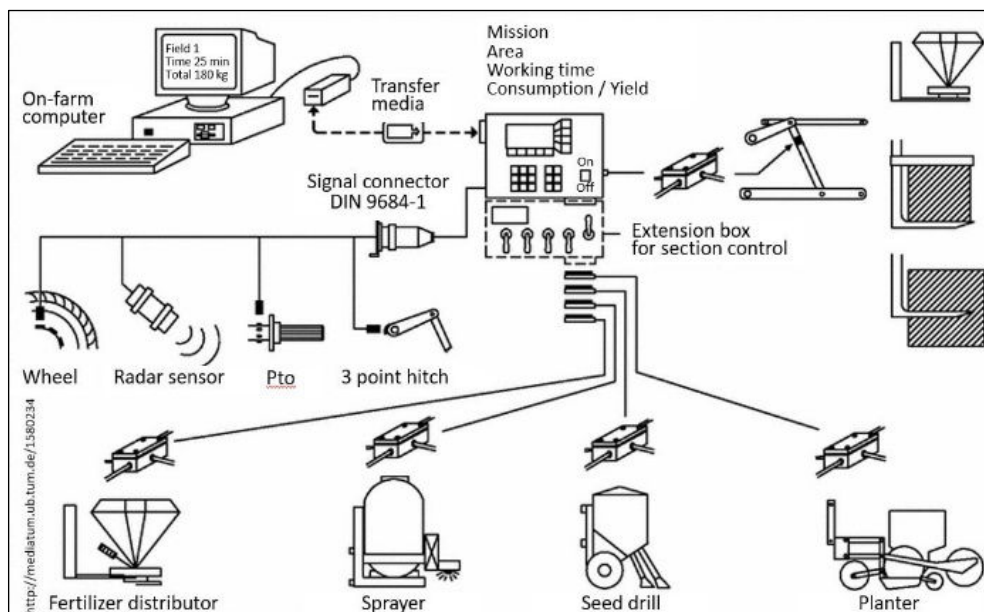

Figure 3: Applications of the mobile agricultural computer (centralized control, monitoring, closed-loop-control).

ISO 11786 compatible tractors were sold mainly in Germany and neighboring countries and enabled a prosperous market for the constantly growing electronic companies (see Table 1) with a wide range of their products for distribution and monitoring technologies (Figure 3). This is still available as an option for some tractor models, even if largely now replaced by ISO 11783.

It may be said that this analogue signal connector was the first real success story in the standardization of electronic communication between the tractor and the implement. A farmer could simply move the controller from tractor to tractor, always using the same user interface. Beneath it was the same operating philosophy hidden for each implement. There was the possibility of data transfer to the farm computer and in the case of problems, there was only one contact person responsible. However, the farmer became dependent on one electronics manufacturer and it was perhaps not possible to use the desired devices of certain other manufacturers if these were not compatible with the electronics supplier.

With thousands of installations, the success for DIN 9684-1 became the established framework of standardization across the agricultural machinery. Standardization of mechanical interfaces had already begun during the 1920s and different standardization organizations had experience in writing the standards, including ASAE, DIN, SAE. After the increase of globalization, many new standards were created under ISO over the next thirty years.

But nevertheless, it was already realized in 1987 that the afore mentioned DIN 9684-1 connector was not sufficient for future needs. Many small and medium-sized machines and equipment manufacturers recognized the new possibilities of electronics for their own products and became aware at the same time of their dependence on the few dominant electronics suppliers. In addition, new sensors for the yield measurement for combine harvesters (starting around 1985) and the possibility of weighing in attached distribution devices, as well as the aims to open GNSS navigation systems

for civil use (1983) opened new possibilities regarding precision farming.

From Point-to-Point to Bus

As the DIN 9684-1 signal connector offered only the one-way communication channel from the tractor to implement, it did not allow any further room for extensions unless populating more pins to the larger connector. The need for bus and multiplexing signals to the same wires was the obvious requirement for the second-generation tractor-implement communication standard. For realization, a task force was established under the LAV to define the requirements and to compile theoretical solutions available. Two original requirements were given from the machinery association to the group:

1. The tractor control system must be separated from the bus for implements to prevent external systems, not to endanger the safe use of the tractor itself. Therefore, the tractor was still seen as a signal provider, like a signal connector.

2. To avoid any extra cabling power, it was required that a supply voltage of external electronic units should be part of the new system.

The requirements in 1987 contained the following concepts:

- central control of tractor mounted implement from the driver's seat electronically,
- connection to the farm management computer for carrying out the orders,
- integration of tractor signals, and
- central entrance for diagnostics [7].

Historically, two milestone meetings were held in 1987 that shaped the future of ISOBUS. During the group meeting on 28 January 1987, the requirements for graphic display for the indication and bus terminal were written and the ad hoc group bus system was created. The second milestone meeting was 23 June 1987, which shaped the idea of graphical bus terminal, which was renamed two years later as virtual

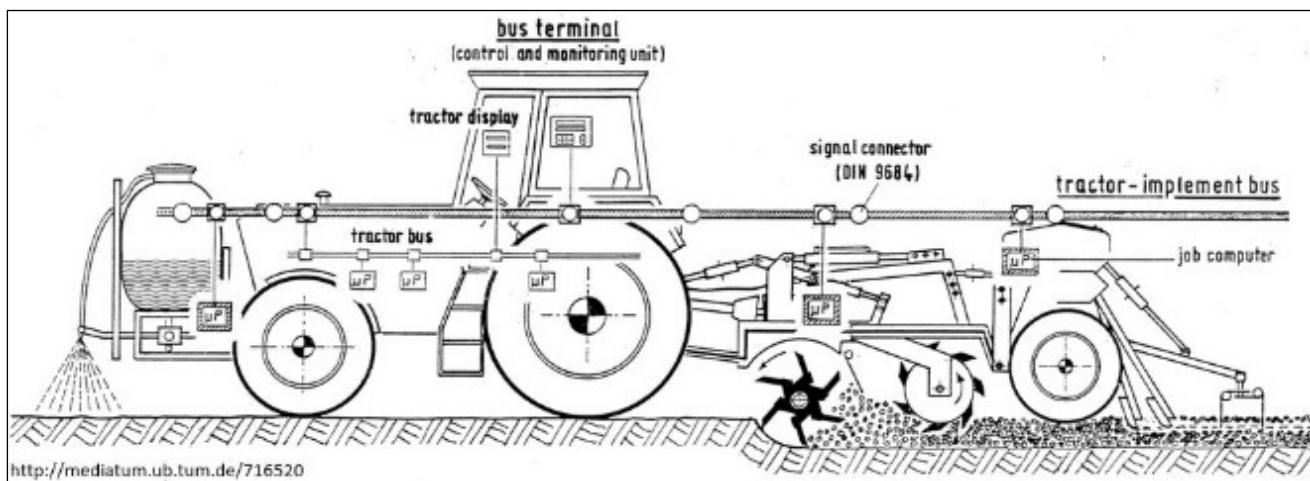

Figure 4: First LBS system layout June 1987 (created 1987-06-14 by Hermann Auernhammer).

terminal [7]. We consider 23 June 1987 as the birthday of LBS and therefore also the historical birthday of ISOBUS. The first visual design of LBS system was drawn in 1987— to the standardization meetings (see Figure 4).

The work from the German committee under the leadership of Dr. Hermann Auernhammer and supported by experts

from the industry and academia of the Netherlands, Denmark, France, and Great Britain, lead to DIN 9684 parts 2, 3 and 4 standards from 1987 to 1997 (Table 2). The common name for this technology was LBS (Landwirtschaftliches Bus-System) or Mobile Agricultural Bus-System [7].

Table 2: Milestones in LBS standardization.

Date	Decisions and Conclusions (LBS, 1993)
1987-06-23	First meeting of the LBS-Group; Tractor internal bus not part of the standard; Any device at the bus called an “implement;” No direct access to the on-farm computer
1987-09-29	General bus layout
1988-05-31	CAN bus (50 kBaud, 40 m with, original 11-bit ID, arbitration and 8-byte payload per frame); Working group “Identifier” established
1988-10-13	Report from working group “Identifier” (so called ROBRA-List), discussion LAV objection “User terminal must not be included in bus system”
1989-01-24	LAV agrees to work in the group and asks for speedy further processing; Report on exchange of experience with representatives of standardization bodies in the Netherlands, Great Britain, and Denmark
1989-03-16	Structure of the bus system in in Part 2: General, ISO reference model, 3: Protocol, 4: Identifier, 5: User interface, 6: Coupling to on-farm computer; Identifier reduction on minimum requirements; Proposal for Implementation of the standard in a pilot project
1989-06-20	Positive assessment of a pilot project “bus system” for the implementation of the standard at the BMELF, Bonn (29.5.1989), see Table 3. DLG will apply, tender for two systems with testing and practical demonstration at DLG; Identifier list adopted; Proposal for a virtual terminal
1989-11-10	Further discussions of the identifier list; bus design for max. 16 participants; Preparation of the first ISO meeting “Electronics”
1990-04-04	Report ISO session with reference to tightness of the system; Creation of working groups for protocol, identifier, data transfer and user interface; First executable proposal for physical interface
1990-11-17	For the identifiers, a partner system within devices suggested (LBS or own bus)
1991-09-12	Publication released for manuscript DIN 9684 Part 2—Serial bus system; Part 3—Initialization, Identifier; Part 4—User Interface
	Task Controller with “Task Input” and “Task Output” file formats were defined as DIN 9684 Part 5 including the data dictionary
1993-11-30	Presentation “Agricultural BUS system LBS (standardization and state of realization)” in a symposium within the framework of AGRITECHNICA 1993
1997-12-10	Publication released for manuscript DIN 9684 Part 5—ADIS Data dictionary; Baud rate extended to 125 kB; Part 2 to 5 adopted as DIN-draft standard
1998-01-19	Final meeting in Frankfurt; DIN 9684/1-5 defined [8]

Table 3: Milestones in the LBS pilot project.

Date	Actions and Contributions
1991-03-12	Basic discussion of the project with clarification of the tender according to content and specification sheet
1991-05-02	Legal examination completed; Tender of two systems after further additions in the specification sheet with determination of the dates: Publication: mid-June; Tender submission: 1991-08-03; Acceptance of bid: 1991-12-06; Prototype delivery: 1992-12-31
1991-10-29	Offer contents from LH-Agro & FENDT and MÜLLER Elektronik & John Deere analyzed; Contract decisions will be sent by mail on 1991-11-30 brought to shipping
1992-09-29	Receipt of the final company reports with discussion of open questions; Delivery dates of the prototypes to 2nd week of January 1993
1993-02-17	Plugfest in the DLG test center in Groß-Umstadt: Inspection of the prototypes including the voluntary one; Presentation of the experiences by the two companies involved and the voluntary solution from Biotronic & AMAZONE; Test equipment installed and functional; Pilot project finished

LBS Standardization Documents Become Reality





When the BMELF (Ministry of Food, Agriculture and Forestry), Bonn, promised its support for the implementation of the LBS standard under discussion on 29 May 1989, the activities of the group shifted to the pilot project at the DLG in Frankfurt under the leadership of Dr. Axel Munack (Table 3).

All LBS solutions presented at Plugfest delivered the requirements defined in the standard. However, the internal company agreements resulted in different layouts of the virtual terminal. This clearly showed the possible freedom in design and practical implementation (Table 4).

During the entire standardization period and beyond, a wide range of international LBS and ISO activities were carried out in addition to coordination with neighboring countries (Table 5).

As stated earlier, the main driving force at that time was the farmers use of the manufacturer independent technologies, on-farm data processing with automatic data acquisition and the visions of precision farming. Therefore, interconnection to farm management (PC) was a core requirement for the design of the system. LBS contained the idea of standardizing the information, but not the medium of how to

Table 4: Prototypes at the Plugfest in the LBS pilot project.

Contribution	Companies	Prototypes	Design *
LBS pilot project contract	LH-Agro & FENDT	Virtual Terminal, stand-alone in-cab device with extendable keyboard and extendable section control switches	 ?id=709433
LBS pilot project contract	MÜLLER Elektronik & John Deere tractor	Virtual Terminal UNI-Pilot, in-cab mounted	 ?id=708576
Voluntary	Biotronic & AMAZONE fertilizer distributor	Virtual Terminal Biotronic, in-cab mounted	 ?id=707847
LBS pilot project contract	DLG project-compliant connector	DIN 9684-1 connector with wired bus-lines pin 5 and pin 6	 ?id=708644
LBS pilot project contract and voluntary	DLG & FAL Braunschweig	LBS test equipment	 ?id=708649

* Pictures in <http://mediatum.ub.tum.de/?id=nnnnnn>

Table 5: Milestones of international activities related to the LBS and ISOBUS.

Date	Actions and Contributions
1989/09	First LBS presentation and publication at AGROTIQUE Montpellier, France (Ref: AGROTIQUE, 1989) [9]
1993/02	One-day discussion with US and CA ISOBUS representatives; presentation at the ASAE Winter Meeting in Nashville, USA (Ref: ASAE, 1993) [10,11]
1993/11	One-day LBS standard presentation AGRITECHNICA Frankfurt with bilingual publication (Ref: LBS, 1993)
1997/09	LBS presentation at B.R.A.I.N. and by the companies OMRON and YANMAR in Japan (Kota Motobayashi implemented LBS 1997 in Sapporo) [12]
2000/11	LBS program library is presented at the universities of Sapporo and Kyoto, Japan [13]

transfer the data between PC and the mobile system. Standardization of information meant that the Data dictionary was established to standardize process data. This concept is still alive.

LBS Moves to ISO

The initiation of the standardization under ISO was requested by Great Britain in 1988. Standardization work began under ISO Technical Committee TC23, Tractors, by a dedicated sub-committee SC 19, Agricultural Electronics. The Contributions and SC 19 started work under German chairmanship in 1991 and subsequently the working group WG1, Mobile electronics, was established. This group was responsible for delivering the ISO 11786 signal connector and all parts of ISO 11783, amongst other standards. The ISO TC23/SC19/WG1 remained unchanged from 1991 until 2020; the scope was redefined in 2020 when SC19 was restructured. During this period from 1991 to 2020, there were only three chairmen (convenors) for the working group WG1: 1991-1993 John Stafford; 1994-2011 Bob (Robert) Benneweis; and 2012-2020 Jaap (Jacob) van Bergeijk. Since 2020, SC19/WG1 is now responsible for the application layer of ISO 11783 and SC19/WG5 is responsible for the lower layers of ISO/OSI stack from ISO 11783.

After the unification of efforts to deliver a global solution for the tractor-implement bus system under ISO, the first challenges were to piece together experiences from organization members worldwide. ANSI (USA) was strongly favoring building the bus system on top of SAE J1939 standard (in 1994, first J1939 docs #11, #21, #31 were released,) which was developed simultaneously for on-road truck vehicles under SAE (Society of Automotive Engineers). Also, the American tractor industry was in favor to base the new ISO standard on J1939, instead of 11-bit LBS.

Luckily, SAE J1939 standard series was also based on CAN bus, so it was important to find a good compromise in the changes and derive requirements for the new ISO bus system from common needs. At the time of WG1 establishment, Robert Bosch GmbH had already published the version 2.0 of the specification, which offered more degrees of freedom, including extended 29-bit identifiers. The decision whether to go for 11-bit or 29-bit identifiers is one of the rare cases when WG1 has had to vote.

The decision was made in the 2nd meeting in Cologne (Germany) on 25 February 1992. Five representatives from Canada, Denmark, Germany, the Netherlands, and the USA resulted in a deadlock situation between Denmark and the Netherlands for 11-bit versus Canada and the USA for 29-bit. Auernhammer was representing Germany. It was decided after a short interruption to the dissatisfaction of the European participants that the 29-bit and CAN 2.0b (29-bit ID) should be adopted. This also led to the decision to harmonize lower layers of the protocol with SAE J1939 protocol stack. WG1 designed the protocol to follow ISO/OSI model and respectively OSI layers 2-4 were harmonized and are still harmonized until today. However, the functional concepts for application layer (virtual terminal, task controller) and data dictionary were derived from German DIN 9684 based LBS. This was a compromise and the benefits of preceding fundamental standardization work and experience on both shores of Atlantic Ocean. SAE J1939 provided a particularly good base for addressing procedures as well as diagnostics, while DIN provided concepts for functionalities in agricultural domain.

Work towards ISO 11783 started in 1991. In parallel, work towards DIN 9684 continued with LBS products on the market from FENDT, Massey Ferguson, AMAZONE and Pöttinger, as there was an uncertainty of how fast it would be possible to make an international ISO standard and, finally, to create pressure on the ISO work [14].

ISO standardization continued in the first half decade of 1990, under the leadership of Bob Benneweis (FlexiCoil / CNH) and the dedicated support from Dr. Marvin Stone (Oklahoma State University). During the last half decade of 1990, it was focused on building the base for the whole standard series with fruitful leading contributions from William Formwalt and Terry Picket (John Deere), Rudolf "Rudi" Buschmeier (Müller Elektronik) and Dr. Hermann Auernhammer (TUM) from Germany, Dave Sokol (Vansco Electronics) from Canada and with Dr. Daan Goense (Wageningen University) from the Netherlands (Figure 5). The group consisted of experts both in industry and academia, in two continents.

The work of the ISO 11783 series continued during the whole of the 1990s and ultimately into the year 2000, the first drafts of ISO 11783 were ready for making prototypes. The first editions of the International Standard were published in 1998 (Part 3), 2001 (Part 4, 5 & 9), 2002 (Part 2 & 7) and 2004 (Part 6). Today, these parts have been revised a couple of times and these stages are typically available in the 3rd or 4th edition.

In addition to these activities, efforts were made to involve the industry and farmers in the ongoing standardization process and to achieve the first practical implementations. Still, in the memory of many visitors of the AGRITECHNICA 2001 (Hannover, Germany) are the symbolic wooden tractors with the yellow ISOBUS cable connections around the fair ground. They were intended to familiarize visitors with the emerging standard and at the same time to highlight those manufacturers who were able to show the first implementations (Figure 6).

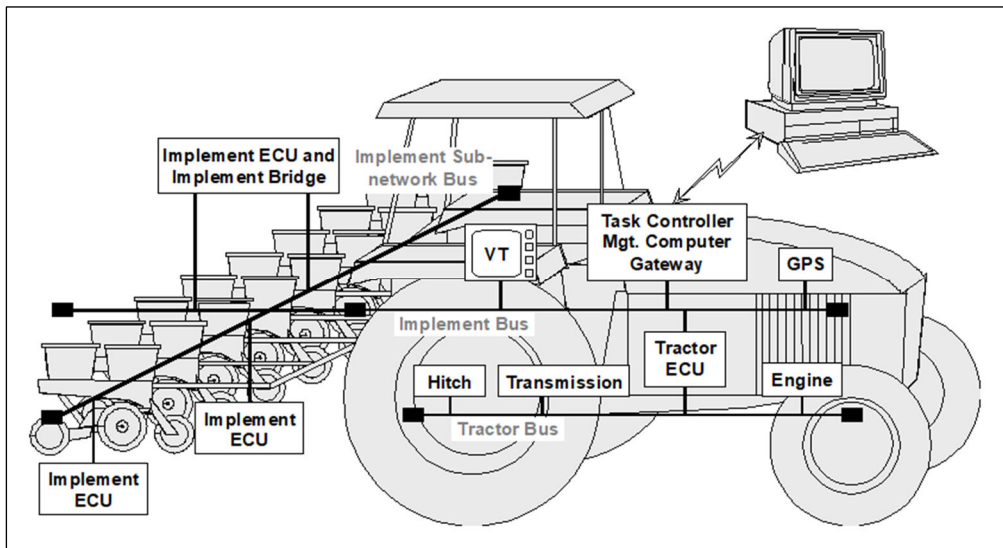

Figure 5: ISO 11783 layout, by Marvin Stone et al., 1999 [15].



Figure 6: The very first time ISOBUS was presented at AGRITECHNICA exhibition November 2001 in Hannover (Germany). Photo: Kota Motobayashi.



Figure 7: The ISOBUS Model Tractor from the Technical University of Munich, presented at AGRITECHNICA exhibition 2003 in Hannover (Germany). Photo: Kota Motobayashi.

Also, the ISOBUS model tractor created with the ISO-BUS library from Achim Spangler [16] and fully equipped with sensors and actuators to show the ISOBUS in a precision farming environment still is in mind of visitors. This configuration is still used today in the training of students and opens first contacts and experiences in practical ISO-BUS application (Figure 7).

It can be said that after this event, former LBS bus system was replaced by the ISO bus system—or shortly ISO-BUS.

Implementation Groups on Both Sides of the Atlantic Ocean

Standards aim at providing agreements about technical details, but in general there are a few reasons why a written standard is not sufficient alone. When the standard has been written and published, the intention is that companies follow the standard in their product development and ultimately the components work together as intended. It may be possible to write a standard for simple mechanical couplings, like PTO shaft, that does not allow any room for interpretation, but in such a complex communication standard as ISO 11783, there is always room for interpretation at various levels even if experts have tried their best when writing it. A simple mechanical interface is also rather easy to verify using caliper by anyone whether it follows a standard or not, but communication standard cannot be verified without special tools.

Due to these reasons, around year 2000, the companies realized that they need another body to resolve conflicts of interpretation and to measure compatibility of components made according to the standard. While members of ISO are nations represented by their national standardization organizations (e.g. DIN for Germany, ANSI for USA), the common interpretation group was formed as a joint group of companies directly—with no national organizations in between. One implementation group was formed to Germany, called

Implementation Group Isobus (IGI) and another to USA called North America Isobus Implementation Task Force (NAITF). Both implementation groups were suborganizations of pre-existing regional machinery manufacturer organizations, VDMA and AEM respectively.

For common interpretation of ISO 11783 standard, Implementation Group defined additional documents on top of standard that defined better how the different details of the standard series should be engineered. These additional documents defined which versions of each standard should be used together (sometimes even DIS drafts of standards included to the set) and also clarified what is mandatory and what is optional. Particularly, for Part 10 ISO-XML, the implementation group defined a subset, to clarify what is the minimum set of objects that every manufacturer has to support in order to be compliant, by defining a few advanced elements as optional plus defining minimum or maximum number of elements that a device/software has to be able to support. Implementation group members were bringing on table issues found in the field by their customers and step by step the implementation levels improved compatibility. The documents were known as Implementation Levels (IL) and the last Implementation Level was four, before AEF redefined the concept to be better visible to farmers (AEF functionalities will be discussed later).

AEF Injects Momentum into ISOBUS Standardization

A remarkable milestone in the industrial adaptation of ISOBUS was in October 2008, when Agricultural Industry Electronics Foundation, AEF, was founded (registered in Germany as e.V.). AEF was founded by seven big agricultural machinery companies (AGCO GmbH, Alois Pöttinger Maschinenfabrik, CLAAS KG, CNH Österreich GmbH, Deere & Company, Grimme Landmaschinen GmbH, Kverneland Mechatronics) as founding members. Nowadays, there are eight core members, most of which are still the same but with a few changes. AEF has two levels of membership. Core members form the steering committee that makes the ultimate decisions what are the directions—and only core members have the rights to vote officers. General members have access to various documentation and membership is required to certify any component in practice. The ratio of membership fee of core members and general members is roughly 25:1. The structure of the organization follows other industry driven consortiums (e.g., AutoSAR) where members are divided into core, inner circle, and outer circle.

As written earlier, prior to AEF, the implementation of ISO 11783 was divided between Europe and North America. Both continents had their own implementation groups or task forces, to make common industrial interpretation of the standard series. Implementation levels 3 and 4 were the last valid versions. The main difference to current AEF functionalities is that, Implementation Levels covered all components as system level versioning (including Virtual Terminal, Task Controller, Tractor ECU, File Server, Diagnostics,

FMIS etc.), while AEF functionalities provide generations from component type.

Prior to AEF, the compatibility tests of ISOBUS components were carried out only by DLG in Germany—in practice. DLG provided test results and ISOBUS compatible products received a yellow sticker label as a proof of conformance. These were important signs of compliant products in the era from 2003 to 2012. This was the only signal for farmers to know which products were qualified.

One of the motivations to establish AEF was related to testing. Prior to AEF, component tests were carried out mostly by manual operation, by a test engineer. The test engineer completed the work with a high quality, but manual work is slow and therefore the passthrough was limited. Automated testing procedures for components were desired. AEF has invested on defining clear test requirements and associated automated tooling. However, the tools are operated by a few audited independent test laboratories around the world—AEF does not carry out conformance tests. AEF prepares requirements and creates the test tool with subcontractors.

Another motivation to establish AEF was related to finances. Prior to AEF, both standardization work and efforts to define implementation were based on goodwill of regional industry and this delayed bringing the ideas to reality—such as automated testing of components. Since the establishment, AEF has collected membership fees and those are used to cover costs of test tool development, databases for diagnostic purposes and to promote ISOBUS worldwide. However, all the technical experts work in different project groups free of charge, representing their companies—as a part of their daily work, and certain goodwill.

ISOBUS Today

Presently, ISO 11783 standard series contains 14 parts. The summary of the current status and properties of each Part is shown in Table 6. In addition to printed standards, a remarkable part of coding data is now available at isobus.net online database, which is frequently updated. For instance, the majority of coding data that was included in the original prints of Part 1 and Part 11 are now currently only available from the online database.

In addition to the aforementioned standards, they contain also normative references to other standards, for example ISO 11898, which defines fundamentals of the CAN bus.

During the early 2000s, it was sufficient to acquire ISO 11783, a standard series, and then implement hardware and software according to those rules. As for prior to 2010, there were very few numbers of additional test requirements or exceptions to the printed standard. Today, in order to conform to ISOBUS, various documents need to be prepared by the AEF. These documents are in alignment with the ISO 11783 standard series document from actual tests and they define exceptions to the standard documents. Most of the exceptions are small but remarkable, e.g., minimum number of sections may be remarkably different in ISO 11783 than in the conform specifications. AEF guidelines also provide additional implementation notes that guide manufacturers to make similar interpretation of the standard.

Table 6. ISO 11783 standard series

Part	Title	Current Edition	#Pages	Notes
1	General standard for mobile data communication	2017 (Ed. 2)	19	
2	Physical layer	2019 (Ed. 3)	66	Harmonized with J1939
3	Data link layer	2018 (Ed. 4)	62	Harmonized with J1939
4	Network layer	2011 (Ed. 2)	32	Harmonized with J1939
5	Network management	2019 (Ed. 3)	30	
6	Virtual terminal	2018 (Ed. 4)	348	
7	Implement messages application layer	2015 (Ed. 3) + AMD 2018	185 + 32	
8	Power train messages	2008 (Ed. 2)	3	Only references to J1939
9	Tractor ECU	2012 (Ed. 2)	17	
10	Task controller and management	2015 (Ed. 2)	205	
11	Mobile data element dictionary	2011 (Ed. 2)	3	Only references to other documents
12	Diagnostics services	2019 (Ed. 3)	31	Harmonized with J1939
13	File server	2011 (Ed. 2)	46	
14	Sequence control	2013 (Ed. 1)	65	

Functionalities and Generations

As written above, the standard and different versions of that are difficult to understand for end users, which in this case are usually farmers. Compatibility of products requires that two companies have made products based on the same standard editions and with the same clarifications defined by implementation group (which earlier was called Implementation Levels). For instance, if some component was made according to the Implementation Level 4, it could be assumed that it is only compatible with other components at the same level—even if the situation would be better in practice.

AEF decided to move away from Implementation Levels which were for the whole system and replace that with so called Functionalities and their generations, starting in the year 2010. This new era brought also a new term, Universal Terminal (UT), which is not known by the ISO 11783 standard series at all. Universal Terminal is a brand name for Virtual Terminal (VT)—a better name was selected for marketing reasons. The first generation was UT 1.0; the numbering scheme was taken from the computer world—USB 1.0 and 2.0 were standards at that time. Most of other Functionality names and acronyms were taken directly from the standard, like TC and TECU, but some other new ones were defined by the marketing group, including AUX referring to auxiliary inputs or TC-GEO and TC-SC referring to full version TC and section control.

Guidelines

Another change from the former Implementation Levels to AEF organization was the introduction of Guidelines. Guidelines are also split based on Functionalities, but also, other kinds of Guidelines have been released as clarifications to ISO 11783 standard series.

Still, the most relevant for ISOBUS engineers are the guidelines that give instructions to read ISO 11783 standard correctly, with corrections and exceptions. Some of the exceptions introduced in the very first guidelines are now included in the latest editions of ISO 11783 standards, so

guidelines also can be considered as patches that fix loop-holes in the standard more rapidly than the standard update cycle allows.

In addition, AEF has made guidelines for high voltage interface, extended farm management information systems data interface (EFDI), analogue camera interface and labeling various ISOBUS functionalities in the products. Aforementioned guidelines are examples of new norms that are developed by AEF and later to be transferred to ISO standardization.

Plugfest

The concept of a “plugfest” refers to events where a product or prototype and their engineers convene in a single location to test the compatibility in practice. While similar concepts have been existing in other industries, the very first bus related plugfest was organized in Gross-Umstadt in 1993, to place together LBS prototypes made by different companies. This was a part of a German research project and was realized on 30 November 1993 in Frankfurt, next to the AGRITECHNICA ‘93 activities, with four companies testing their prototypes.

The first ISO 11783 related plugfest was organized in Wageningen, Netherlands in the year 2001, with fifteen people. In earlier years, some special plugfests have also been organized for complete machinery, but the common format contains only ECU’s of these machines, in order to fly with engineers around the world. It was proposed in 2002 that a pattern of organizing one annual worldwide ISOBUS plugfest in North America during spring, and another annual worldwide ISOBUS plugfest in Europe during fall has become the tradition until today. In practice, companies selling products globally attend the plugfest twice a year to test compatibility, while regionally operating manufacturers usually only attend the plugfest in their own continent. Today, plugfests are a three-day convention of around 200 ISOBUS engineers and 100 ISOBUS devices per event (Figure 8).

In practice, the participating company with an ECU product/prototype has a dedicated time slot for each counterpart to test whether the combination works fine. This allows en-

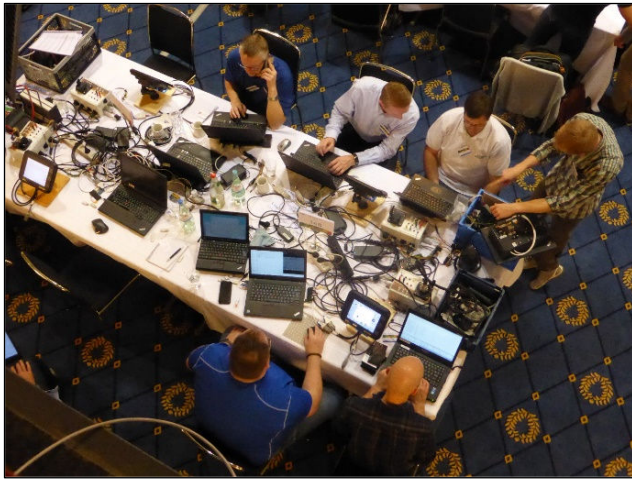

Figure 8. Typical set up in the plugfest when terminal and implement are tested together—engineers, laptops, cables, and adapters are needed in addition to electronic control units. Each combination has about 20-30 minutes to test how well the system works together. Photo from AEF Plugfest 2017 in Stuttgart.

engineers to see how their product is accepted by the counterpart, but also how it looks and behaves, which is sometimes measured subjectively. The test results from the plugfests do not have any official value and that is not the purpose. Today, one benefit of the plugfests is that it allows the newcomers to the market to get valuable feedback on their product development. Plugfests are also beneficial for the established companies to test their new software generations, which are not yet released for farmers. For the community of ISOBUS standardization experts, the plugfest have revealed loop holes in the standard series—if a sentence of the standard can be interpreted in two different ways and both ways are in conflict with the standard, the standard has to be improved.

Plugfests should not be mixed with demonstrations. Plugfests are closed events where engineers of components can test their ISOBUS prototypes without pressure of farmers or journalists. Demonstrations of the ISOBUS (and LBS before that) have been presented in various venues, and the Agritechnica exhibitions in Germany have been a target for demonstrations many times. The very first time the ISOBUS was demonstrated to farmers and other exhibition visitors was in Hannover during November 2001. Since the establishment of AEF, it has had its own booth in Agritechnica and other remarkable agricultural machinery exhibitions in different regions, to promote the ISOBUS compatibility, but also to demonstrate the latest achievements in standardization of technologies beyond ISOBUS—like high voltage interface or farm data connectivity. A tradition of publishing standardization achievements to a large audience in the Agritechnica exhibition seems to continue also in the future—this is done a bit earlier than products supporting these new updates are released.

Conformance Test

The need for ISOBUS component testing to validate conformance to the standard was realized around year 2000. At the ISO WG1 meeting in 2002, Dr. Daan Goense

(Wageningen University) and Mr. Reinhard Hübner (DLG, Germany) [17] proposed a concept of testing procedures that consists of three elements: 1) the plugfests, 2) a software package to perform self-testing and 3) the traditional bench test.

At the same time, year 2002, it was proposed that a consortium be set up to coordinate testing, certification and other industrial needs. The suggested idea was to set up a consortium where equipment manufacturers could be members, but were not obligated to do so. The consensus of WG1 was that all equipment must be tested and testing procedures have to be established. The consortium: Implementation Group ISOBUS was established in Europe to set the requirements and support implementation of ISO 11783. DLG became the organization to carry out conformance tests with their own tooling to test compliance to the standard—both electrical hardware requirements and software behavior.

Today, conformance tests are carried out by multiple independent organizations around the world. AEF has developed the testing tools and also defined test procedures. In practice, a manufacturer of ISOBUS equipment must be a member of AEF, in order to request testing from any laboratory. The assumption is that the results are the same, independent of the testing laboratory—thanks to automated testing tools in each laboratory being used similarly.

Functional Safety and Liability of Manufacturers

In the early years of the bus system, the functional safety around agricultural electronics was handled mostly with common sense. During this time, the bus system was not controlling any safety critical functions of implement directly, even without talking about tractor resources over a remote control. The early years of LBS and ISOBUS functions were limited to a Virtual terminal as a monitoring device, to display the status of sensors and alarms, and adjust certain parameters.

There soon came the need to control e.g. hydraulic valves of an implement over a Virtual terminal. Functional safety became very relevant to make implements and terminals that fulfill regional requirements for the machine itself; e.g. in Europe, the EU directive framework for machines (directive 2006/42/EC) and other regulations for compliance. Around years 2007-2009, the controlling of all safety critical functions, such as moving the arms of an implement, and about the ISOBUS Virtual Terminal was non-deterministic. Around times of founding AEF, this topic was defined to be solved. Remarkable steps towards making a guideline to interconnect standards ISO 25119, ISO 11783 and the European Machine Directive was achieved between 2009-2012 by the project team of AEF with support from special experts.

Functional safety was also a partial reason to refine Auxiliary Input / Function concept defined in ISO 11783-6. In the Edition 1 (2002), it was standardized in a certain way and several companies made products according to that. During the review by companies and the relation to functional safety and liability, it was found that the original concept was not well defined. This analysis led to redefining the concept of Auxiliary Input/Function; the new and old version are not

compatible. For that reason, it is possible to find in the market both Aux Input / Function devices supporting either the old or new version. AEF decided to define these as AUX-O and AUX-N, respectively. Even if products are certified according to one of them, this causes a lot of confusion throughout the farmers; e.g. if the implement is supporting AUX-N, tractor joystick is supporting AUX-O and terminal supporting AUX-O; but are they compatible? In general, they are not, but all three must be the same version. Some terminals have an option to select which one to use.

Another example of the importance of functional safety and liability is the Tractor-Implement Management (TIM). Making a standard for remote control messages and even engineering safe-states around this is not sufficient for products that can be put together by the farmer in a safe way. Let us consider a scenario that an implement is commanding tractor resources, e.g. baler commanding PTO automatically with human driver onboard tractor supervising automated system. If an accident happens and the human being is hurt seriously due to an unexpected behavior, who is then liable of damages: tractor manufacturer, implement manufacturer, or the operator that was just acting as supervisor in the cabin. Per fatal accident that has to be investigated. Assuming it was not the operator/driver; how to know retrospectively whether the failure was on the tractor side or from the implement side of electronics? In order to resolve this, AEF developed additional layers for remote control messaging.

TIM—Tractor Implement Management

As written above, the original German group preparing LBS under LAV was defined in the 1987 meeting that the new bus system should be designed so that the electronics installed to implement bus may not harm the control system of the tractor in order to keep the tractor safe for use by the operator. However, ideas to let the implement control the tractor under certain circumstances have been existing since the beginning—particularly due to popularity of the concept of “system tractor” in Germany during the 1980s, with versatile integration opportunities for implements beyond hitch and hook.

The solution was to introduce an additional class (Class 3) for the Tractor ECU (TECU) which would allow the control of tractor resources, using so-called remote-control messages. Standard Tractor ECU only broadcasts information from tractor bus to implement bus and filters all messages sent to that; except certain messages related to address management, power management and diagnostics. Tractor ECU Class 3 accepts remote control messages and uses appropriate means to use the tractor bus to control the tractor resources, instead of using normal levels in the tractor. Original functions from the tractor resources included the control of auxiliary hydraulic valves, PTO and rear hitch level. In later editions, also setpoint for cruise control, steering and front hitch have been included.

TECU Class 3 was already defined in the edition 1 of ISO 11783-7, published in 2002 and it was also included in the very first committee draft of ISO in year 2000. One of the first adaptations was made by Rüdiger Freimann as a part of his doctoral dissertation at the TU Munich during 1998-



**Figure 9. Early implement controls tractor (TIM) prototype from R. Freimann (TUM), year 2001 [21].
Photo: LTM-TUM/Reinius 2001.**

2004, to make a functional prototype of Automation of mobile machines-implement controls tractor [18] (Figure 9). Another early known demonstration using the remote-control messages was in the tractor-seed drill combination in Finland, in year 2004-2005, to control both the working position of a trailed seed drill and also controlling vertical force on the no-tillage coulters in servo control manner using an AUX input potentiometer for setpoint [19]. Technical remote-control interface is based on the same units the tractors is broadcasting to the network—percentage for hitch level, percentage for hydraulic flow, RPM for PTO shaft and m/s for driving speed. These are not the most convenient for plug-and-play system, as percentages are relational to some level that the implement does not have any information. Analysis and recommendations for engineering have been proposed in year 2010 [20].

Even if the Tractor ECU Class 3 has been proven technically functional, tractor manufacturers especially were cautious to implement it into their products in early 2000s. The technical difficulty was not the main driving factor, but uncertainty on how to design it as a part of tractor control system in order to keep the tractor still a safe product. How the driver is aware that external automation is working properly and not causing unexpected behavior for the whole tractor-implement system. Resolving these questions took more than a decade, approximately from 2008 to 2019. AEF defined guidelines for the technology which required also an additional security layer to make sure that both tractor and implement are certified and manufacturers can trust each other that the engineering has been done properly. This additional data security layer involves certificates and encryption, which we do not have space to discuss in details in this lecture—a good introduction is available [22]. A few products have been brought already to the market, the first ones in year 2020. Typical applications include remote control driving speed (cruise control setpoint) and hydraulic valve—these allow better integration of tractor-baler or tractor-loader wagon applications which are the most typical products today.

When it comes to complex software design such as security library computing known cryptographic algorithms, it is hard to write a standard that defines how to write this library in a unique way, without program code itself. In order to overcome foreseen challenges of inter-compatibility issues of different software implementations of the same cryptographic algorithms, AEF made a bold move during TIM development process—every company must use the same software library package that AEF has licensed from third party and furthermore licenses to the member companies. This new approach to harmonize the software component to one particular library implementation is a jump away from the philosophy that one may make ISOBUSa compatible product just by buying the ISO standard and make electronics and software based on that from scratch. However, the benefit of this approach is to make an industrial shortcut to harmonize one of the subsystems that is not directly related to any visible function of machinery for end users.

By this approach, ISOBUS engineers have avoided spending tens of thousands of working hours to make their security libraries compatible and were able to focus on functional inter-compatibility—like protocol to control hydraulic valves of tractor from the implement. In spite of bringing products to the market faster by this shortcut and improving practical inter-compatibility, ISOBUS has become a more closed ecosystem than ever before—ruled by AEF. The price tag of the security library is remarkable but still less than typical salary of one engineer per year. This keeps very small enterprises out of TIM business.

Standardization Process Today

As written in the history part of this lecture, standardization was done at first under organizations like ANSI/SAE (North America) and DIN (Europe; mainly Germany and neighbors). After the initialization period of ISO SC19 and its WG1, main efforts of standardization moved under ISO, since 1995 into practice. This was quite a natural change from the regional level to international level that has happened also in many other industries and not remarkable as DIN and ANSI are national representing members of ISO. All these are similar recognized bodies, at different international levels.

During 1995-2000 a parallel working towards DIN 9684 standard (LBS and LBS+) and ISO 11783 were done. Ultimately, since 2000, ISO has been responsible of defining world-wide standards for mobile agricultural electronic and regional standardization organizations (e.g. national members of ISO) have accepted those with possible translations.

When the Implementation Group ISOBUS (IGI) was established in Europe, to support unique interpretation of ISO 11783 standard series, including test methods, it was clear that IGI does “Implementation Level” documents that define on top of ISO 11783 additional requirements or recommendations—in more agile ways than the ISO process. Partially, these Implementation Level documents changed some wording in the standard to a more obligatory direction, e.g. the standard said that something “may be done,” IGI said that it “must be done”—or “shall” using standard terminology.

When AEF was founded in 2008 as “User Platform,” it was defined that it is not up to AEF to do standardization—it was clearly out of scope. AEF was not established to compete with ISO; but to fuse implementation groups of Europe and USA; and improve conformance testing, among other commercial aspects related to the ISO 11783 series—including marketing and diagnostics that were not paid attention before that across manufacturers. In this respect, it was clearly taking over commercial adaptation of ISO 11783 to products, and replacing both IGI and NAIITF.

Understanding that the community of the worldwide ISOBUS experts were limited, it was evident that the most active experts in ISO TC23/SC19/WG1 mobile electronics also became the experts of AEF the respective project team (PT3 Engineering & Implementation). Therefore, most of the experts of WG1 were also experts of AEF PT3. Despite theoretical separations of ISO and AEF, the same issues with ISO 11783 standard and its implementation were discussed in both venues of ISO and AEF in the period 2009-2014. In parallel, with regards to improving both the ISO 11783 series and its implementation documents, guidelines were defined to improve the compatibility in the field.

Historically, WG1 meetings were held in conjunction with ISO plugfests, or vice versa; and this tradition has continued with AEF plugfests since 2009. However, this tradition of having WG1 meetings along with AEF plugfest week was stopped in 2017; the last meeting was in October 2017 in Stuttgart in the same venue, just one day before the start of AEF plugfest. Today, WG1 meetings are held less frequently than before—only once a year. In earlier years, WG1 held meetings three or four times per year up until 2005, and during the period from 2006 to 2017 they were typically two times per year. Since 2017, WG1 meetings are held just once a year, in conjunction with the SC19 plenary sessions. The decrease in the number of meetings per anno clearly indicates that work is done in other venues.

AEF still states that it does not do standardization, as making standards is the duty of ISO. However, in practice this has not been true in the past few years. The same people are still in the group at different levels of ISO and AEF. In operation, the AEF project teams define guidelines that are prepared inside of AEF and after the completion, they are pushed to ISO, to go through the ISO process. The actual realization of the concept depends on the standard, also beyond the ISO 11783 series. With standards that exist and are already published at least once, the process usually works so that AEF lists their “Exceptions” to the actual standard, then the overruled sentences, changed values or annexes are “pushed” to the next Edition of the ISO standard, so that AEF exceptions are not required any more.

When it comes to a completely new standard, beyond the ISO 11783, AEF makes guidelines from scratch. It is then prepared to look like a standard and afterwards with the acceptance by AEF go to process of ISO, as a complete draft. In theory, standard could be drafted completely by AEF and in case of acceptance, ISO just adds a cover page for that. This practice was declared by the AEF and ISO leaders in AEF General Assembly in 2014. We conclude that even if AEF was not originally intended to be the standardization

organization, it has replaced the function of ISO to define standards and the direction of standardization since 2014—in practice. The consequence is that direction of standardization is now defined by large enterprises with consortiums of medium size enterprises, not by national standardization organizations, members of ISO.

When it comes to existing standards and fixing the gaps of previous editions, the practice of standards and guidelines has been functional for users of the standard. This has provided patches for the users, if we assume the users know that the current ISO 11783 standard is only up to date together with the relevant guidelines of AEF. When it comes to new standards, AEF has become a standardization organization as it prepares complete drafts of standards on behalf of ISO working groups. During the ISO process it was possible early on to influence the standard proposal, to comment on the draft in ballot inside a national committee. Now it is not possible to know what is under preparation—unless you are a member of AEF.

Simplifying, in the year 2010 ISO drafted standards and AEF made test procedures for that. In year 2020, AEF drafts the standards, including test procedure; and ISO prints it as an “International Standard.”

Virtual Terminal (VT)

The origins of Virtual Terminal were discussed in the history section of this lecture. The current Virtual Terminal concept relies on graphical user interface device with input functions for the user to enter values and press buttons. The current standard defines a limited number of object types that are used to create the graphical user interface. The atomic components include output number fields, output text fields, input number fields, but also graphical basic features as line, polyline and polygon—with a few attributes changing e.g. the fill color and line width. Bitmaps can be included to include advanced graphics, but as these costs both memory and cause scaling issues, they are not used extensively in design of user interfaces. Most advanced object types are gauge type meter and arc shaped filled bar. Simple macros can be used to program simple behaviors, like a soft press triggered data mask change.

The first editions of ISO 11783 Part 6 defined some object types as optional—it was up to the company making compatible product to make a decision on whether they wanted to include that for virtual terminal software or not. This approach has caused additional dynamic requirements for implement controller to be adaptive for any kind of virtual terminal implementation. If the plugged virtual terminal did not contain support for certain object types, the Working Set (so called VT client) had to adapt on situation and alter its design on the fly. The same applies to the number of soft keys, resolution of data mask and resolution of soft keys and number of colors—all of those are free parameters and it is up to the manufacturer to make their decision. The philosophy of optional components and optional advanced features of ISO 11783 Part 6 will be changed in the future edition towards fixed set of mandatory elements and optional object types are faded. This change will partially help user experience

and practical compatibility as all manufacturers of VT provide a similar set of support for the implement (Working Set, also known as VT client). However, the flexible number of softkeys and resolutions will stay.

Task Controller (TC)

As discussed in the history section, Task Controller was considered as extension of Farm Management Information System (FMIS), to support data exchange between the planning of farm operations in personal computer (PC) and mobile system (tractor-implement). Data exchange includes both collecting data from field operations to the computer as documentation of work, and defining tasks for the mobile system—how much and where to apply farming inputs in the field. Position specific farming a.k.a. precision farming has been the core function since the birth of the standard. Task Controller get the position from the GPS/GNSS receiver to calculate the appropriate application rate from the map that is included to the Task file that originates from FMIS. This allows the implement manufacturer to include only actuator mechatronics to the implement, while the algorithms to solve dose rate is a common function of Task Controller device/software.

Today, AEF functionality TC-GEO corresponds to the original Task Controller defined in the ISO 11783-10 standard. TC-BAS is a subset of full Task Controller, which omits all position specific requirements—most simple functionality to just collect totals of field work—e.g. number of bales or total amount of fertilizer used per field.

Section Control

Section Control as a concept was introduced independent of ISOBUS by several companies in mid-2000s, mainly to control working width of fertilizer spreaders automatically based on precision GPS, or an equivalent way in sprayer to control boom sections on/off to avoid overlap dosing. Section Control combined to automatic steering provided an excellent combination to improve field work accuracy—with help of GPS, but with no connection to ISOBUS.

As the algorithm to realize decision making for section control on/off state was common for several implement types, it was intentional to include this to ISOBUS—to let implement contain only actuators for section on/off mechatronics. This corresponds to the idea of Task Controller—which is controlling the application rate.

During the project to include section control to ISO 11783 standard, the experts ended up to reutilizing their existing protocol stack for the task controller. Reusing existing protocol (and associated program code developed by standardization experts in their companies) allowed faster introduction of section control to the standard—compared to e.g. options to make a dedicated part for ISO 11783 series and make section control as a completely independent feature.

The decision to reuse task controller protocol stack for section control led to an additional AEF functionality: TC-SC (Task Controller—Section Control). The decision makes sense in systems where one Task Controller device is controlling both application rate and sections, but has caused

problems if a farmer wants to use one device for application rate and another for section control, e.g. one of them is integrated to tractor but the other is not.

In fact, automatic section control to avoid overlap dosing does not even require any task from FMIS to function—field boundary is nice information for algorithm to have but not critical. The decision to mix task controller and section controller was driven by laziness—it offered a shortcut for standardization (easier to make a new revision of an existing part than starting a new.) Exchange of geometry parameters like boom location could be reused and less software development effort for implement controller (length of required additional program code, not much need for additional memory in controller).

Several architectural/conceptual decisions during last thirty years of Task Controller standardization effort have resulted in a standard that is hard to make compatible in practice. The standard gives so much freedom for engineers to make hierarchical device description that practical compatibility is hard to achieve in the market. It is unfortunately quite common that both Task Controller (TC Server) and implement controller (Working set / TC Client) have passed AEF conformance test, but they do not interconnect in the field. A remarkable advance was taken in 2015, when a new annex F was introduced to ISO 11783-10, which defines examples of hierarchy and usage of a few data dictionary elements. Even if the current AEF functionality (TC Gen 1.0) is based on an older version of the standard ISO 11783-10, these examples have already helped engineers to achieve better compatibility. However, very little of hierarchy is tested in the conformance test and thus both implement controllers (TC Client) and task controllers (TC Server) can pass the conformance test even if they will not work in practice.

AEF ISOBUS Database

A big step toward better information sharing was taken by AEF after the introduction of the ISOBUS database. This database contains information about all certified ISOBUS components, including tractors, display, and implements. Any farmer can register to access the database for free, to find out information on what is the compatibility status of certain product that is either in use, or under consideration for procurement. The database contains just basic information, like software version number and which functionalities were tested. Before introduction of AEF ISOBUS database and AEF test, the yellow DLG stickers just informed that something was tested to be compatible, but e.g. it was not possible to know from the sticker whether certain sprayer had any support for TC or not—investigation of which sprayer supports and which does not was a lot of work for any farmer that wanted to compare products for procurement consideration and also salespeople did not know this. The number of products and versions in the database is also a good measure for the success of ISOBUS; anyone can see which companies support ISOBUS (certified) and how many products there are in total. As the number grows all the time, it is advised that the reader checks the actual situation in the database (<http://www.aef-isobus-database.org>).

Future of ISOBUS

As we have discussed above, it took decades to come to this point where ISOBUS is part of everyday life of many farmers and hundreds of thousands of ISOBUS components have been sold worldwide. The development of tractor-implement communication system started around the same time when electronic control was introduced in automotive in general. Early discussions around the need for open communication standard bus system was rightly timed in the early 1980s, when no company had developed their proprietary technology yet. Standardization is always much more challenging if proprietary products exist in the market already by several suppliers and proposals fight against each other, as the result of the fight causes changes for market players and their need for investments. Basic ISOBUS functions, like virtual terminal, task controller (excluding section controller) and tractor ECU have been developed systematically step by step to this day following the concept laid in late 1980s and early 1990s.

Price Tag of Developing ISOBUS Compatible Equipment

In the past, the minimum costs to develop an ISOBUS compatible product was to a) buy ISO 11783 standard series and b) cover salary costs of a skillful engineer(s) and c) buy development tools to create software and hardware with some microcontroller family. Assuming the two latter ones were existing costs of the manufacturer aiming to make a component for a tractor-implement system, the main entry level cost in comparison to the homebrew system was the license for ISO documents. The current price of these ISO documents is roughly from 50 to 200 USD, per part. This price was cost effective compared to the effort of implementing that in software and hardware—a complete project may have consumed hundreds or thousands of engineering working hours plus other activity for product development of this component. However, the entry level was exceptionally low for any established business to get the open standard.

Even if the ISO 11783 standard series has not become remarkably more complicated to implement since the year 2000, several large equipment manufacturers have moved from homebrew tooling to outsourced libraries to implement ISO protocol stack. Consortia have been formed to lower costs, electronics manufacturers provide tooling for their OEM customers and independent software companies provide libraries and tools to achieve compatibility with less effort. By using these libraries and tools, OEM may achieve ISOBUS compatibility faster even if costs are slightly higher.

One important part of ISOBUS product development is the conformance test and inclusion of the product to the database of products that have passed the conformance test. This requires that either equipment manufacturer or the electronics supplier has to be a member of AEF and acquire the required license for the database—in practice. The conformance test is carried out by an independent organization but the certification process is handled using AEF systems.

In addition, AEF licenses the conformance test tool for their member companies with an additional fee. This non-

obligatory tool would help the developers to hunt bugs before carrying out the actual conformance test. AEF has also defined procedures for self-certification that is only possible after an actual successful conformance test in an independent laboratory and in the case of minor changes to the product within a limited time. Self-certification requires licensing the conformance tool and a collaboration with the laboratory that has done the original test. Self-certification will help companies to keep certification updated after changes to non-ISOBUS parts or minor changes to ISOBUS parts of the software.

During the product development process, AEF will charge their member companies. Fundamentally, the costs are for the membership, licenses for database and optionally also the conformance test tool. These costs are 5-20 times of the required ISO documents. Therefore, it could be argued that a minimum cost level to enter the market of ISOBUS compatible equipment has risen remarkably. However, the comparison to the past does not make sense as in the period of 2000-2010 there were remarkable compatibility issues in the field, the farmers were disappointed several times when compatible-claimed products did not work together and the farmer was powerless to fix it. The new era has brought the conformance test so, that there has been much more coverage and the number of issues in the field has been reduced remarkably—especially when it comes to virtual terminal.

AEF has developed conformance test tools with their subcontractors. This project has consumed a remarkable share of the budget, even if the test requirements are made by voluntary experts by the member companies. For a sustainable future of ISOBUS, it is crucial that the further developments for these tools are financed by companies that have been able to deliver products to the market successfully and sales produce revenue. ISOBUS technology contains certain common price tags that are somehow shared between manufacturers, but ultimately it is the end user that pays the bill, included in the retail price of the tractor, implement, terminal and so on. Should all manufacturers with successful products do so, there will be no advantage for any company.

Like the German academics Hans Schön and Hermann Auernhammer stated in the preface of LBS conference in 1993: “If the system is open, it is like a germ cell for communications: a continuously growing system emerges. In this way, it expands to the various tractors and machines on the farm” [7]. The approach of open system has been the key for success of ISOBUS—it is now the worldwide standard accepted by all major manufacturers. The entry level to start product development for small and medium enterprises has been reasonable and big players have not tried to eliminate small players or newcomers out of the market. It is the responsibility of large businesses and successful medium size enterprises to keep the entry level low for anyone, both as costs and a technological challenge, in order to keep the ISOBUS growing.

Future of Virtual Terminal

Our subjective experience and discussions with various stakeholders, including companies and farmers, has allowed

us to make the conclusion that the current practical compatibility with Virtual Terminal is rather good in year 2020, compared to the situation e.g. in year 2010. AEF has done a lot of work to introduce clear guidelines and test tools for test coverage for UT 2.0. This has been achieved by several experts defining test requirements, test tool developers realizing this and test laboratories running tests in a unique way. Any incompatibility of certified products experienced by farmers is a bad message for the whole technology—a problem with product made by company A and B cause challenges also for companies C, D and E to sell their ISOBUS compatibility.

The current generation UT 2.0 (ISO 11783-6 Version 3) is widely used in the market and this generation will stay compatible still for many years. The next generation has been under preparation, based on the latest published edition of ISO 11783 Part 6 (Version 6) and will be released within the next two-three years. While it will bring new features, like better fonts for non-Latin based language characters, there should be no big risk for losing practical compatibility.

Naturally, the current Virtual Terminal is very much binding to CAN bus and optimized around CAN frames. After introducing another physical layer to replace CAN bus, this optimization around CAN bus becomes questionable. The current Virtual Terminal technology (user interface component types, protocol) are specific software only for agricultural tractor-implement industry. For the future Virtual Terminal, it would be better to utilize some technology that is already in use in some other industry, while keeping it as simple as possible. Probably every ISOBUS engineer implementing ISO 11783-6 has got some ideas how to do it better, so at least there will be a lot of opinions when the architecture work for the future VT starts.

Future of Task Controller

As discussed earlier, the original intention of the Task Controller was to act as the mobile end of Farm Management Information System (FMIS) and allow exchange of farm data between the vehicle and the computer at a farm. Times have changed since the end of 1980s when PC’s started to arrive to homes and farms—now it could be even said that PC’s are leaving farms and are replaced by cloud systems and FMIS can be used with any mobile device having web browser or app. As times evolve, the needs for standard also change.

For the first level of ISOBUS introduction to farmers in 2000s, the most important feature was Virtual Terminal—this was the leading sales argument to tidy the cabin by using one display for all implements. Task Controller was not on the leading edge of arguments, even if several companies had compatible products for that. Several reasons for this existed—now there is both the need for precision farming and sales organizations to understand the ecosystem better.

However, our opinion is that the Task Controller is not a vital concept for the future by extending it any further. The first step towards this unsustainable road was taken when section control was included as an extension for the original task controller—this caused an additional degree of freedom

for options for components. Basically, implements may support either only Task Controller (known as TC-GEO), only Section Control (known as TC-SC) or both. This requires that TC Server manufacturer has to design and test support for all three alternatives, instead of one.

During the 2010s, there have been several proposals to include additional features to the standard and for some reason several experts want to push them as extensions for Task Controller:

- Data exchange between TC and guidance system. One of such a proposal has been the introduction of the exchange of guidance system data through TC. Basically, guidance lines could be organized/planned in FMIS and delivered to the mobile system using TC; and furthermore, this information should be exchanged in the mobile system between TC and a separate guidance system over CAN bus. This may work within systems of the same manufacturer, but not in multibrand TC—Guidance. No progress in standardization recently.
- Telemetry data logger. This has been already included in the current standard—and the original Task Controller was again reused for this telemetry purpose. Data logger is defined in the latest edition of ISO 11783-10 (TC version 4), but industrial adaptation not common due to general challenges of TC. Protocol wise the data logger can be defined as task-less read-only task controller server.
- Peer control. The idea is to use tractor mounted sensor (e.g. crop sensor) to control directly the application rate of connected implement (e.g. fertilizer rate), without using any application/prescription map. The approach does not limit application only to crop sensors and fertilizer—any ISOBUS connected sensor could be connected to control application rate—if just the units match (e.g. kg/ha → kg/ha). This “peer control” has been introduced in the latest standard edition (TC version 4), but nobody knows which companies have support for that and which do not—also there is no conformance test tool for that; nor AEF functionality.
- Tramline control. This proposal is to let Task Controller monitor or control the tramline creation, usually related to planters/seeders. Laying tramlines with wide planter may be quite cumbersome for the driver to handle and standardized automation for that would be beneficial—together with automatic steering, section control and (original) task controller. Sketches and proposals for DDIs have been made, but no progress in standardized concept.
- Control of working width. Adjustable working width of non-boom implements, such as a plough, for seamless operation would be desired. Variable width tools, such as a plough with electro-hydraulic servo control would benefit interlinking to GNSS and automatic steering. This kind of non-ISOBUS innovations have been introduced by a few companies already, but it is not possible to control working width with any standard device. Proposals to realize this with Task Controller-Section Control (TC-SC) have been made.
- Implement steering/guidance. In tractor-implement sys-

tem, usually the tractor is the one that has automatic steering capability, and implement is passively following. Some proprietary innovations are available for farmers to control both tractor and implement actively, based on GNSS, but there is no means to do that in multi-brand system. Guidance system and tractor steering controller can interact using ISO 11783-7 messages, currently part of TIM, but there is no standard coverage for implement steering, or implement guidance overall. Non-TC based approach has been proposed [23] instead of reusing TC protocol.

Extending the original Task Controller due to laziness to introduce new parts for the standard, or new functionalities will cause more and more confusion of what is Task Controller. Together with the current practical inter-compatibility problems, it is foreseeable that it becomes more and more challenging to keep the standard stable.

The reasons for incompatibility are not only lack of architectural work and laziness, but also in fundamentals of task controller and plug-and-play design made in earlier years. Retrospectively it is easy to say that originally the standard should have defined standard device profiles for implements. Industrial automation groups have been defining device profiles (e.g. DeviceNet or CANopen) to harmonize the key parameter exchange for common device types, like AC drives or pumps, for instance.

It would have been much better compatibility today, if in the early 2000s the most typical task controller application would have been “strongly type defined” as TC device profiles. Still today, the most typical ones are seeders/planters, fertilizer spreaders and sprayers—with very limited subtypes. Device profiles such as: a) pneumatic trailer seeder, b) mounted seed drill, c) air cart seed drill, d) potato planter, e) mounted sprayer, f) trailed sprayer, g) mounted disc spreader, h) mounted boom spreader and i) trailer disc spreader would have covered most TC compatible implements in the market.

Along the way, new device profiles could have been defined. This sort of device profiles would have allowed each engineer to design their device description, to include mandatory required elements (even as not-available signals) in exactly the same way and making a conformance test and certification would have been straightforward.

Our suggestions for future standardization of Task Controller related-subjects are two folded: 1) Keep the original Task Controller untouched and introduce new data exchange needs for separate protocols, 2) Introduce device profiles for future versions of Task Controller.

There is an opportunity to make this revitalizing Task Controller one day when CAN bus is replaced with some other physical layer. At the next generation, there should be courage to break backwards compatibility as-is, and redefine the whole concept of TC and related functions for the next twenty years. Task controller should only act as exchange between FMIS and mobile system, and other systems such as Section Control or Implement Steering should be considered as completely separate and independent of this and perhaps grouped under new “Automation Controller” scheme.

High Speed Backbone for Tractor-Implement Communication

The standardization group has realized the need for more bandwidth years ago. WG1 initiated the work in the meeting on 28 March 2012 by setting up a new Task Force to prepare the future of mobile electronics standardization; beyond CAN bus based ISOBUS. This group studied options to replace CAN bus and the main options were either the use of CAN FD (which was just released) and various Ethernet based technologies. It was soon identified that CAN FD does not provide remarkable improvement for new functional needs in the tractor-implement system and the focus turned to one-pair ethernet and using some existing industrial ethernet for MAC layer. At that time, the goal was to find an alternative for CAN, mainly for OSI layers 1-3, and utilize IP technologies on top of that. The result of the work was an analysis of existing technologies and there were numerous different options for industrial ethernet and no consensus was achieved which one would serve the best. In addition, there was no findings how to use them in such hot plug-and-play manner as a CAN bus based ISOBUS.

The preparatory work was moved from ISO WG1 to AEF and a new AEF Project Team 10 was founded in July 2014. This disbanded Task Force of WG1. In this new group, several more experts from Germany joined, but the goals were still similar. This work was more systematic in order to identify the use cases needing higher bandwidth and/or smaller latency and higher frequency. During the years from 2014 to 2020, there were quite a limited number of decisions in spite of numerous meetings.

Today, there is a large consensus about the architecture, how the new high-speed bus would lie in parallel with ISO-BUS, with gateways, required switches and locations of connectors. The connector is being prototyped and a supplier is selected enabling the sketching of other cabling requirements. There is also a large consensus that the new bus will have one-pair ethernet, used in the automotive industry—but there are different flavors and these will cause debate. However, the largest open item is the protocol. It would be possible to use just Ethernet to deliver IP packets and design a complete ISO protocol on top of that. In a similar way as ISO 11783 & SAE J1939 was created on top of CAN bus, just utilizing CAN frames to broadcast small packets of data and make ag industry specific protocol for functions.

The project team has tried to find an existing middleware out of available technologies that would eliminate the need to write a new extensive standard series and also eliminate the need for companies to program the whole protocol stack only applicable for this industry. The group has studied options used or emerging both in Industrial automation and Automotive industry. So far, two prototype implementations have been presented in the group, one representing each industry [24].

Aalto University [25] made a functional prototype in a research project, during 2018-2019, by using OPC UA over Ethernet, to realize existing ISOBUS functionalities of TC-GEO (server and client), TC-SC (server and client), TECU (server and client) and GNSS receiver—mapping these to OPC UA framework and take the benefit of the built-in

mechanisms, like provider/subscriber and hierarchical representation of the data; as the current device description object pool for TC. Figure 10 illustrates software components and interactions of this functional prototype [26].

OPC UA as a middleware for High Speed ISOBUS would essentially offer built-in information modeling and dedicated protocols like for DDOP exchange are not any more needed as it could be embedded as digital model and data exchange would be automated. OPC UA seems to suit well for functionalities like Task Controller, TECU (including TIM) and GNSS which are similar as factory automation process data, but future extensions of OPC UA to new functionalities like cameras are unknown and need to be investigated. In addition, even if middleware from industrial automation would work as is, embedded realizations of protocol stack feasible for electronic control units typically used in agricultural business are question marks—including real-time performance [25].

Robert Bosch GmbH also made a prototype in years 2019-2020, to implement TC-related DDI exchange by using SOME/IP over Ethernet; with AUTOSAR adaptive. This was proofing how SOME/IP can be used with AUTOSAR tools, to reduce complexity of ISOBUS functionalities and take the benefit of middleware. SOME/IP used together with AUTOSAR tooling offers service-oriented architecture and the demonstration has shown how to set and get DDI values over tractor-implement interface.

One of the challenges seem to be searching a shortcut for the next generation backbone, by selecting some existing protocol as the middleware, under changing requirements. The decision for the middleware is much more complex than compared to the decision to go for CAN bus in 1988, as it will be a strong binding for the next 30 years. The more dynamic and the more limited the middleware is, the more challenging it is to make the new tractor-implement communication protocol on top of that, over the lifetime of vehicles.

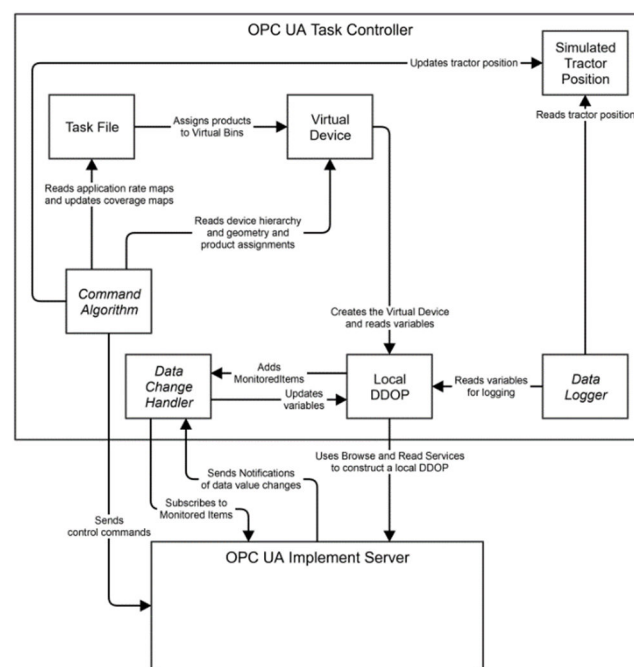

Figure 10. OPC UA Task Controller and OPC UA Implement Server [26].

Especially, middleware originating from ICT industry are so dynamic and loosely standardized that there is no certainty that these protocols created by IT companies will be the same after some years. For any Internet connected computer or device that is not a big deal, as they can be updated all the time for the latest drivers, but tractors and implements are not traditionally considered as such. If all tractors and implements are connected to Internet, then it could be possible, but this would lift requirements for OEM remarkably to enter this new technology.

The decision which technology will be used as the backbone for the next generation tractor-implement communication system will have consequences for OEM business landscape as well as for their suppliers. Open system and open standard should still be the mandatory requirement for the next generation communication. High start cost due to special licenses, expensive development tools, and memberships for organizations in order to join the ecosystem in practice would definitely eliminate small and regional enterprises to make innovations and compatible products. The goal should be to find a middleware that offers license free technology, reasonable priced tools to make products in practice (not only in theory) and reasonable development effort for anyone to learn how to make it.

High speed backbone also requires a physical layer: cables, connectors, chips and switches. Based on the current achievements of AEF project group, it seems that connectors and cables are easier decisions than the protocol—relatively speaking. In many aspects, the developments and discussions during the period 2012-2020 have been similar to that which were faced during the period 1989-1995, when fundamental requirements had to be agreed for the ISOBUS. The main difference is that today a vast number of technological options are available that would offer a shortcut compared to ISO written protocol stack.

In this lecture, we focus on the hard-wired communication protocols, but it is worth mentioning that in a modern vehicle control system the communication protocol is closely related to software development methods and these modern embedded software development tools can generate code which is also related to communication, messages and addressing—and testing. This approach is already used by the vehicle industry in stand-alone products, but using these methods for multi-brand hot plug-and-play modular system is not possible directly. Therefore, we need open standards—that are suitable for modern software development tools. This trend was noticed already in 2008, by Marvin Stone et al. [1] and realized with Simulink (Mathworks Inc.) in [27].

Future of CAN Bus as The Base for Tractor-Implement Communication

As written above, the earliest decision to use CAN bus for open bus system between the tractor and an implement was made in May 1988. A lifetime of over 30 years is impressive for any modern electrical technology. However, the lifetime expectation in general is similar within small family farms for agricultural machinery. For instance, many tractors built in 1990 are still part of an agricultural production somewhere.

It is foreseeable that tractors may use progressively other alternatives to the CAN bus as the internal communication system to connect the subsystems of tractor. Electrification and increasing usage of automotive components will drive this transition or have already done so. In addition, the amount of software is constantly increasing and challenges are similar to that faced of the automotive industry a decade ago.

For several implements, the current CAN bus based ISO-BUS is still a cost-effective option. After gaining experience over the past 15 years of ISOBUS and optimizing the production and service tools for this technology, the current technology is sufficient for many small implement manufacturers, in their implement products. In order to jump from CAN bus based ISOBUS, to Ethernet based High Speed option, the benefits should be remarkable in order to stay competitive in the market. In certain type of implements this offer improved performance for the end user—for instance a premium wide boom sprayer utilizing high frequency section control with on-the-fly vision sensors for spot spraying. However, for several electronically simple implements, like tillage equipment, complete transition from CAN bus to a new technology would just increase development and production costs. Transition will take a long time anyway—so we can expect clearly more than ten years life time for CAN bus based ISOBUS.

Conclusions

ISOBUS has been a success story; not only in the field of agricultural electronics, but also widely across industries. For instance, various standardization projects since the 1980s in industrial automation or factory automation have never been able to deliver common wired communication standards that would have had acceptance by the supermajority.

There have been many keys for success of ISOBUS. One of the keys is the long tradition for standardization across agricultural machinery, in the fields of mechanical and hydraulic interconnection and interchangeability. The agricultural machinery industry has been following various standards prior to the electronics and ISOBUS, but also processes to prepare new standards were familiar for many businesses.

Another key has been several open-minded engineers working in their companies, trying to find the best technological solution for the whole industry and pushing these forward—instead of protecting their own developments. Occasionally, agricultural electronics standardization has suffered from this attitude, by some large enterprises, but in the big picture agricultural machinery industry has been consensus seeking and voting has been avoided in any ISO meetings. Voluntary experts have contributed for the standardization for hundreds of thousands of hours, mostly sponsored by their employers. It is often taken for granted that these great individuals are committing their effort for the best of the industry. Some experts have acted as paid soldiers for their enterprise to attack and defend, but most experts in standardization groups have been seeing the entire perspective and issuing the best results for the end users. Understanding the

needs of the end users in different regions have shaped the standard to cover relevant use cases. In this lecture, we have mentioned a few names from the early days contributing to the success with their passion to create fundamental pieces of ISOBUS. Today the society has grown to so many people that it is not easy to find a large enough room that could accommodate all active experts that spend their working time and sometimes also a bit of their free time to contribute on tractor-implement electronics standardization.

Another special trait from the community of ISOBUS engineers has been that standardization is a common goal for the functional system. This attitude has been seen in all plugfests where competitors help each other to find irregularities in the communication compared to the standard and hunt the bugs so that both devices in pair testing become functional against each other. Certain openness is required in order to find the reason and it is often not possible to know from which device the problem is arising—hunting the bug is a common problem. In some cases, this has revealed gaps in the standard and these experiences are communicated to the standardization group to improve unique interpretation. Thanks to the plugfest concept, the engineers from different companies have also come to learn and know engineers of peer products. In certain cases, this helps if the end user reports a problem within a certain combination of equipment.

A small community of ISOBUS experts also has its downside. Especially in earlier years, the standard was written in such a compact format that the intention of usage of specific messages was only known by the standardization group whom had written it. For a random person buying the standard, it was not always possible to know the background discussions that had resulted in certain sentences for the standard. This applies both for individual signals or messages as well as complete parts—like file server. File server (Part 13) defines messages for data exchange but no information for which purpose this standard is intended to be used, or what is the role in the system. This challenge was realized about ten years ago and for this reason, several parts of the standards have grown in length, as steadily more implementation notes are included; as recommendations to the developers. In addition, better guidelines and automated test procedures have helped engineers to follow the standard in a unique way.

As quoted earlier, a system grows if it is open. This has been the key for success of ISOBUS. Let ISOBUS be equally open for large, medium, small and micro enterprises, also in the future.

References

- [1] Stone, M.L., Benneweis, R.K. and Van Bergeijk, J., 2008, Evolution of Electronics for Mobile Agricultural Equipment. Transactions of the ASABE, Vol. 51(2), pp. 385-390.
- [2] Dais, S., Kiencke, U. and Litschel, M. History of CAN technology. <https://www.can-cia.org/can-knowledge/can/can-history/>, downloaded 2021-01-08
- [3] Jahns, G., and H. Speckmann, 1984. Agricultural electronics on farm machinery needs standardized data transfer: a concept. ASAE Paper No. 84-1633. St. Joseph, MI: ASAE
- [4] Searcy, S.W. and Schueller, J.K., 1986. Tractor-implement interface: a communication link whose time has come? Agricultural Engineering, pp. 12-13
- [5] DIN 9680, 1991. Agricultural tractors and machinery—Electric power transmission—Dimensions, requirements
- [6] DIN 9684-1, 1997. Agricultural tractors and machinery—Interfaces for signal transfer—Point-to-point connection. Berlin, Germany: Beuth Verlag (ISO 11786: 1995 modified)
- [7] Auernhammer, H., and J. Frisch (Eds.), 1993. Mobile Agricultural BUS-System—LBS. Münster-Hiltrup: Landwirtschaftsverlag, KTBL Work paper 196, <http://mediatum.ub.tum.de/?id=683691>
- [8] DIN 9684, 1997. Agricultural tractors and machinery—Interfaces for signal transfer. Berlin, Germany: Beuth Verlag (parts 2 to 5, different years)
- [9] Auernhammer, H., 1989. The German Standard for Electronical Tractor Implement Data Communication. In Sagaspe, J.P. and A. Villeger (Eds.), AGROTIQUE 89, Proceedings of the Second International Conference, September 26–28, 1989, Bordeaux, France, pp. 395–402 (ISBN 2-87717-012-8), <http://mediatum.ub.tum.de/?id=736666>
- [10] Auernhammer, H., 1993. Requirements for a Standard for Tractor-Implement-Communications. ASAE Paper No. 93-1532. St. Joseph, MI: ASAE
- [11] N.N., 1993. Winter Meeting Standard Activities Attracts International Attendees. Within ASAE, 11, 1, p. 3
- [12] Auernhammer, H., 1997. Elektronische Traktor-Gerätekommunikation LBS. In: Proceedings of the International Symposium on Mobile Agricultural Bus-System LBS and PA for the Large-Scale Farm Mechanization. Sapporo: Hokkaido Branch of the Japanese Society of Agricultural Machinery 1997, pp. 1-22 (German); pp. 23-38 (Japanese)
- [13] Spangler, A. and Auernhammer, H., 2000. Die LBS Programmbibliothek—erstes Open Source Modell in der Landwirtschaft. {Japanese translation by T. Kataoka} In: Proceedings of the 2nd Sapporo International Symposium 2000: Electronic Farm Communication with LBS. Hokkaido (Japan): Hokkaido Branch of JSAM 2000, pp. 89-115
- [14] Auernhammer, H and Speckman, H., 2006. Section 7.1 Dedicated Communication Systems and Standards for Agricultural Applications, pp. 435-452 of Chapter 7 Communication Issues and Internet Use, in CIGR Handbook of Agricultural Engineering Volume VI Information Technology. Edited by CIGR--The International Commission of Agricultural Engineering; Volume Editor, Axel Munack. St. Joseph, Michigan, USA: ASABE (doi:10.13031/2013.21693)
- [15] Stone, M L., D. M. Kee, C. W. Formwalt, and R. K. Benneweis, 1999. ISO 11783: An Electronic Communications Protocol for Agricultural Equipment: ASAE Distinguished Lecture # 23, Agricultural Equipment Technology Conference, 7-10 February 1999, Louisville, Kentucky USA. 913C1798
- [16] Spangler, A., Auernhammer, H. and Demmel, M. 2001: Stimulating use of open communication standards in agriculture (DIN 9684 and ISO 11783) with capable Open Source Program Library as possible reference implementation. In: Proceedings of the Third European Conference on Precision Agriculture (Eds.: Grenier, G., Blackmore, S.), agro Montpellier 2001, Vol 2, pp. 719-724
- [17] Huebner, R., 2002. Inspections of agricultural BUS-Systems. In: Conference Agricultural Engineering. Düsseldorf: VDI-Verlag, pp. 199-204
- [18] Freimann, R., 2004. Automation mobiler Arbeitsmaschinen—Gerät steuert Traktor. Fortschrittbericht VDI Reihe 14, Nr. 116, VDI-Verlag Düsseldorf
- [19] Oksanen, T., Öhman, M., Miettinen, M. and Visala, A., 2005.

- ISO 11783 standard and its implementation. In Proceedings of 16th IFAC World Congress. 4–8.7.2005. Prague, Czech Republic, pp. 69-74. IFAC.
- [20] Oksanen, T., 2010. Closed loop control over ISO 11783 network – challenges of plug-and-play. In Proceedings of the third IFAC International Conference Agricontrol 2010, Kyoto, Japan, 6–8 December 2010. pp. 203–208.
- [21] Freimann, R. and Fellmeth, P., 2001, Prüfung der Kompatibilität von CAN-Netzwerken zur ISO 11783 durch Simulation. (Investigation on the compatibility of CAN networks with ISO 11783). Tagung Landtechnik, Hannover 9.-10.11.2001. VDI_Bericht 1636, pp. 89-94. (German)
- [22] Happich, G. and Nissen, H.J., 2017. ISOBUS Automation—On the Road to TIM. In the Proceedings of AgEng—VDI Landtechnik conference, Hannover, 2017, 8 p.
- [23] Oksanen, T. and Backman, J., 2016, Implement Guidance model for ISO 11783 standard. IFAC International Conference Agricontrol 2016, Seattle, USA. In the Proceedings of 5th IFAC International Conference Agricontrol 2016, Seattle, USA. IFAC-PapersOnLine 49(16), Elsevier, pp. 33–38.
- [24] Smart, D. and Brill, V., 2019, High Speed ISOBUS, an AEF Project for next generation Ag networking. In the Proceedings of AgEng—VDI Landtechnik conference, Hannover, 2019, pp. 91-106.
- [25] Siponen, M., Seilonen, I. and Oksanen, T., 2020, Modelling and Simulation of Tractor-Implement Automation using OPC Unified Architecture for Next Generation ISOBUS. Aalto University publication series SCIENCE + TECHNOLOGY, 1/2020. 45 p.
- [26] Siponen, M., 2019, Next Generation Task Controller for Agricultural Machinery using OPC Unified Architecture. Master's thesis, Aalto University, School of Electrical Engineering. 118 p.
- [27] Oksanen, T., Kunnas, A. and Visala, A., 2011, Development and Runtime Environment for Embedded Controller supporting ISO 11783 standard. In Proceedings of the 18th IFAC World Congress, pp. 2895-2900.